



CHATSWORTH
PRODUCTS

V.30

PRODUCT CATALOG



Chatsworth Products is more than just a manufacturer, we **enable** the **digital technologies** in your everyday life.

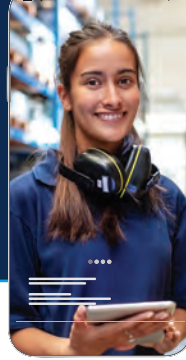

CPI Website

Visit Chatsworth Products' (CPI) website at chatsworth.com to find, filter and compare thousands of products, as well as view documentation, create a shopping cart and purchase from an authorized CPI partner. You will also find product configurators, selectors, estimators and downloadable design tools.



Online Chat

The CPI website now offers online chat for customers who need assistance while using our website. You will benefit from one-on-one, real-time interaction with CPI's helpful employees.



CPI Product Designer

Many of our enclosures can be configured online using the CPI Product Designer. CPI Product Designer will generate bills of material, drawings, 3D models and sales documents automatically. Once the design is finished, you will receive a confirmation email with the product's description, part number, and bill of material with pricing and related documents. Visit chatsworth.com/product-designer.



Power Selector

Visit selectapdu.com to select the best power product for your application by narrowing down options based on your requirements. You can compare several products at one time and then email or print the results.



CPI Video Library

Take advantage of the many videos on video.chatsworth.com. You'll find helpful how-to videos, product feature videos and solution overviews.



On-Demand Courses

CPI offers courses that have been approved by BICSI and the American Institute of Architects (AIA) for continuing education credits (CECs). These courses are presented by CPI's highly-trained and experienced professionals. Visit chatsworth.com/cec-courses.

Introduction	Pages i–ix
Cabinets & Containment	Section 1
Racks & Cable Management	Section 2
Power Monitoring & Security	Section 3
Bonding & Grounding	Section 4
Cable Pathway	Section 5
Industrial Enclosures	Section 6
Wireless Enclosures	Section 7
Index	Section 8



Powering and
protecting your
technology investment.

From the data center to the edge, Chatsworth Products (CPI) is more than just a global manufacturer of products and solutions that protect your ever-growing investment in information and communications technology for IT and industrial automation applications. We're a 100% employee-owned, U.S. based organization that's building a better digital future—one rack, cabinet and PDU at a time.

As a trusted business partner, we are uniquely prepared to respond to your requirements with global availability and rapid product customization, giving you a competitive advantage. With more than 30 years of experience engineering thermal, power and cable management solutions for the data center, enterprise networking, wireless and industrial enclosure markets, CPI is well positioned to provide you with unequalled application expertise, customer service and technical support, and a global network of industry-leading distributors.

To know Chatsworth Products (CPI) is to know our motto – “Delight the Customer.” As an employee-owned company, it is important for us to work with you on an individual basis to deliver quality products and services that power and protect your technology investment. Whether you are placing an order through customer service or clarifying a project through technical support, CPI’s team of experienced professionals will help find a solution that works best for you and your business. This dedication to solving the needs of customers allows us to showcase our most popular products for ICT infrastructure solutions in this catalog. If there is something you cannot find, give us a call at 800-834-4969, and we will be happy to delight you too!

What We Do

CPI is a global manufacturer of products and solutions that power and protect your ever-growing investment in information and communications technology for IT and industrial automation applications. We are a trusted business partner, and are uniquely prepared to respond to your requirements with global availability and rapid product customization, giving you a competitive advantage. With decades of experience engineering thermal, power and cable management solutions for the data center, enterprise networking, wireless and industrial enclosure markets, CPI is well positioned to provide you with unequaled application expertise, customer service and technical support, along with a global network of industry-leading distributors.

Headquartered in the United States, CPI operates from multiple sites worldwide, including offices in Mexico, Canada, China, Qatar, the United Arab Emirates and the United Kingdom. CPI’s manufacturing facilities are located in the United States, Asia and Europe.



WHY CHOOSE CPI?

History

CPI began in 1991 when 90 employees joined together and purchased the Dracon Division of Harris Corp. using an Employee Stock Ownership Plan (ESOP). With deregulation in the telecommunications industry and technological innovation in voice and data equipment, CPI focused on the explosive needs of the information technology market to manage IT infrastructure equipment. Today, CPI is a leading global supplier of integrated solutions that optimize information and communications technology (ICT) equipment, including power management solutions and industrial enclosures.

Who We Serve

Whether it is supporting a small network or a large data center, CPI has the experience and know-how to provide the right solution at the right time.

Some of the markets we serve include:

- Banking & Financial Services
- Education
- Electronics
- Government (Federal, State and Local)
- Health Care & Medical
- Hyperscale
- Industrial
- Information Technology
- Insurance
- Manufacturing & Automation
- Media & Entertainment
- Multitenant/Colocation Data Centers
- Pharmaceutical & Biotech
- Real Estate
- Retail
- Security
- Telecommunications
- Transportation

CPI is committed to being a company of the highest quality in every aspect of its business, providing Quality Products, Quality Services and most of all—Quality People.

Customized Solutions

A great deal of thought and precision goes into the design of today's enterprise networks, however, plans can change in an instant. Each step comes with its own set of obstacles, from a need to maintain energy costs through thermal management solutions, to the deployment of quality-built cabinets that can withstand high-density loads and earthquakes. The data center environment is continually changing, and infrastructure systems must be capable of adapting in sync. That is why CPI provides the marketplace with high-quality, scalable solutions that allow for future technology and evolving standards.

Leading the Way in Research, Development & Training

With the financial strength to reinvest in the company and continually improve manufacturing and logistical processes, CPI has become an industry leader in product innovation and excellence. Complementing our numerous patents for groundbreaking product designs, CPI has its own Research Development and Training (RD&T) Center in Georgetown, Texas. Designed with customers in mind, the RD&T Center is a comprehensive facility complete with a Product Showroom, Customer Meeting Center and state-of-the-art training facilities.

Additionally, CPI product showrooms are located around the globe to provide our customers the opportunity to inspect our products, and see the functionality and quality firsthand. For more information or to schedule a visit to one of our showrooms, visit chatsworth.com.



Value-Added Online Tools

CPI considers every aspect of project planning, providing the tools and resources our customers need to get the job done. CPI provides a robust set of design tools on our website at chatsworth.com to help you plan designs and solutions for any IT infrastructure need. These tools include the CPI Product Designer, Building Information Modeling (BIM) drawings, CAD Blocks, Visio® Shapes, and much more.

Thought Leadership

CPI supports the thought leadership, standards development and knowledge-sharing activities of the following industry associations:

- Association for Computer Operations Management (AFCOM)
- Building Industries Consulting Service International (BICSI)
- Employee-Ownership (ESOP) Association
- International Organization for Standardization (ISO)
- Community Member of the Open Compute Project™
- Telecommunications Industry Association (TIA)
- Underwriters Laboratories, Inc.
- Uptime Institute



Expert Service and Support

CPI understands that the high-speed world of data management is constantly changing and for this reason, we offer highly trained Technical Support Specialists and Customer Service Representatives who are ready to assist quickly and accurately to keep your project on track. To further support your IT infrastructure needs, CPI Sales Managers and Field Application Engineers are available to meet with you onsite, discuss your business needs, assess your current infrastructure and recommend solutions that will gain you the best return on your investment.

CPI GLOBAL OFFICES:

Global Headquarters - Simi Valley, CA

818-735-6100 • 818-735-6199 FAX
chatsworth.com



New Bern, NC Operations

252-514-2779 • 252-514-2977 FAX



Georgetown, TX Operations

512-863-7800 • 512-869-1374 FAX



Round Rock, TX Technology Center

737-808-9200



Canada

Vaughan, Ontario, Canada
+905-850-7770
chatsworth.com



Asia Pacific

Jing'an District, Shanghai, China
+86-21-6880-0266
chatsworth.com.cn



Latin America

Mexico City, Mexico
+52-55-5203-7525, toll free: 800-201-7592
chatsworth.com.co



Europe

Buckinghamshire, England, United Kingdom
+44-01628-524834
chatsworth.com



Middle East & Africa

Dubai, UAE +971-4-2602125
Doha, Qatar +974-4-267422
chatsworth.com



State College, PA Oberon Operations

814-867-2312 • oberonwireless.com

For answers to your questions or for custom solutions, please call Customer Service or Technical Support at:
1-800-834-4969 (toll free in the U.S. & Canada)
Monday - Friday, 5 a.m. - 5 p.m., Pacific Time
1-818-739-3400 (outside of the U.S. & Canada), or email Technical Support at techsupport@chatsworth.com

HOW TO ORDER

CPI sales are conducted in partnership with a global network of distributors, contractors and resellers. Whether visiting your local distribution center, or ordering online, CPI offers a variety of methods to procure what you need and access to the people and systems to help you stay informed during the order and procurement process. To obtain a purchase price quote and product availability, please locate the CPI partner nearest you by calling 800-834-4969.

This catalog has been developed according to comprehensive product groups. Each group is presented as a convenient section within the catalog and contains part numbers, ordering information and detailed illustrations or photographs.

To Order, Follow These Steps:

1. Locate desired product(s) within the appropriate section.
2. Use the complete part number. Pay close attention to the digits indicating product variations such as size, finish (refer to Color Finishes information) and hole pattern.
3. Check "Kit includes" information of each product for a listing of all components and hardware included with the part number.
4. Check to see if product descriptions include "Order Separately." These components are not included with the product; however, most of these items are contained in the catalog and may be ordered. Please see part number references where indicated.
5. Indicate quantity and full part numbers in your purchase orders (POs). The description is not essential but should be included when ordering. The product description will appear on your acknowledgment, invoice and packing list.
6. Locate a distributor by calling 800-834-4969 or visiting chatsworth.com. If you are an authorized CPI distributor, send POs via email or fax to one of our Customer Service Department locations listed to the right.
7. Questions? Call CPI toll free at 800-834-4969 within the United States and Canada, or visit chatsworth.com.

Note: Prices and quantity breakdowns are not listed in this product guide.

For product pricing, please contact our Customer Service Department at 800-834-4969.

All orders received are subject to acceptance by CPI and are subject to a minimum charge of \$200.00. CPI must receive written confirmation for all orders prior to shipment.

Products listed do not include export packaging, insurance, taxes, tariffs or duties.

All pricing is subject to change. CPI reserves the right to make adjustments to pricing and product offerings for reasons including, but not limited to, changing market conditions, product discontinuations, product unavailability and price changes.



Federal, State and Local Government Business GSA Contract No. 47QTCA23D0033

CPI is listed with the General Services Administration (GSA) under Federal Supply Schedule 70 for General Purpose Commercial Information Technology Equipment, Software and Services, is a Small Business manufacturer (SB) and is available through GSA Advantage, NETCENTS, SEWP III, NITAAC-ECSIII, GSA Connections, as well as other channels.

Color Finishes

CPI utilizes a powder-coating finishing process to produce a durable, long-lasting finish that is aesthetically superior to other techniques. The majority of CPI Products are available in three colors (white, black and gray) and a grained metal finish referred to as "clear." CPI's powder-coating and curing techniques provide a more consistent, uniform finish. Therefore, the color is evenly applied (even on angles, die cuts or unique shapes) and does not vary among different products.

Customer Service Departments

Simi Valley, CA Operations

Ph: 818-735-6100 • Fax: 818-735-6199

Georgetown, TX Operations

Ph: 512-863-7800 • Fax: 512-869-1374

New Bern, NC Operations

Ph: 252-514-2779 • Fax: 252-514-2977

Toronto, Canada Office

Ph: +905-850-7770

Shanghai, Asia Pacific Office

Ph: +86 21 6880-0266

Mexico City, Mexico Office

Ph: +52-55-5203-7525

Buckinghamshire, England Office

Ph: +44-1628-524-834

Dubai, UAE Office

Ph: +971-4-2602125

Doha, Qatar Office

Ph: +974-4-4267422

Oberon, a division of Chatsworth Products

Ph: 814-867-2312

1-800-834-4969 (toll free in the U.S. & Canada)

1-818-739-3400 (outside of the U.S. & Canada)

TERMS & CONDITIONS

CPI maintains a policy of continuous product improvement; therefore, we reserve the right to make changes without notice.

Products listed are F.O.B. Destination, prepaid and add to locations within the 48 contiguous states and do not include export packaging, insurance, taxes, tariffs or duties. For complete freight program details and information regarding export shipments, contact our Customer Service Department at 800-834-4969 in U.S. and Canada or 818-739-3400 outside U.S. and Canada.

All orders received are subject to acceptance by CPI. All orders are subject to a minimum charge of \$200 USD net per shipment. CPI must receive written confirmation for all orders prior to shipment. Payment Terms are Net 30 days or otherwise confirmed on orders.

WARRANTY

CPI-Branded Hardware Products

CPI warrants all CPI-branded hardware products to be free from defects in material and/or workmanship (CPI's Standard Limited Warranty) for a period of three (3) years following the date of purchase (the Original Warranty Period). The customer must contact CPI in writing or by oral communication confirmed in writing within the Original Warranty Period to report a product that the customer claims is defective. CPI reserves the sole and absolute right to determine whether or not the product or any part thereof is defective. In the event a product (or any part thereof) is determined by CPI to be defective (an Accepted Claim), CPI will provide a remanufactured or replacement product or part (the Replacement Product) at no cost to the customer and issue a Return Material Authorization (RMA) number.

In the case of an Accepted Claim, the customer shall be responsible for shipping back the defective product to CPI under the provided RMA number within 30 days following receipt of the Replacement Product. If the customer fails to do so, CPI has the right to invoice the customer for the price of the Replacement Product. Any exceptions to this return policy must be authorized by CPI in writing in advance. Freight charges for the return shipment of the defective product for an Accepted Claim shall be borne by the customer, unless the defect is reported by the customer to CPI in writing within the first 30 days following the customer's receipt of the original product. Any Replacement Product that has been provided under an Accepted Claim will be subject to CPI's Standard Limited Warranty for the remaining Warranty Period applicable to the original product or 90 days following the date of replacement, whichever occurs later.

CPI's Standard Limited Warranty and Extended Limited Warranty do not extend to CPI-branded hardware products that have been subjected to abuse, misuse, neglect, accident, improper use, or improper installation, operation, repair and maintenance (except to the extent provided by CPI authorized personnel), nor to products that have been altered or modified in any way by anyone other than CPI authorized personnel, in which case CPI's Standard Limited Warranty or Extended Limited Warranty shall be null and void. In no event will CPI will be liable for consequential damages, for loss, damage or expense directly or indirectly arising from the use of any of its branded products, for any inability to use materials or from any other cause.

Non-CPI Branded Hardware Products

All non-CPI branded products that are resold through CPI carry the original manufacturer's warranty, if any. All such warranty claims must be submitted directly to the original manufacturer in accordance with the terms of such warranty, if any.

For complete warranty information, visit chatsworth.com/warranty.

Returns and Repairs

No products or part thereof shall be returned to CPI unless the customer first obtains a Return Material Authorization (RMA) number from a CPI customer service representative. This number must appear clearly and prominently on all shipping containers. Containers without labels will not be accepted. The customer can choose to have the product sent back "as is" or scrapped by CPI.



Extended Limited Warranty CPI-Branded Hardware Products

Chatsworth Products (CPI) Extended limited warranties on CPI-Branded Electronic and Non-Electronic hardware products are available for two additional years beyond the expiration of the Original Warranty Period (3 years). CPI's Extended Limited Warranty can be purchased concurrently with, or separately from, the initial purchase of the product until the expiration of the Original Warranty Period for that product. To review CPI's Standard Limited Warranty, visit chatsworth.com/warranty. *CPI's standard limited warranty and extended limited warranty apply to CPI-branded hardware products only. Disclaimer of warranty: except as expressly set forth herein, CPI makes no other warranties, express or implied, including, without limitation, any warranties of fitness for a particular use or purpose, merchantability, or non-infringement of any intellectual property rights.*

CPI-Branded UPS Models featuring Lithium-Ion batteries carry a standard 6-year warranty with no further warranty extensions. CPI-branded UPS models featuring Lead-Acid batteries carry a standard warranty of 3 years. Customers are invited to extend the standard 3-year warranty to 5 years by adding an additional 2 years of coverage. Extended warranty includes coverage of electronics and internal batteries on UPS's and advanced replacement with ground shipping both ways.

Part Number	Type
2YEXTWAR-UPSVL1	Five-Year Warranty for VL800x - VL1500x Single-Phase UPS
2YEXTWAR-UPSVL2	Five-Year Warranty for VL2000x - VL3000x Single-Phase UPS
2YEXTWAR-UPSVL3	Five-Year Warranty for VL5000x Single-Phase UPS
2YEXTWAR-BP1	Five-Year Warranty for VXBP1 or VXBP2 Extended Runtime Battery Pack
2YEXTWAR-UPSVD1	Five-Year Warranty for VD2000x -VD3000x, Single-Phase UPS
2YEXTWAR-UPSVD2	Five-Year Warranty for VD2000x - VD3000x, Single-Phase UPS
2YEXTWAR-BP2	Five-Year Warranty for VXBP4, VXBP5, VXBP6, VXBP7 Extended Runtime Battery Pack
2YEXTWAR-UPSVD3	Five-Year Warranty for VD5000x, VD6000x, VD10Kx Single-Phase UPS
2YEXTWAR-BP3	Five-Year Warranty for VXBP8 or VXBP9 Extended Runtime Battery Pack
3YEXTWAR-UPSVD3PH1	Additional Three-Year Warranty for VD5K3P

CPI-Branded Electronic Products (Power, Monitoring & Security; PDUs [eConnect]*)

Part Number	Type	Manufacturer Suggested Retail Price of the Product Being Covered
L1-2YEXTWAR-ELECTRONICS-C	Electronic, Concurrent	Up to \$1700
L1-2YEXTWAR-ELECTRONICS-NC	Electronic, Non-Concurrent	Up to \$1700
L2-2YEXTWAR-ELECTRONICS-C	Electronic, Concurrent	\$1701 - \$3400
L2-2YEXTWAR-ELECTRONICS-NC	Electronic, Non-Concurrent	\$1701 - \$3400
L3-2YEXTWAR-ELECTRONICS-C	Electronic, Concurrent	\$3401 and above
L3-2YEXTWAR-ELECTRONICS-NC	Electronic, Non-Concurrent	\$3401 and above

**UPS's Excluded*

CPI-Branded Non-Electronic Products: (Cabinets & Containment; Racks & Cable Management; Cable Pathway Products; Bonding & Grounding; Wireless Enclosures

Part Number	Type	Manufacturer Suggested Retail Price of the Product Being Covered
L1-2YEXTWAR-OTHER-C	Non-Electronic, Concurrent	Up to \$1700
L1-2YEXTWAR-OTHER-NC	Non-Electronic, Non-Concurrent	Up to \$1700
L2-2YEXTWAR-OTHERS-C	Non-Electronic, Concurrent	\$1701 - \$3400
L2-2YEXTWAR-OTHERS-NC	Non-Electronic, Non-Concurrent	\$1701 - \$3400
L3-2YEXTWAR-OTHER-C	Non-Electronic, Concurrent	\$3401 and above
L3-2YEXTWAR-OTHER-NC	Non-Electronic, Non-Concurrent	\$3401 and above

Note: If the warranty needs to cover a CP or TS part number, which combines the CPI-Branded Electronic and Non-Electronic Hardware, then select warranty L3-2YEXTWAR-OTHER-NC.



ISO 9001 REGISTRATION

DQS Inc.
Chatsworth Products

<u>Operation</u>	<u>Certificate Registration No.</u>
Simi Valley, CA	10002325 QM15 Ref. 10002325
New Bern, NC	10002325 QM15 Ref. 10004453
Georgetown, TX	10002325 QM15 Ref. 10004454
Round Rock, TX	10002325 QM15 Ref. 10017461

Non-CPI Registration Marks

- Aruba® is a registered trademark of Hewlett Packard Enterprise Development LC.
- AutoCAD® is a registered trademark of Autodesk, Inc.
- Cisco® is a registered trademark of Cisco Systems, Inc.
- Slip-on® is a registered trademark of Slip-on Lock Nut Company Corporation.
- Visio® is a registered trademark of Microsoft Corporation.
- Power IQ® is a registered trademark of Sunbird.

All other trademarks belong to their respective companies.



The UL® Registered Firm symbol indicates that the facility has passed UL's evaluation to the international quality standards of the International Organization for Standardization. This means the facility has been

thoroughly monitored and has participated in an audit to determine compliance with a strict and comprehensive set of quality specifications. An appropriate quality system must be demonstrated to meet these specifications for quality in the relevant areas of design, development, production, assembly, final inspection and testing.



The UL Classified symbol indicates that Underwriters Laboratories Inc. classifies the product as an equipment bonding conductor only.



The UL Listed symbol indicates the product is Listed to applicable UL Standards and requirements by Underwriters Laboratories Inc.



The cULus symbol indicates compliance with both Canadian and U.S. requirements by Underwriters Laboratories Inc.



The UL Component Recognition symbol is used on components that are part of a larger product or system.



The CE Marking is a European marking of conformity, indicating a product complies with the requirements of the applicable European laws with respect to safety, health environment and consumer protection.



Environmentally Safe

CPI is committed to recycling as the solution to environmental and landfill concerns and continues to pursue packaging solutions that are cost effective and environmentally friendly.

CUSTOMER SERVICE & TECHNICAL SUPPORT

Based on your specific requirements, our Technical Support Specialists can help design the precise layout for your data center, and provide a detailed bill of material (BOM) complete with layout and assembly drawings. Furthermore, our Customer Service Representatives work closely with distributors to maintain product availability, ultimately helping preserve your project's scheduling requirements.

Contact Customer Service or Technical Support in the U.S & Canada at 800-834-4969, or outside the U.S. & Canada, at +818-739-3400 (Monday - Friday, 5 a.m. - 5 p.m., Pacific Time).

You can also chat with a Customer Service Representative using our website chat tool or email Technical Support at techsupport@chatsworth.com.

Design Tools

CPI provides a robust set of design tools at chatsworth.com to help you plan designs and solutions for most IT infrastructure needs.

These tools include:

- Building Information Modeling (BIM) Library
- Cable Fill Tables
- CAD Blocks
- CPI Product Designer
- eConnect® Secure Array® Cost Savings Estimator
- MasterFormat® Division 27 Specifications
- Power Selector
- Video Library
- Visio® Shapes

The CPI Mobile App Suite, chatsworth.com/en-us/mobile-apps, for both Apple and Google devices, is a collection of tools developed by CPI to help IT and telecommunications professionals determine cable fill, select server cabinets, identify the best power distribution unit (PDU), and create bills of material (BOM) for cable pathway, while on the go.

Quickly find a CPI distributor near you at chatsworth.com/en-us/how-to-buy/find-a-distributor.

CPI Product Designer

CPI Product Designer allows you to create enclosures quickly and easily by allowing you to select the size, features and accessories needed for a specific application. CPI Product Designer will generate bills of material, drawings, 3D models and sales documents automatically. Once the design is finished, you will receive a confirmation email with the product's description, part number, and bill of material with pricing and related documents. To access, go to chatsworth.com/en-us/resources/configurators-and-estimators/product-designer.



CPI Website

Visit chatsworth.com to use our design tools, estimators and configurators to determine the best solution for your business. You can locate, select and compare products on our website, add to a cart, then send to your local distributor for purchase. Use the website to find your nearest CPI Sales Manager, authorized distributor, or value-added reseller.

CPI Newsletter and Blog

Stay up to date with the latest news from CPI. Read our Cross-Connect blog at chatsworth.com/blog and take advantage of our monthly newsletter, "The Source" at chatsworth.com.

Buy American

Upon request, CPI is pleased to provide interested parties with a Certificate of Origin and Buy American Act and Buy America Act Compliance Certificate for all applicable part numbers. CPI Manufactured in America with globally sourced components.



SECTION 1

CABINETS & CONTAINMENT

ZetaFrame® Cabinet	1-3
ZetaFrame Cabinet Accessories	1-7
Z4-Series SeismicFrame® Cabinet	1-15
Z4-Series SeismicFrame Accessories	1-18
Aisle Containment Solutions	1-25
CUBE-iT® Wall-Mount Enclosure	1-33
ThinLine® II Wall-Mount Enclosure	1-41
Telecommunication Enclosures	1-43
Wire Cage Enclosure	1-50



*Learn about CPI's Standard Limited Warranty and Extended Limited Warranties.
See page vii for details.*

CABINETS & CONTAINMENT

CPI designs, manufactures and helps customers configure and customize the ideal cabinet platform—the foundation on which your enterprise is built and just as critical as the equipment it stores. Explore these options to determine which solutions best suit your needs.

Our Aisle Containment Solutions are flexible, feature-rich products for both hot and cold aisle containment that offer superior airflow management, resulting in reduced operating costs.

CPI offers a variety of open and enclosed wall-mount products for cables and equipment. Wall-mount systems create accessible locations for equipment where space is limited or does not exist. Store and secure equipment on the wall inside or outside of the data center or equipment room and connect remote groups of users to the network.

Where Can I Learn More?

To learn more about CPI's Cabinet & Containment Solutions, or to find additional part numbers not listed in this catalog, please visit our website, chatsworth.com.

Related Tools:

Use these tools, under the Resources tab on chatsworth.com, to simplify your planning, selection, order and purchase of CPI Cabinet & Containment Solutions.

- BIM Drawings
- Cable Fill
- CPI Product Designer
- CPI Power Selector
- eConnect® Secure Array® Savings Estimator

Featured Product:

ZetaFrame® Cabinet

- Customer-specified, factory-assembled solution reduces component count, packaging and on-site assembly, saving time and delivery cost
- Order a cabinet integrated with power, cable and thermal management preinstalled under a unique, project-specific part number
- Easy attachment and positioning of accessories allow for faster deployment and maintenance
- Optional shock pallet ensures safe delivery of racked ICT equipment



HCAI-OPM-0690

PATENTED

ZetaFrame® Cabinet System

A highly engineered data center cabinet solution that delivers fast built-to-order configurability, industry-leading strength and scalability, regardless of the application. ZetaFrame Cabinet is a total, turnkey solution that integrates with power, cable and thermal management accessories to support next-generation compute.

ZetaFrame Cabinet features:

Speedy Deployment. Customer-specified, factory-assembled solution reduces component count, packaging and on-site assembly, saving time and delivery cost.

Fast Selection and Customization. Order a cabinet integrated with power, cable and thermal management preinstalled under a unique, project-specific part number

Future-Proof Strength. Roll-formed, tubular and fully welded steel frame architecture supports 5,000 lb (2268 kg) static and 4,000 lb (1814 kg) dynamic loads.

Integrated Bonding. Doors and panels automatically bond to the frame through door hinges and contact points, eliminating the need for attaching separate grounding straps to cabinet components.

Enhanced Cable Management. Simple and versatile cable management accessories can be used independently or in combinations to accommodate a wide variety of applications.

Integrated Airflow Management. Seamless integration with optional airflow management accessories ensures effective conditioned/exhaust air separation and maximum equipment cooling.

Cabinet Specifications:

- Available in 4 heights, 4 widths and 5 depths
- Roll-formed, tubular and fully welded steel four-post frame
- For indoor use only, in environmentally controlled areas
- (2) pairs of square-punched mounting rails bolt to frame. Front-to-back adjustable depth
- 19"W, EIA-310 Universal 5/8"-5/8"-1/2" (15.9 mm – 15.9 mm – 12.7 mm) vertical hole spacing
- Shock Pallet option meets requirements per the International Safe Transit Association (ISTA) 2B
- Load capacity:
 - 5000 lb (2268 kg), static load on leveling feet per UL 2416
 - 4000 lb (1814 kg), rolling load on casters per UL 2416 for depths of 1000 mm or greater
 - 4000 lb (1814 kg), shipping load on shock pallet

Frame Includes:

- Integrated track at the top of the frame supports attachment of cable pathway and airflow containment accessories
- Equipment mounting rails, (2) pairs
- Leveling feet and load-bearing casters
- Floor attachment brackets
- Baying kit
- PDU bracket, (1) pair, for mounting (2) vertical CPI PDUs side-by-side in one corner of the cabinet
- Equipment mounting hardware, (50) M6 Klik-Nut® cage nuts and screws
- T25 Torx Bit to secure ground block and other accessories to cabinet frame

Certifications:

- EIA-310 compliant
- UL Listed 2416, NWIN, File #E227626

ZETAFRAME® CABINET SYSTEM

Use the part number configurator below to select a standard ZetaFrame Cabinet.

Choose the Height, Width, Depth, Panels, Thermal Configuration and Color. Example part number: **ZB45-A120A-E1**

Ships on Standard Pallet or Shock Pallet:

Z	1	2	3	-	4	5	6	7	8	-	9	10
---	---	---	---	---	---	---	---	---	---	---	---	----

1. Height			
U	in	mm	A
42	79.4	2017	A
45	84.6	2149	B
48	89.9	2283	C
52	96.9	2461	D

Height includes casters.

2. Width		
in	mm	1
23.6	600	1
27.6	700	2
29.5	750	3
31.5	800	4

3. Depth		
in	mm	1
31.5	800	1
39.4	1000	2
41.3	1050	3
43.3	1100	4
47.2	1200	5

Frame depth does not include doors. See detailed dimensions

4. Doors	
None	0
Single Perforated Front / Double Perforated Rear	A
No Front / Double Perforated Rear	B

10. Shipping	
1	Standard Pallet
2	Shock Pallet

Shock Pallet is available for 42U, 45U, 48U cabinet heights and 43.3"D (1100 mm) and 47.2"D (1200 mm) cabinet depths.cabinets.

9. Color	
7	Black
E	Glacier White

8. Thermal Management	
0	None
A	Air Dam
B	Air Dam, Brush-Sealed Front Rail

Brush-Sealed Front Rails are not available for 23.6"W (600 mm) cabinets.

7. Bottom Panel	
0	None
1	Grommet-Sealed
2	Brush-Sealed

6. Side Panel	
0	None
1	1 Side
2	2 Sides

5. Top Panel	
0	None
1	Grommet-Sealed
2	Brush-Sealed

Notes: All cabinets ship with two pairs of square-punched equipment mounting rails. Rails for 27.6"W (700 mm) and wider cabinets include four grommet-sealed cable openings (per rail). See detailed dimensions. Other sizes and configurations are available. Contact Technical support at techsupport@chatsworth.com for more information.



Configure It!

Take advantage of CPI's expertise and configure a complete solution, including eConnect® PDUs, RFID Electronic Locks and environmental sensors under a single part number. Custom solutions are also available through CPI's design engineering services. Email us at: techsupport@chatsworth.com

Use the part number configurator below to select a standard ZetaFrame Cabinet.

Choose the Height, Width, Depth, Panels, Thermal Configuration and Color. Example part number: **ZB45-DB22B-71**

Vertical Exhaust Duct Configuration for Front-to-Top Airflow:

Z	1	2	3	-	4	5	6	7	8	-	9	10																									
												10. Shipping																									
												1 Standard Pallet																									
1. Height												9. Color																									
<table border="1" style="width: 100%; border-collapse: collapse;"> <thead> <tr> <th>U</th> <th>in</th> <th>mm</th> <th>A</th> </tr> </thead> <tbody> <tr> <td>42</td> <td>79.4</td> <td>2017</td> <td>A</td> </tr> <tr> <td>45</td> <td>84.6</td> <td>2149</td> <td>B</td> </tr> <tr> <td>48</td> <td>89.9</td> <td>2283</td> <td>C</td> </tr> <tr> <td>52</td> <td>96.9</td> <td>2461</td> <td>D</td> </tr> </tbody> </table>												U	in	mm	A	42	79.4	2017	A	45	84.6	2149	B	48	89.9	2283	C	52	96.9	2461	D	<table border="1" style="width: 100%; border-collapse: collapse;"> <tbody> <tr> <td>7</td> <td>Black</td> </tr> <tr> <td>E</td> <td>Glacier White</td> </tr> </tbody> </table>		7	Black	E	Glacier White
U	in	mm	A																																		
42	79.4	2017	A																																		
45	84.6	2149	B																																		
48	89.9	2283	C																																		
52	96.9	2461	D																																		
7	Black																																				
E	Glacier White																																				
<i>Height includes casters.</i>												8. Thermal Management																									
												A Air Dam																									
												B Air Dam, Brush-Sealed Front Rail																									
												<i>Brush-Sealed Front Rails are not available for 23.6"W (600 mm) cabinets.</i>																									
2. Width												7. Bottom Panel																									
<table border="1" style="width: 100%; border-collapse: collapse;"> <thead> <tr> <th>in</th> <th>mm</th> <th>1</th> </tr> </thead> <tbody> <tr> <td>23.6</td> <td>600</td> <td>1</td> </tr> <tr> <td>27.6</td> <td>700</td> <td>2</td> </tr> <tr> <td>29.5</td> <td>750</td> <td>3</td> </tr> <tr> <td>31.5</td> <td>800</td> <td>4</td> </tr> </tbody> </table>												in	mm	1	23.6	600	1	27.6	700	2	29.5	750	3	31.5	800	4	<table border="1" style="width: 100%; border-collapse: collapse;"> <tbody> <tr> <td>0</td> <td>None</td> </tr> <tr> <td>1</td> <td>Grommet-Sealed</td> </tr> <tr> <td>2</td> <td>Brush-Sealed</td> </tr> </tbody> </table>		0	None	1	Grommet-Sealed	2	Brush-Sealed			
in	mm	1																																			
23.6	600	1																																			
27.6	700	2																																			
29.5	750	3																																			
31.5	800	4																																			
0	None																																				
1	Grommet-Sealed																																				
2	Brush-Sealed																																				
3. Depth												6. Side Panel																									
<table border="1" style="width: 100%; border-collapse: collapse;"> <thead> <tr> <th>in</th> <th>mm</th> <th>3</th> </tr> </thead> <tbody> <tr> <td>41.3</td> <td>1050</td> <td>3</td> </tr> <tr> <td>43.3</td> <td>1100</td> <td>4</td> </tr> <tr> <td>47.2</td> <td>1200</td> <td>5</td> </tr> </tbody> </table>												in	mm	3	41.3	1050	3	43.3	1100	4	47.2	1200	5	<table border="1" style="width: 100%; border-collapse: collapse;"> <tbody> <tr> <td>0</td> <td>None</td> </tr> <tr> <td>1</td> <td>1 Side</td> </tr> <tr> <td>2</td> <td>2 Sides</td> </tr> </tbody> </table>		0	None	1	1 Side	2	2 Sides						
in	mm	3																																			
41.3	1050	3																																			
43.3	1100	4																																			
47.2	1200	5																																			
0	None																																				
1	1 Side																																				
2	2 Sides																																				
<i>Frame depth does not include doors. See detailed dimensions</i>												<i>At least one side panel between adjacent cabinets and bottom panel are recommended for optimal thermal performance.</i>																									
4. Doors												5. Top Panel																									
Single Perforated Front / Single Solid Rear												A 15-20" H (381 - 508 mm) Vertical Exhaust Duct																									
												B 20-34" H (508 - 863 mm) Vertical Exhaust Duct																									
No Front / Single Solid Rear												C 34-60" H (863 - 1524 mm) Vertical Exhaust Duct																									
												D 15-20" H (381 - 508 mm) Vertical Exhaust Duct, Air Director																									
												E 20-34" H (508 - 863 mm) Vertical Exhaust Duct, Air Director																									
												F 34-60" H (863 - 1524 mm) Vertical Exhaust Duct, Air Director																									

A half brush seal is included at the lower rear of the duct.

Notes: All cabinets ship with two pairs of square-punched equipment mounting rails. Rails for 27.6"W (700 mm) and wider cabinets include four grommet-sealed cable openings (per rail). See detailed dimensions. Other sizes and configurations are available. Contact Technical support at techsupport@chatsworth.com for more information.



Configure It!

Take advantage of CPI's expertise and configure a complete solution, including eConnect® PDUs, RFID Electronic Locks and environmental sensors under a single part number. Custom solutions are also available through CPI's design engineering services. Email us at: techsupport@chatsworth.com

Dimension Tables:

Heights, Widths, Depths: See tables below for detailed dimensions.

Height Dimensions - in (mm)			
Rack Mount Spaces (U)	Overall with Casters	Frame Only No Casters	Front Opening
42	79.4 (2016)	77.4 (1965)	73.7 (1873)
45	84.6 (2149)	82.6 (2099)	79.0 (2006)
48	89.9 (2282)	87.9 (2232)	84.2 (2139)
52	96.9 (2460)	94.9 (2410)	91.2 (2317)

Casters add approximately 2" (51 mm) to frame and are factory-installed on the cabinet. Brush-sealed grommets in the top panel add approximately 3/8" (9 mm) to the height of the cabinet.

Depth Dimensions - in (mm)			
Nominal Depth	Overall with Doors	Frame Only No Doors	Maximum Rail Depth
31.5 (800)	34.6 (879)	31.5 (800)	28.5 (723)
39.4 (1000)	42.5 (1080)	39.4 (1000)	36.4 (923)
41.3 (1050)	44.4 (1128)	41.3 (1050)	38.3 (973)
43.3 (1100)	46.4 (1179)	43.3 (1100)	40.3 (1023)
47.2 (1200)	50.3 (1278)	47.2 (1200)	44.2 (1123)

Front Door is approximately 1.6"D (41 mm) and Rear Door is approximately 1.5"D (38 mm). Minimum rail depth is 7" (178 mm), each rail is 3.5"D (89 mm). Rail depth is reduced when vertical accessories are placed in corners.

Width Dimensions - in (mm)			
Nominal Depth	Overall with Side Panels	Front Opening	Rack-Mount Panel Width
23.6 (600)	23.6 (600)	19.9 (506)	19 (482.6)
27.6 (700)	27.6 (700)	23.9 (607)	19 (482.6)
29.5 (750)	29.5 (750)	25.8 (655)	19 (482.6)
31.5 (800)	31.5 (800)	27.8 (707)	19 (482.6)

Mounting Rail clearance is 17.8" (452 mm), mounting hole spacing is 18.3" (465 mm).

Installation Products

Part Number	Description	Shipping Weight lb (kg)
39150-001	Leveling Feet Height Adjustment Tool, 5 mm Hex Ball Driver, 12"L (300 mm)	1 (0.5)
39207-701	Ramp Kit for Shock Pallet Cabinets, Black	26 (11.8)
76543-001*	Clik-Nut Hardware Kit, Cage Nuts, Screws, M6, 25 Pack, Zinc	1 (0.5)

Note: Baying Kits and Floor Mounting Brackets are included with each cabinet.

**Additional thread size and quantities available.*



Leveling Feet Height Adjustment Tool



Clik-Nut Hardware Kit



Ramp Kit for Shock Pallet Cabinets.



Side Panels

- Available in Solid or with Grommets
- Includes: Side panel (two halves, solid or with grommets), set of keys
- Two-piece design with top and bottom halves for easier handling
- Tool-less removal, drop-in design with integrated locking spring latch secures the side panel to the cabinet frame
- Features integral bonding, no bonding strap required
- Side Panel with Grommets feature multiple grommet-sealed cable openings, allowing cables to enter the side of the cabinet while containing exhaust air within each cabinet
- Side Panel with Grommets feature (8) cable openings per side, (4) per half-height panel, (1) per corner; Cable opening size without grommet is 4.5"W x 9"D (114 mm x 228 mm), sized for large power plugs
- Grommets are plastic, snap-on and can be cut to pass cables

		Part Number				Cabinet Frame Depth in (mm)	Shipping Weight lb (kg)
Solid	Grommet	Height (U)					
		42	45	48	52		
39763	39774	-X00	-X51	-XAC	-XDL	31.5 (800)	34 (15.5)
		-X08	-X59	-XAL	-XDW	39.4 (1000)	41 (18.6)
		-X10	-X61	-XAN	-XEA	41.3 (1050)	43 (19.1)
		-X12	-X63	-XAR	-XEC	43.3 (1100)	45 (20.2)
		-X16	-X67	-XAW	-XEG	47.2 (1200)	48 (21.7)

Note: X=color: 7=Black, E=Glacier White. Shipping weights are for 52U configurations



Air Dam Kit

Air Dam blocks airflow around the sides and top of the equipment mounting space, so conditioned air passes through equipment and exhaust air does not recirculate around equipment. Configure with cabinet or available separately as an accessory.

- Use with Equipment Mounting Rail Grommet Brush Kit and Bottom Panel
- Includes: Top, bottom and side baffles; installation hardware
- 600 mm attaches by wrapping around flange, 700, 750 & 800 mm attaches by snapping onto half lance
- Requires a minimum rail setback of 1.4" (36 mm) from the front of the cabinet frame; maximum rail setback is 13.7" (348 mm)
- Flexible seal against top and side panels
- Select part number to match the frame style, width, usable height and color
- Material: Steel, sheet metal, plastic seals
- Finish: Black or Glacier White; seals are black

Part Number - Cabinet Width				Height (U)	Shipping Weight lb (kg)
23.6"W (600 mm)	27.6"W (700 mm)	29.5"W (750 mm)	31.5"W (800 mm)		
38649-X44	38649-X55	38649-X77	38649-X66	42	11 (5.0)
38649-X47	38649-X58	38649-X80	38649-X69	45	11 (5.0)
38649-X50	38649-X61	38649-X83	38649-X72	48	11 (5.0)
38649-X54	38649-X65	38649-X87	38649-X76	52	12 (5.1)

Note: X=color: 7=Black, E=Glacier White. Shipping weights are for 800 mm configurations



39731-XXX

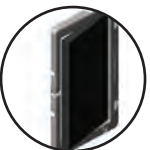

39716-XXX

Equipment Mounting Rail Grommet Kit

Set of (8) flexible plastic grommets that cover cable openings in the equipment mounting rails to block airflow around equipment. Configure with cabinet or available separately as an accessory.

- Grommets are plastic. Trim as needed to form seal around cables
- Not compatible with 23.6" W (600 mm) cabinet
- UL 94-V0 flammability rating

Equipment Mounting Rail Brush Kit

Set of (8) brush covers that conceal cable openings in the equipment mounting rails to block airflow around equipment. Configure with cabinet or available separately as an accessory.

- Allows for quick cable installation through mounting rails while maintaining a seal
- Suited for high cable density applications
- Split bezel design does not capture cables and allows for retrofitting around existing cables
- Not compatible with 23.6" W (600 mm) cabinets, UL 94-V0 flammability rating
- Material: Plastic housing, nylon brushes

Part Number	Description	Shipping Weight lb (kg)
39731-001	Grommet Kit, for 27.6"W (700 mm) and 29.5"W (750 mm) Cabinets; Pack of 8; Black	2 (0.9)
39731-002	Grommet Kit, for 31.5"W (800 mm) Cabinet; Pack of 8; Black	2 (0.9)
39716-001	Brush Kit, for 27.6"W (700 mm) and 29.5"W (750 mm) Cabinets; Pack of 8; Black	2 (0.9)
39716-002	Brush Kit, for 31.5"W (800 mm) Cabinet; Pack of 8; Black	3 (1.4)



Seal Kit Installation

Cabinet To Floor Seal Kits

Place at the bottom of cabinets to seal the space between the bottom of the cabinet and the floor when leveling feet or casters are in use. Ideal for aisle containment applications.

Part Number	Description	Shipping Weight lb (kg)
Floor Seal Kit, Front and Rear		
39996-X00	For 23.6"W (600 mm) Cabinet	4.0 (1.8)
39996-X01	For 27.6"W (700 mm) Cabinet	4.2 (1.9)
39996-X02	For 29.5"W (750 mm) Cabinet	4.3 (2.0)
39996-X03	For 31.5"W (800 mm) Cabinet	4.4 (2.0)
Floor Seal Kit, Sides		
39997-X00	For 31.5"D (800 mm) Cabinet	4.4 (2.0)
39997-X08	For 39.4"D (1000 mm) Cabinet	5.8 (2.6)
39997-X10	For 41.3"D (1050 mm) Cabinet	6.3 (2.9)
39997-X12	For 43.3"D (1100 mm) Cabinet	6.9 (3.1)
39997-X16	For 47.2"D (1200 mm) Cabinet	7.9 (3.6)

Note: X=Color: 7=Black, E=Glacier White.



Cable Port Brush Kits

- Use to replace grommets in top, bottom, or side panels
- Cable opening is 3.9"W x 8.8"D (99 mm x 224 mm)
- Configure with cabinet or available separately as an accessory.

Part Number	Description	Shipping Weight lb (kg)
25190-001	Cable Port Brush Kit, Pack of 2, Black	2 (0.9)



Snap-In Filler Panel

Snap-In Filler Panel blocks airflow in between equipment by sealing unused rack-mount spaces (U) in the cabinet. Use with Air Dam Kit and Bottom Panel to separate cold and hot air within the cabinet.

Part Number	Description	Shipping Weight lb (kg)
34537-X00	Snap-In Filler Panel, 1U x 19"W (482.6 mm), Single	14 (6.4)
34537-X01	Snap-In Filler Panel, 1U x 19"W (482.6 mm), 6 Pack	14 (6.4)
34538-X00	Snap-In Filler Panel , 2U x 19"W (482.6 mm), Single	21 (9.5)
34538-X01	Snap-In Filler Panel , 2U x 19"W (482.6 mm), 6 Pack	21 (9.5)

Note: X=Color: 0=Black, E=Glacier White.



Raised Floor Grommets

Raised Floor Grommets provide a reliable seal around cable bundles. Split design allows for retrofitting over existing cable bundles in access floor tiles.

Part Number	Description	Shipping Weight lb (kg)
13671-001	Floor Grommet, with Hardware, Single, Black	2 (1.4)
13671-002	Floor Grommet, with Hardware, 10 Pack, Black	18 (8.2)

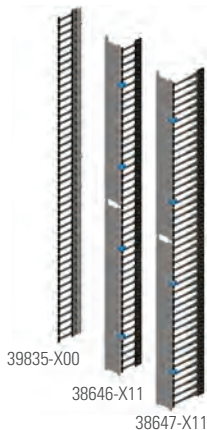

Vertical Cable Manager

- Fully compatible with Air Dam Kit and Cable Lashing Panel
- Openings between fingers align with each U on the mounting rail
- Short or long plastic T-shaped finger options
- Rail setback:
 - 7-1/4" (184 mm) for Managers with long fingers
 - 4-3/4" (121 mm) for Managers with short fingers
- Long fingers pass up to (48) cables per U space through openings
- Short fingers pass up to (24) cables per U space through openings
- Hinged cover included with managers in cabinets wider than 600 mm
- Material: aluminum panels, fingers are black, hinges/latches are blue
- Finish: Black or Glacier White; fingers and latches are plastic
- Select part number to match cabinet usable height, width and color cabinet

Part Number - Cabinet Width				Height (U)	Shipping Weight lb (kg)
23.6"W (600 mm)	27.6"W (700 mm)	29.5"W (750 mm)	31.5"W (800 mm)		
Vertical Cable Manager with Long Fingers					
N/A	38647-X11	38647-X22	38647-X33	42	9 (4.1)
N/A	38647-X14	38647-X25	38647-X36	45	10 (4.5)
N/A	38647-X17	38647-X28	38647-X39	48	10 (4.5)
N/A	38647-X21	38647-X32	38647-X43	52	10 (4.5)
Vertical Cable Manager with Short Fingers					
39835-X00	38646-X11	38646-X22	38646-X33	42	9 (4.1)
39835-X03	38646-X14	38646-X25	38646-X36	45	10 (4.5)
39835-X06	38646-X17	38646-X28	38646-X39	48	10 (4.5)
39835-X10	38646-X21	38646-X32	38646-X43	52	10 (4.5)

Note: X=Color: 7=Black, E=Glacier White. Shipping weights are for 800 mm configurations

Inside Dimensions, Usable Internal Area, Rail Setback, U Opening					
Cabinet Width	Width in (mm)	Depth in (mm)	Cable Area in ² (mm ²)	Rail Setback in (mm)	U Opening in ² (mm ²)
Vertical Cable Manager with Long Fingers					
27.6 (700)	2.2 (56)	7.5 (191)	17.0 (10 967)	10.1 (257)	6.6 (460)
29.5 (750)	3.2 (81)	7.5 (191)	24.5 (15 806)	10.1 (257)	6.6 (460)
31.5 (800)	4.2 (107)	7.5 (191)	31.9 (20 580)	10.1 (257)	6.6 (460)
Vertical Cable Manager with Short Fingers					
23.6 (600)	0.4 (10)	5 (127)	1.8 (1161)	7.6 (193)	3.5 (2260)
27.6 (700)	2.2 (56)	5 (127)	11.2 (7225)	7.6 (193)	3.5 (2260)
29.5 (750)	3.2 (81)	5 (127)	16.2 (10 451)	7.6 (193)	3.5 (2260)
31.5 (800)	4.2 (107)	5 (127)	21.2 (13 677)	7.6 (193)	3.5 (2260)

Rail setback is the minimum distance required between the front edge of the cabinet frame and the front edge of the equipment mounting rail. U opening is the size of the side opening at each U space between T-shaped fingers.



38634

38635

38636



Cable Bundle Swivel, installed

Cable Lashing Panel

- Creates simple, vertical pathways for small cable bundles
- Attaches to cabinet frame, adjusts in depth independent of the mounting rails; Can be installed adjacent to Vertical Cable Manager
- Includes: Brackets, Cable Bundle Swivels and installation hardware
- Available in 3 widths: 2-3/4 "W (70 mm), 4.5"W (115 mm) and 7"W (178 mm)
- 2-3/4"W (70 mm) includes (6) Cable Bundle Swivels, 4.5"W (115 mm) and 7"W (178 mm) include (12) Cable Bundle Swivels
- Patented Cable Bundle Swivels provide quick attachment, removal and adjustment of cable bundles
- Select part number per cabinet height and color
- Material: Steel; Cable Bundle Swivels are plastic
- Finish: Black or Glacier White; Cable Bundle Swivels are blue

Part Number - Panel Width			Height (U)	Shipping Weight lb (kg)
2-3/4 (70 mm)	4.5"W (115 mm)	7.0"W (178 mm)		
38634-X00	38635-X00	38636-X00	42	13 (5.9)
38634-X03	38635-X03	38636-X03	45	14 (6.4)
38634-X06	38635-X06	38636-X06	48	15 (6.8)
38634-X10	38635-X10	38636-X10	52	16 (7.3)
32657-001	Cable Bundle Swivel, Pack of 12			1 (0.5)

Note: X=Color: 7=Black, E=Glacier White. Shipping weights are for 7"W (178 mm) Lashing Panels.



Front-to-Rear Cable Manager

Front-to-Rear Cable Manager attaches to the back of equipment mounting rails wherever there are cable openings, creating a cable pathway between front and rear rails.

- Hooks into front and rear mounting rails, and secures to cabinet frame using supplied hardware
- Adjustable to match various front-to-rear rail depths ranging from 20" (508 mm) to 32" (812 mm)
- Sold each, order to match cabinet width and color
- Material: Steel
- Finish: Black or Glacier White

Part Number - Cabinet Width				Rail Depth Range	Shipping Weight lb (kg)
23.6"W (600 mm)	27.6"W (700 mm)	29.5"W (750 mm)	31.5"W (800 mm)		
N/A	38648-X01	38648-X02	38648-X03	20-32 (508 - 812)	7 (3.2)

Note: X=Color: 7=Black, E=Glacier White. Shipping weight is for 800 mm configuration



Full Height PDU Bracket

- Available in Single or Dual options
- Order per PDU chassis width and PDU bracket capacity (1 or 2 PDUs)
- Bracket attaches to cabinet frame and is adjustable along the cabinet depth
- Use Dual bracket to mount (2) PDUs side-by-side or (1) PDU high outlet density 4" (102 mm) PDU chassis
- Tool-less mounting features at 12-1/4" increments up to 61-1/4" and 64-3/4"

Part Number - PDU Chassis Width			Cabinet Height (U)	PDU Bracket Capacity
2.2" (56 mm)	2.4-2.7" (51 - 69 mm)	4.0" (102 mm)		
38637-X00	38637-X11	38638-X00	42	Single
38637-X03	38637-X14	38638-X03	45	Single
38637-X06	38637-X17	38638-X06	48	Single
38637-X10	38637-X21	38638-X10	52	Single
38638-X00	38638-X11	N/A	42	Double
38638-X03	38638-X14	N/A	45	Double
38638-X06	38638-X17	N/A	48	Double
38638-X10	38638-X21	N/A	52	Double

Note: X=Color: 7=Black, E=Glacier White. Shipping weights are for Dual PDU Brackets



Standard PDU Bracket

- Includes (1) pair of brackets and installation hardware for use with CPI eConnect PDUs or vertical Power Strips.
- Supports (2) 2.7"W (69 mm) or narrower PDUs side-by-side or one PDU up to 4"W (101.6 mm)
- Attaches to the frame in either back corner
- Provides tool-less attachment points spaced 61-1/4" (1556 mm) apart on all cabinets
- Provides alternate tool-less attachment points spaced 64-3/4" (1645 mm) on cabinets 45U or taller

Part Number	Description	Shipping Weight lb (kg)
38645-700	2-Piece, Black	2 (0.9)



Simplify ordering, shipping and installation by requesting eConnect PDUs and eConnect RFID Electronic Lock Kit to be installed in CPI's cabinets before they leave the factory. Request Redundancy Pack for easy identification of primary and secondary units.

Add power. Make it easy.

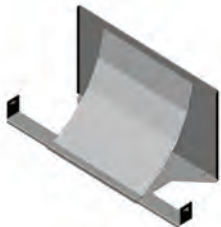

Air Director

Air Director is an angled panel used at the back of cabinets for higher heat load applications with Vertical Exhaust Duct top panels to guide exhaust air toward the top of the cabinet.

- Attaches to the bottom slide on the cabinet, adjusts in depth
- Select part number to match width and color of the cabinet
- Material: Steel; Finish: Black or Glacier White

Part Number	Description	Shipping Weight lb (kg)
39802-X00	For 23.6"W (600 mm) Cabinets	12 (5.2)
39802-X01	For 27.6"W (700 mm) Cabinets	13 (5.9)
39802-X02	For 29.5"W (750 mm) Cabinets	14 (6.2)
39802-X03	For 31.5"W (800 mm) Cabinets	15 (6.5)

Note: X=Color: 7=Black, E=Glacier White.



eConnect RFID Electronic Lock Kit

eConnect RFID Electronic Lock Kit is a front and rear single-factor, 12V lock solution that is activated by RFID cards and fully integrates into networked eConnect power distribution units PDUs (P/N EX-XXXX only), so that no additional appliance or external software are required. Available on vertical Monitored, Monitored Pro, Switched and Switched Pro PDUs.

Kit includes:

- 12 Volt locks
- Front and rear swing handles
- 3 door sensors (front and rear doors)
- 2 wiring harnesses (for front and rear connection)
- 2 mechanical override keys

Part Number	Description	Shipping Weight lb (kg)
14666-001	eConnect® RFID Electronic Lock Kit	3 (1.4)
14665-001	USB Temperature and Humidity Sensor	1 (0.5)
36651-001	Wire Harness Kit	1 (0.5)
36652-001	Door Sensor Kit	1 (0.5)
36653-001	RF IDEAS EAC Smart Card Reader	1 (0.5)
36654-001	RFID Cards, Pack of 20	1 (0.5)

Cabinet Accessories

Bay Seal Kit

Bay Seal Kit is only used with 23.6" W (600 mm) cabinets when the cabinets are bayed to align with 24" W (610 mm) floor tiles. The bay seal kit fills the small gaps left between cabinets.

- Flexible plastic insert that blocks airflow between cabinets
- Includes: side baffles, cut to length
- Material: Plastic; Finish: Black only

39137-XXX

Seal Kit

Cover unused holes in the frame to prevent bypass airflow.

- Pre-cut, plastic, color-matched, adhesive backed labels for easy attachment
- Tough, heat resistant material and adhesive for long life
- Each kit includes 12 sheets; 21 round labels and six rectangular labels
- Round labels are .75" (19 mm) diameter. Rectangular labels are 1.3" x 2.2" (34 mm x 55 mm).
- Material: Thermoplastic polycarbonate film
- Select to match the color of the cabinet

39076-X00

Ramp Kit for Shock Pallet Cabinets

Ramp Kit includes a pair of steel ramps used to roll a loaded cabinet off of a shock pallet.

- Durable, welded steel construction for repeated use
- 0.7" H (17.4 mm) sides control casters to prevent the cabinet from rolling off ramp
- Gradual, 4.5'L (1.4 m) incline for controlled exit
- Includes: one pair of steel, black finish ramps
- Order one Ramp Kit per site for Shock Pallet Cabinets

Leveling Feet Height Adjustment Tool

- Used in drill/driver to adjust the height of leveling feet.
- 5 mm Hex Ball Driver Tool; 12" L (300 mm)

39207-701

39150-001

Part Number	Description	Shipping Weight lb (kg)
39137-700	Bay Seal Kit, For 42U	5 (2.3)
39137-703	Bay Seal Kit, For 45U	5 (2.3)
39137-706	Bay Seal Kit, For 48U	5 (2.3)
39137-710	Bay Seal Kit, For 52U	5 (2.3)
39076-X00*	Seal Kit, Pack of 12	1 (0.5)
39207-701	Ramp Kit for Shock Pallet Cabinets, Black	26 (11.8)
39150-001	Adjustment Tool, Hex Ball Driver	1 (0.5)

*X=color: C=Black, E=Glacier White.



HCAI-OPM-0112

HCAI-OPM-0112 provides pre-approved, code-compliant seismic designs of supports and attachments for the cabinet when used in health facilities in California.

Load-Tested GR-63, Zone 4

Z4-Series SeismicFrame® Cabinet System

The Z4-Series SeismicFrame Cabinet System is an engineered solution specifically designed to store critical rack-mount server, data storage and network equipment in computer rooms, equipment rooms and other communications facilities that are located in active seismic areas.

Featuring an industry-leading 1500 lb (680 kg) equipment load, the Z4-Series SeismicFrame can also support an additional 100 lb (45 kg) top load for cabling. This cabinet was tested by a Telecommunications Carrier Group and ISO 17025 certified Independent Testing Laboratory (ITL) to meet the Telcordia Technologies GR-63-CORE, Issue 4, April 2012, Sections 4.4 per Zone 4 requirements. GR-63-CORE seismic testing includes a series of physical shaker table tests, during which a loaded cabinet is placed through simulated earthquake conditions. Zone 4 testing includes the most severe test conditions, in which the cabinet must perform with limited movement and survive the test without permanent structural or mechanical damage, ensuring the internal equipment is not damaged.

The cabinet is available with optional solid top panel, solid side panels and perforated doors. Top panel has four cable ports (one per corner). The side panels bolt on, and include locks. The front door is a single door with single point latch. The rear door is double (vertically split) with a three-point latch. Combine the Z4-Series SeismicFrame Cabinet with thermal and cable management accessories to create a solution that fits your exact needs.

Cabinet Specifications:

- Available in 2 heights, 2 widths, 2 depths
- Provides front and rear support for 19"W (482.6 mm) EIA rack-mount equipment and shelves
- Adjustable depth, rails slide front-to-back
- Marks on frame for easy vertical alignment
- 1-3/4"H (44.45 mm) U spacing, marked and numbered
- 19"W, EIA-310 Universal vertical hole spacing
- Seismic Load: 1500 lb (680 kg) internal seismic equipment load
100 lb (45 kg) additional cabinet roof load
- Static Load: 3000 lb (1360 kg) per UL2416

Cabinet Includes:

- Welded and bolted steel four-post frame
- Equipment mounting rails, two pairs
- Grounding/bonding system and ground lug
- Recessed leveling feet
- Removable transport casters
- Baying kit
- Equipment mounting hardware, (50) M6 cage nuts and screws

Certifications:

- EIA-310 compliant
- UL Listed 2416, NWIN, File #E227626
- TCG NEBS Compliant, Telcordia Technologies, GR-63-CORE, Issue 4, April 2012, Sections 4.4, per Zone 4 requirements
- OSHPD OPM-0112-13 California, Office of Statewide Health Planning and Development (OSHPD), Preapproval of Manufacturer's Certification (OPM)

Z4-SERIES SEISMICFRAME® CABINET SYSTEM

Z4-Series SeismicFrame Cabinet is available in three basic configurations: a full cabinet with or without side panels, a cabinet with no doors with or without side panels or a frame only with no doors or panel work. Use the part number configurators below to select a Z4-Series SeismicFrame Cabinet. Choose Height, Width, Depth, Front Door, Locks and Sides based on your requirements.

Example Cabinet Part Number: Z4-12U-113C-C12.

Z4-Series SeismicFrame Cabinets - Frame with Top Panels and Doors, Side Panels are optional.

Z4	-	H	W	D	-	R	FD	RD	L	-	C	TP	SP		
Height			Rails			Side Panels									
U	in	mm			Square-Punched	1				0	None				
40	78.7	1999	1							2	Solid, 2 Each				
43	83.9	2132	2												
Width			Front Doors			Top Panel									
in	mm				None	0				1	Standard				
23.6	600	1				Single, Perf.	1								
31.5	800	2													
Depth			Rear Doors			Color									
in	mm				Double, Perforated	3				C	Black				
41.3	1050	N							E	Glacier White					
47.3	1200	U													
			Latches												
			2-Point, Keyed			C									
			2-Point, Keyed Combination			E									



Z4-12U-113C-C12 shown

Z4-Series SeismicFrame Cabinets – Frame with Top Panel, no Doors, Side Panels are optional.

Z4	-	H	W	D	-	R	FD	RD	L	-	C	TP	SP		
Height			Rails			Side Panels									
U	in	mm			Square-Punched	1				0	None				
40	78.7	1999	1							2	Solid, 2 Each				
43	83.9	2132	2												
Width			Front Doors			Top Panel									
in	mm				None	0				1	Standard				
23.6	600	1													
31.5	800	2													
Depth			Rear Door			Color									
in	mm				None	0				C	Black				
41.3	1050	N							E	Glacier White					
47.3	1200	U													
			Latches												
			None			0									



Z4-12U-1000-C10 shown

Z4-Series SeismicFrame Cabinets – Frame Only, No Top Panel, No Doors, or Side Panels.

Z4	-	H	W	D	-	R	FD	RD	L	-	C	TP	SP
----	---	---	---	---	---	---	----	----	---	---	---	----	----

Height		
U	in	mm
40	78.7	1999
43	83.9	2132

Width		
in	mm	
23.6	600	1
31.5	800	2

Depth		
in	mm	
41.3	1050	N
47.3	1200	U

Rails	
Square-Punched	1

Front Doors	
None	0

Rear Door	
None	0

Latches	
None	0

Side Panels	
0	None

Top Panel	
0	None

Color	
C	Black
E	Glacier White



Specifications/Ordering Notes:

- There are eight possible frame sizes.
- Use the first matrix to order a complete cabinet with top, doors and sides; use the second matrix to order a cabinet with no doors; use the last matrix to order a Frame Only with no top, doors or sides.
- You must include a top panel when ordering a cabinet with doors.
- You can order a cabinet with or without side panels.
- You can order a cabinet with or without a front door.
- Choose latch/lock style: keyed or combination/keyed. Every door must have a latch. The (0) option should only be selected if there are no doors. Doors have a swing handle on the exterior. The combination lock uses a 3-digit combination entered on three-dials that are integrated into the swing handle or a key. The combination lock can be reprogrammed in the field.
- The front door has a single-point latch; the rear door has a two-point latch.
- Heights, Widths, Depths: see tables below for detailed dimensions.

Height Dimensions - in (mm)			
Rack Mount Spaces (U)	Overall with Casters	Frame Only No Casters	Front Opening
40	78.7 (1999)	77.4 (1965)	70.4 (1789)
43	83.9 (2132)	82.6 (2099)	75.7 (1922)

Casters are factory-installed on the cabinet, used to move the cabinet into position and then removed before installation. The cabinet frame attaches directly to the floor.

Depth Dimensions - in (mm)			
Nominal Depth	Overall with Doors	Frame Only No Doors	Maximum Rail Depth
1050	45.1 (1146)	41.3 (1050)	35.8 (911)
1200	51.1 (1296)	47.2 (1200)	41.7 (1061)

Front Door is approximately 2.2"D (56 mm), and Rear Door is approximately 1.7"D (43 mm) with hinges/latches. Minimum rail depth is 10.2" (258 mm). The front rail is 6.7" (170 mm) deep; the rear rail is 3.5" (89 mm) deep. Rail Depth is reduced when vertical accessories are placed in corners.

Width Dimensions - in (mm)			
Nominal Depth	Overall with Side Panels	Front Opening	Rack-Mount Panel Width
600	23.6 (600)	19.6 (498)	19 (482.6)
800	31.5 (800)	27.5 (698)	19 (482.6)

Mounting Rail clearance is 17.8" (452 mm), mounting hole spacing is 18.3" (465 mm).



Air Dam Kit

Air Dam blocks airflow around the sides and top of the equipment mounting space, so cold air passes through equipment, and hot air does not recirculate around equipment.

- Use with Snap-In Filler Panels and Equipment Rail Grommet Kit
- Attaches to and adjusts with mounting rails
- Requires a minimum rail setback of 2.3" (58 mm) from the front of the frame
- Flexible seal against top and side panels
- Includes: top, bottom and side baffles; installation hardware
- Material: Steel baffles, plastic seals
- Select part number to match the width, usable height and color of the cabinet

Part Number 23.6"W (600 mm)	Part Number 31.5"W (800 mm)	Height (U)	Shipping Weight lb (kg)
14435-X00	14435-X02	40	14 (6.4)
14435-X01	14435-X03	43	15 (6.8)

X=Color, C=Black, E=Glacier White. Shipping Weights are for 800 mm kits.



Cable Lashing Bracket

Cable Lashing Bracket creates a simple, separate vertical pathway for a small bundle of cables and has multiple slots for CPI Saf-T-Grip® Straps or tie wraps to secure cables to the bracket.

- Attaches to the frame in a fixed location, independent of the equipment rails
- Use multiple to increase capacity
- Bracket is 1.6"W (41 mm)
- Includes: brackets, installation hardware; order Saf-T-Grips or cable ties separately
- Material: Steel

Part Number	Height (U)	Shipping Weight lb (kg)
14465-X00	40	3 (1.4)
14465-X01	43	3 (1.4)

X=Color, C=Black, E=Glacier White.



Front-To-Rear Cable Manager

Front-to-Rear Cable Manager attaches to the back of equipment mounting rails, creating a front-to-rear pathway between the front and rear mounting rails for cables.

- For use on 31.5"W (800 mm) cabinets
- Mounting locations behind cable openings on each rail
- Attaches to mounting rails and extends from 17.5" (445 mm) to 30.5" (775 mm) to match rail depth
- Creates a 3.0"H (76 mm) by 2.5"W (64 mm) front-to-rear pathway for cables
- Includes: cable manager, installation hardware
- Material: Steel panels

Part Number 23.6"W (600 mm)	Part Number 31.5"W (800 mm)	Height (U)	Shipping Weight lb (kg)
N/A	14485-X00	17.5 - 30.5 (445 - 775)	6 (2.7)

X=Color, C=Black, E=Glacier White.



Ring Cable Manager

Ring Cable Manager is independent of the equipment mounting rails, creating a separate vertical pathway for cables and includes plastic cable rings to organize cables.

- Attaches to the frame in a fixed location, independent of the equipment mounting rails
- Rings have an opening on the front for easy addition or removal of cables
- Includes: brackets, rings, installation hardware
- Material: Steel brackets, plastic rings
- Select part number to match the width, usable height and color of the cabinet

Part Number 23.6"W (600 mm)	Part Number 31.5"W (800 mm)	Height (U)	Shipping Weight lb (kg)
14440-X00	14445-X00	40	13 (5.9)
14440-X01	14445-X01	43	13 (5.9)

X=color; C=Black, E=Glacier White. Shipping Weights are for 800 mm managers.

Inside Dimensions, Usable Internal Cable Area, Rails Setback				
Cabinet Width	Width in (mm)	Depth in (mm)	Cable Area in ² (mm ²)	Rail Setback in (mm)
23.6 (600)	.9 (29)	3.3 (84)	2.9 (1870)	9.5 (240)
31.5 (800)	4.2 (107)	3.5 (89)	14.7 (9480)	9.7 (246)



Full Height PDU Bracket, Dual and Wide

Full Height Dual PDU Bracket supports two vertical PDUs side-by-side and has multiple slots for CPI Saf-T-Grip Straps or tie wraps to secure cords to the bracket. Available in two widths: Dual and Wide

- Attaches to the frame in a fixed location, independent of the equipment mounting rails
- Dual bracket is 4.8"W (121 mm) and supports (2) PDUs up to 2.2"W (56 mm) side-by-side
- Wide bracket is 5.8"W (147 mm) and supports (2) PDUs up to 2.7"W (69 mm) side-by-side
- Wide bracket is required to mount (2) 6-breaker eConnect PDUs will only fit in the 43U cabinet.
- Tool-less mounting on 28" (711 mm), 61.25" (1556 mm) or 64.75" (1645 mm) centers
- Includes: brackets, installation hardware; order Saf-T-Grips or cable ties separately
- Material: Steel
- Select part number to match PDU size, usable height and color of the cabinet

Part Number Dual	Part Number Wide	Height (U)	Shipping Weight lb (kg)
14480-X00	14481-X00	40	12 (5.4)
14480-X01	14481-X01	43	11 (5.0)

X=color; C=Black, E=Glacier White. Shipping weights are for Wide managers. eConnect PDUs, will not fit inside a 40U cabinet.



Raised Floor Grommet

Reduce bypass airflow and improve data center cooling efficiency with CPI's Raised Floor Grommets. Achieve an effective seal around cables with the dual-layer brush design with integrated membrane layer.

- Split design allows easy addition around existing cables. Add cable openings to the edge of floor tiles for easy addition or removal of cables
- Rectangular Raised Floor Grommet features EPDM membrane between two layers of nylon brushes that forms a superior seal around cable bundles
- Durable sealing materials will not break, tear or deform from repeated use
- Available as singles or in carton of 10
- Black Finish

Part Number		Description	Shipping Weight lb (kg)
Each (1)	Pack (10)		
Deluxe Filter Cabinet Ventilation System			
13671-001	13671-002	Raised Floor Grommet, 1-5/8" (41 mm) x 11" (279 mm) x 8-1/4 (210 mm) Overall Size; 9-1/4"W (235 mm) x 6-3/4"D (172 mm) required hole in floor	18 (8.2)

Shipping Weights are for 10 pack.



Drawer with two-post mounting brackets



Drawer with four-post mounting brackets

Lockable Storage Drawer

Drawer stores backup media, software, manuals, laptops, test equipment and extra patch cords in close proximity to the cabinet and is now stackable. Drawers are available for 19"W or 23"W racks and cabinets, and include attachment brackets that allow center mounting on two-post racks with 3" or 6"D (80 mm or 150 mm) equipment channels or front and rear attachment to four-post racks and cabinet systems (mounting rails must be adjusted between 24" and 39" (610 mm and 990 mm) in depth).

- Attaches to any CPI freestanding 19"W or 23"W rack or cabinet system
- Features 20"D (510 mm) lockable drawer that extends full depth for easy access to stored equipment
- Supports a 100 lb (45.4 kg) load (drawer and top surface combined)

Part Number	Description H x W in (mm)	Shipping Weight lb (kg)
13082-X19	19" x 2U Drawer, 20 (510)	18 (8.2)
13083-X19	19" x 3U Drawer, 20 (510)	20 (9.1)
13084-X19	19" x 4U Drawer, 20 (510)	22 (10.0)
13082-X23	23" x 2U Drawer, 20 (510)	21 (9.5)
13083-X23	23" x 3U Drawer, 20 (510)	23 (10.4)
13084-X23	23" x 4U Drawer, 20 (510)	25 (11.3)

X=Color: 1=Gray, 5=Clear, 7=Black, E=Glacier White.



Snap-In Filler Panel

Snap-In Filler Panel blocks airflow in between equipment by sealing unused rack-mount spaces (U) in the cabinet. Use with Air Dam Kit and Bottom Panel to separate cold and hot air within the cabinet.

Part Number			Height (U)	Shipping Weight lb (kg)
Each (1)	Each (6)	Each (50)		
34537-X00	34537-X01	34537-X02	1U	14 (6.4)
34538-X00	34538-X01	34538-X02	2U	21 (9.5)

X=Color; 0=Black, E=Glacier White. Shipping Weights are for 50 pack.



Clik-Nut® Hardware Kit

Clik-Nut® Hardware Kit solves the fundamental issues with standard cage nuts. The design eliminates the need for tools, resulting in easier and faster installation, while maintaining load-bearing strength. Clik-Nut reduces labor and installation time by at least 70 percent.

Clik-Nut can be used wherever standard cage nuts are used and works anywhere along the rack panel surface when mounting, removing or repositioning IT equipment. Steel construction ensures the same load rating as standard cage nuts.

The squeeze-and-release design allows users to safely insert the Clik-Nut into mounting holes repeatedly, without the need for tools, reducing the risk of finger injuries or nuisances common during installation of traditional cage nuts.

- Multiple thread sets available: M6, 12-24, 10-32
- Engraved thread size provides easy identification
- Compatible with .375" (9.5 mm) square-punched holes in rails with thickness of 16 ga to 12 ga, .060" to .105" (1.52 mm to 2.67 mm)

Part Number	Thread Size	Package Of	Shipping Weight lb (kg)
76543-X01	M6 x 1.0	25	1 (0.5)
76543-X02	M6 x 1.0	250	6 (2.7)
76543-X03	M6 x 1.0	1000	23 (10.5)
76544-X01	12-24	25	1 (0.5)
76544-X02	12-24	250	6 (2.7)
76545-X01	10-32	25	1 (0.5)
76545-X02	10-32	250	6 (2.7)
76545-X03	10-32	1000	23 (10.5)

X=Color; 0=Zinc, 7=Black Zinc



Fixed Shelf

Use fixed shelves to support equipment without rack-mounted brackets such as modems, CPUs, small power supplies and monitors. Shelves mount to the Universal EIA 5/8" - 5/8" - 1/2" (15.9 mm - 15.9 mm - 12.7 mm) alternating hole pattern of the four vertical mounting rails, and three depths are offered in 18", 24" and 29" (460 mm, 610 mm and 740 mm). Shelves have adjustable mounting depths of 13" to 24" (330 mm to 610 mm) for the 18" (460 mm) shelf, 17" to 28" (430 mm to 710 mm) for the 24" (610 mm) shelf and 24" to 38" (610 mm to 970 mm) for the 29" (740 mm) shelf.

- Made of strong, lightweight aluminum
- Installs using (8) #12-24 screws (not included)
- Supports up to 200 lb (90.7 kg)
- 19" shelves are UL Listed: File E227626; Category NWIN - Accessories



12336-XXX



14070-XXX

Part Number	Description	Shipping Weight lb (kg)
12336-X19	19"W x 18"D (460 mm), Non-Vented	7 (3.2)
12337-X19	19"W x 18"D (460 mm), Vented	7 (3.2)
12334-X19	19"W x 24"D (610 mm), Non-Vented	9 (4.1)
12335-X19	19"W x 24"D (610 mm), Vented	9 (4.1)
14070-X19	19"W x 29"D (740 mm), Non-Vented	11 (5.0)
14072-X19	19"W x 29"D (740 mm), Vented	10 (4.5)
12336-X23	23"W x 18"D (460 mm), Non-Vented	8 (3.6)
12337-X23	23"W x 18"D (460 mm), Vented	8 (3.6)
12334-X23	23"W x 24"D (610 mm), Non-Vented	10 (4.5)
12335-X23	23"W x 24"D (610 mm), Vented	10 (4.5)
14070-X23	23"W x 29"D (740 mm), Non-Vented	12 (5.4)
14072-X23	23"W x 29"D (740 mm), Vented	11 (5.0)

X=Color: 1=Gray, 7=Black

Rack-Mount Cable Shelf

Use Rack-Mount Cable Shelf in any 19" W CPI cabinet equipped with an Air Dam Kit to provide a front-to-rear pathway for cables. Cables pass through brush-sealed ports along the front of the shelf. Rack-Mount Cable Shelf uses 1U and will fit in cabinets with mounting rails set between 22" and 40" D (560 mm and 1020 mm).



Part Number	Description	Shipping Weight lb (kg)
13517-701	1U x 19, Black	17 (7.7)

2U



Sliding Shelf

Shelves mount to the four vertical mounting rails. Two depths are offered in 18" and 24" (460 mm and 610 mm) to provide clearance for cables, ventilation and power strips. Shelves have adjustable mounting depths of 14" to 24" (360 mm to 610 mm) for the 18" (460 mm) shelf and 18" to 30" (460 mm to 760 mm) for the 24" (610 mm) shelf.

- Extends 17" (430 mm) for 18"D (460 mm) shelf and 23" (580 mm) for 24"D (610 mm)
- Offered in 18" (460 mm) or 24" (610 mm) depth, vented or non-vented
- Made of strong, lightweight aluminum
- Shelf locks in closed or fully open position, providing stability
- Ships fully assembled; installs using (8) #12-24 screws (not included)
- Fits cabinets that are 30"D (760 mm) or less
- Accommodates the Monitor Tie-Down Bracket, P/N 11725-X01
- Supports up to 140 lb (63.5 kg)

Part Number	Description	Shipping Weight lb (kg)
12338-X19	19"W x 18"D (460 mm), Non-Vented	7 (3.2)
12339-X19	19"W x 18"D (460 mm), Vented	7 (3.2)
12345-X19	19"W x 24"D (610 mm), Non-Vented	9 (4.1)
12346-X19	19"W x 24"D (610 mm), Vented	9 (4.1)
12338-X23	23"W x 18"D (460 mm), Non-Vented	8 (3.6)
12339-X23	23"W x 18"D (460 mm), Vented	8 (3.6)
12345-X23	23"W x 24"D (610 mm), Non-Vented	10 (4.5)
12346-X23	23"W x 24"D (610 mm), Vented	10 (4.5)

X=Color: 1=Gray, 7=Black

1U



12573-XXX

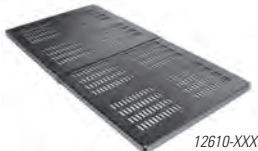

12610-XXX

Shelf extends from 20" - 36" (510 mm - 910 mm) in depth. Mounting brackets included but not shown.

Low Profile Fixed Shelf

Unique telescoping design delivers between 20" and 36" (510 mm and 910 mm) of continuous support for up to 100 lbs (45.4 kg) of equipment in less than 1U of rack-mount space.

- Shelf bracket provides front and rear support, attaching with single screw to mounting rails
- Available in 19" EIA and 23" EIA widths, providing 17.5" and 21.5" (445 mm and 546 mm) surface space respectively
- Made of steel
- Supports up to 100 lb (45.4 kg)
- 19" shelves are UL Listed

Part Number	Description	Shipping Weight lb (kg)
12573-X19	19"W Solid Shelf	16 (7.3)
12573-X23	23"W Solid Shelf	18 (8.2)
12610-X19	19"W Vented Shelf	15 (6.8)
12610-X23	23"W Vented Shelf	17 (7.7)

X=Color: 1=Gray, 7=Black

2U

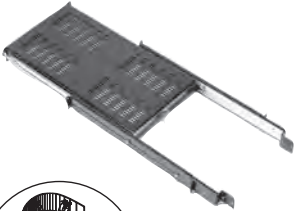

Flexible cable manager

32" Deep (810 mm) Sliding Shelf

Many storage solutions may cause kinking, twisting and cutting of cables during shelf extension and retraction. CPI's flexible polycarbonate belt, which fits in the rear undercarriage, solves these problems. This belt easily attaches to either the left or right side of the vertical bracket and contains eight molded releasable clips that accommodate cable bundles measuring up to 1" (25.4 mm) in diameter.

- Supports up to 160 lb (72.6 kg) using less than 2U
- Locks in the closed position
- Open easily with accessible front lock levers, providing greater stability while accommodating deep servers
- Maximum usable shelf space of up to 32" (810 mm)
- Cable management belt provides greater flexibility in the storage of wire bundles
- Designed for 36" or 39"D (910 mm or 990 mm) cabinets

Part Number	Description	Shipping Weight lb (kg)
11913-X19	Vented, 19"W x 32"D (810 mm) Sliding Shelf	25 (11.3)
11914-X19	Non-Vented, 19"W x 32"D (810 mm) Sliding Shelf	25 (11.3)
11913-X23	Vented, 23"W x 32"D (810 mm) Sliding Shelf	25 (11.3)
11914-X23	Non-Vented, 23"W x 32"D (810 mm) Sliding Shelf	25 (11.3)

X=Color: 1=Gray, 7=Black

2U

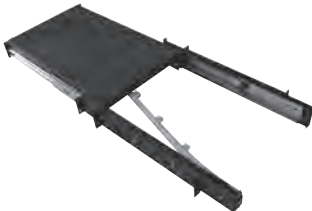

Patented shelf extends a full 24" (610 mm).

Extra Heavy Duty Sliding Shelf

Shelf supports up to 300 lb (136.1 kg) and uses only 2U, providing 26" (660 mm) usable depth.

- Flexible cable management belt eliminates kinking, bending or cutting of cable
- Adjustable mounting depth of 20" to 34" (510 mm to 860 mm)
- 19" shelf provides 17.5" (445 mm) usable width
- 23" shelf provides 21.5" (546 mm) usable width
- Locks in fully closed or open position

Part Number	Description	Shipping Weight lb (kg)
12700-X19	19"W Solid Shelf	29 (13.2)
12700-X23	23"W Solid Shelf	30 (13.6)

X=Color: 1=Gray, 7=Black, E=Glacier White



Aisle Containment Solutions

Aisle Containment Solutions by CPI utilize Passive Cooling® to create effective and efficient thermal solutions at every level of infrastructure deployment.

CPI's latest innovation in Aisle Containment has sharpened focus on total air isolation, resulting in a solution that helps reduce energy costs and optimizes power availability. The flexibility to deploy the containment system into the hot or cold aisle provides the ability to overcome facility challenges like limited ceiling height, complicated overhead pathways or the inability to add a drop ceiling or overhead return ducts. Frame Supported options support colocation facilities and roll in/roll out deployment, allowing cabinets to be added or omitted from contained aisles, while maintaining air isolation.

Currently available in these solutions:

- Build To Spec (BTS) Hot Aisle Containment (HAC)
- Cabinet Supported Cold Aisle Containment (CAC)

CPI Aisle Containment Solutions feature:

- Effectively utilize 100% of supplied air and reduce chilled air waste
- Improve CRAC efficiency because of the higher supply-to-return temperature differences
- Support 4x higher heat and power densities (6 kW to 30+ kW)
- Eliminate Hot Spots
- Allow increased room temperature, higher set points on cooling equipment and chilled water temperatures for more free cooling hours using low-cost economizers
- UL® Listed



PATENTED



Aisle Containment
Door Assembly
Double Door



Aisle Containment
Door Assembly Single
Door, Open to the Right



Aisle Containment
Door Assembly Single Door,
Open to the Left

Aisle Containment Door Assembly

Use with all CPI containment solutions. The door assembly encloses the end of an aisle between adjacent cabinet rows. Available in single- and double-door assemblies. Fits snugly against the cabinets, and features an integrated interior handle, full height vertical edge seals, height adjustable brush floor seals and a magnetic door seal. Automatic close system ensures maximum performance by minimizing airflow disruptions. Low-profile design conceals installation hardware.

- Door frames feature an integrated interior handle, full-height vertical-edge seals, height-adjustable brush floor seals and a magnetic door seal
- Automatic close system ensures maximum performance by minimizing airflow disruptions and includes a speed control damper for safe operation
- Detects open feature for easy access during extended service periods
- No threshold under the door when opened
- Low-profile design conceals floor installation hardware
- Door frames are anodized aluminum with a large, full-height, transparent polycarbonate window
- Door track is aluminum extrusion; end panels, cover and brackets are steel
- Not compatible with cabinets/frames less than 42"D (1050 mm) on 7 tile, 168" (4200 mm) pitch
- End panels are painted glacier white or black; option for paint matched door frames available

Dimensions (H x W x D), in (mm)

- For P/N 32770-XXX:
 - 1 size, assembly is 88.5"H x 106.9"W x 5.5"D (2248 mm x 2715 mm x 140 mm) with an 82"H x 42"W (2083 mm x 1067 mm) door opening
 - Spans 48"W to 72"W (1200 mm x 1800 mm) aisles (2 to 3 tiles)
- For P/N 32780-XXX:
 - 1 size, assembly is 88.5"H x 87.8"W x 5.4"D (2248 mm x 2231 mm x 137 mm) with an 82"H x 32"W (2083 mm x 810 mm) door opening
 - Spans 36"W to 48"W (910 mm x 1200 mm) aisles (1.5 to 2 tiles)
 - Retrofit solution for narrower 36" (910 mm) aisle clearance

Aisle Containment Door Assembly		
Part Number & Finish		Description
Black	Glacier White	
Double Door		
32770-701	32770-E01	With Painted Door Frames
32770-702	32770-E02	With Anodized Aluminum Door Frames
Single Door, Opens To The Right		
32780-702	32780-E02	With Painted Door Frames
32780-704	32780-E04	With Anodized Aluminum Door Frames
Single Door, Opens To The Left		
32780-701	32780-E01	With Painted Door Frames
32780-703	32780-E03	With Anodized Aluminum Door Frames

Notes: Double door spans two to three tile aisles and has a 42"W (1067 mm) door opening. Single door is right or left opening, spans two tile aisles and has a 32"W (812 mm) door opening. Order one Floor Mounting Template for each site.

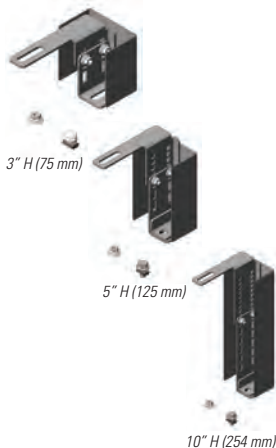

Door Mounting Bracket

Secures the Aisle Containment Door Assembly to the tops of the cabinets. Two versions for use with or without Door Standoff Kit (P/N 32870). Includes two brackets; available in three height ranges

- Compatible with ZetaFrame cabinets

Aisle Containment Door Assembly		
Part Number & Finish		Description
Black	Glacier White	
Door Mounting Bracket Kit (use with Standoff Kit)		
32805-703	32805-E03	3\"H (75 mm), For 85.3\"H (2167 mm) to 91.4\"H (2322 mm) Cabinets
32805-704	32805-E04	5\"H (125 mm), For 82.6\"H (2098 mm) to 94.2\"H (2393 mm) Cabinets
32805-705	32805-E05	10\"H (254 mm), For 77.8\"H (1976 mm) to 98.9\"H (2512 mm) Cabinets
32780-704	32780-E04	With Anodized Aluminum Door Frames
Door Mounting Bracket Kit (use without Standoff Kit)		
32805-700	32805-E00	3\"H (75 mm), For 85.3\"H (2167 mm) to 91.4\"H (2322 mm) Cabinets
32805-701	32805-E01	5\"H (125 mm), For 82.6\"H (2098 mm) to 94.2\"H (2393 mm) Cabinets
32805-702	32805-E02	10\"H (254 mm), For 77.8\"H (1976 mm) to 98.9\"H (2512 mm) Cabinets

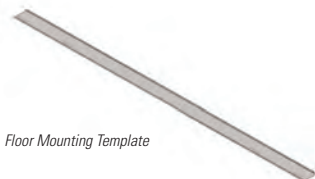

Floor Mounting Template

Floor Mounting Template

Provides a pattern for marking and drilling the floor when installing Aisle Containment Doors. Reusable, only one required.

Aisle Containment Door Assembly	
Part Number & Finish	Description
Black	
32875-701	For Aisle Containment Double-Door
32875-702	For Aisle Containment Single Door



Door Standoff Kit

Offsets door from the side of the cabinets, so floor mounting hardware is not located over the edges of the floor tiles. Provides approximately 2.5\" (64 mm) standoff.

Aisle Containment Door Assembly		
Part Number & Finish		Description
Black	Glacier White	
32870-701	32870-E01	For Containment Double Door Assembly
32870-702	32870-E02	For Containment Single Door Assembly

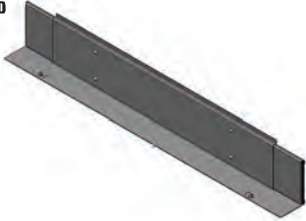

Door Top Seal Kit

Use with Cabinet Supported Solutions only. Flush mount and offset mount versions available in three size ranges. Seals the gap above the door when the door is attached to cabinets over 88" (2235 mm) tall.

Part Number & Finish		Description
Black	Glacier White	
Door Top Seal Kit, For Use With Door Standoff Kit		
32817-704	32817-E04	Adjusts from 48"W (1219 mm) to 59"W (1500 mm)
32817-705	32817-E05	Adjusts from 59"W (1500 mm) to 70"W (1775 mm)
32817-706	32817-E06	Adjusts from 70"W (1775 mm) to 81"W (2050 mm)
Door Top Seal Kit, For Use Without Door Standoff Kit		
32817-701	32817-E01	Adjusts from 48"W (1219 mm) to 59"W (1500 mm)
32817-702	32817-E02	Adjusts from 59"W (1500 mm) to 70"W (1775 mm)
32817-703	32817-E03	Adjusts from 70"W (1775 mm) to 81"W (2050 mm)



Build To Spec (BTS) Hot Aisle Containment (HAC) Solution

The Build To Spec Kit Hot Aisle Containment (HAC) Solution features a field-fabricated duct that is used over a contained hot aisle as part of a closed hot air return. This solution integrates with perimeter cooling, provides immediate improved cooling efficiency and is compatible with economization methods. It is ideal for retrofit applications over a mix of cabinets, including cabinets of varying heights, widths and depths.

Solution Overview

- Field-fabricated duct accommodates site differences and existing conditions
- Compatible with a mix of cabinets – different heights, widths and depths in the same row
- Elevated, single-piece duct allows cabinets to be removed, omitted or replaced as required
- Translucent duct panels and transparent door panels allow light to enter the contained aisle
- Doors close automatically to maintain containment and reduce recovery time
- A complete solution maximizes performance with baffles to seal around and within the cabinets and contained aisle
- Durable construction and maintenance-free design provide many years of use
- UL® Listed

Containment Accessories:

- Floor Mounting Template

- 1 Build To Spec Kit (BTS) – Includes all of the components needed to construct a ceiling-supported or cabinet-supported duct to capture and direct airflow in the contained aisle. This design adapts to a mix of cabinets and allows cabinets to be changed when required. Used as part of a closed return for the air handling system.
- 2 Universal Bulb Seal – Edge seal used around drop panels to seal gaps above shorter cabinets. Bulb seal attaches directly to the edge of the panel.
- 3 Full-Height Cabinet Blanking Panel – Translucent panel and seal used to fill gaps where entire cabinets are omitted from the cabinet row or when adjacent cabinet rows are different lengths. Easy to install or remove in the field.
- 4 Aisle Containment Door Assembly – Sliding double doors (shown) or single door, both with automatic closing feature and large transparent panel(s). Doors attach to the cabinets at the ends of the aisle to seal the ends of the contained aisle.
- 5 Door Standoff Kit – Optional kit used when cabinets are placed over a raised floor to offset the door approximately 2.5" (64 mm).
- 6 Door Top Seal Kit (not shown) – Optional kit used when doors are shorter than cabinets to seal the gap between the top of the door and the top of the cabinets.
- 7 Door Mounting Bracket Kit (not shown) – Adjustable height brackets used to attach the Aisle Containment Door Assembly to the tops of cabinets.
- 8 Aisle Containment Cabinet to Floor Seal Kit – Cabinet-specific trim panels used along the base of cabinets to seal the gap between the floor and the bottom of the cabinet frame.

BTS Ordering Information

The specific combination of components needed to create a complete BTS Hot Aisle Containment (HAC) Solution will depend on a number of factors, including room layout, ceiling height and what types of cabinets models are selected.

To ensure you have a complete solution that addresses site- and cabinet-specific requirements, please contact CPI Technical Support for assistance developing a Bill of Materials (BOM).

Based on your input, CPI Technical Support will propose a complete solution with a drawing and detailed BOM. They will take the time to explain each selection, so you have a complete understanding of how CPI solutions will provide desired results.

Example Bill Of Materials (BOM)			
Item	Part Number	Description	Qty
BTS Hot Aisle Containment (HAC) Solution			
1	33000-713	BTS Kit, 96"H (2438 mm) x 96"W (2438 mm) x 282"L (7163 mm), Black	1
2	33003-002	Universal Bulb Seal, 96"L (2438 mm), Pack of 10	1
3	33002-701	Full Height Cabinet Blanking Panel, 94"H (2387 mm) x 48"W (1219 mm), Pack of 2	1
4	32770-702	Aisle Containment Double Door Assembly, Black with Anodized Door Frames	2
5	32870-701	Door Standoff Kit, for Double Door Assembly	2
6	32817-706	Door Top Seal Kit, For Use With Door Standoff Kit, 70"W (1775 mm) to 81"W (2050 mm)	2
7	32805-703	Door Mounting Bracket Kit, 3"H (75 mm)	2
8	39208-700	Cabinet To Floor Front Seal Kit, 23.6"W (600 mm)	20
	39209-716	Cabinet To Floor Side Seal Kit, 47.2"D (1200 mm)	4
Recommended Accessories			
	32875-701	Installation Template, Aisle Containment Double Door Assembly	1
	34537-702	Snap-In Filler Panel, 1U x 19"EIA, Black, Pack of 50	2
	34538-702	Snap-In Filler Panel, 2U x 19"EIA, Black, Pack of 50	2
	13671-002	Raised Floor Grommet, 10 Pack, Black	2

For a more detailed analysis of your site, CPI offers a Pre-Installation Site Survey, a service where a CPI Technical Representative visits your site to provide a more detailed recommendation. To help ensure an optimized aisle containment installation, CPI offers On-Site Installation Supervision Services, which include related training and examination of the initial pods. Both Pre-Installation Site Surveys and On-Site Installation Supervision Support are especially important if there are special conditions, concerns or required customization.

All suggestions and performance statements are based on using an overall approach to airflow containment through the use of CPI products and solutions. For more information about CPI's Aisle Containment Services or products, call 800-834-4969, email techsupport@chatsworth.com or contact your Regional Sales Manager.

All products quoted are subject to availability based on manufacturing capacity, and shipping dates should be considered estimates only. While every effort has been made to ensure the accuracy of all information, CPI does not accept liability for any errors or omissions and reserves the right to change information and descriptions of listed services and products.



BTS Kit arrives on a pallet and includes eight unique components designed for easy installation and customization on-site.



BTS Kit assembled.

Notes:

- The BTS Kit includes the materials needed to create the duct over the cabinets and contained aisle.
- The duct should be slightly larger than the contained aisle; a minimum of 10" (250 mm) wider and 3" (75 mm) longer, so that it overlaps the adjacent cabinets.
- All containment packages come standard with adequate brackets to accommodate a ceiling- or cabinet-supported solution. Order ceiling or cabinet installation hardware separately.
- Doors, full-height cabinet blanking panels and additional materials for header/drop panels over cabinets must be ordered separately.

Part Number & Finish		BTS Kit						Ref Row Length by # of Tiles
		Description						
		Height		Width		Length		
Black	Glacier White	in	mm	in	mm	in	mm	
33000-701	33000-E01	48	1219	96	2438	94	2388	3
33000-702	33000-E02	48	1219	96	2438	188	4775	7
33000-703	33000-E03	48	1219	96	2438	282	7163	11
33000-704	33000-E04	48	1219	96	2438	376	9550	15
33000-705	33000-E05	48	1219	96	2438	470	11 938	19
33000-706	33000-E06	48	1219	96	2438	564	14 326	23
33000-707	33000-E07	48	1219	96	2438	658	16 713	27
33000-708	33000-E08	48	1219	96	2438	752	19 101	31
33000-709	33000-E09	48	1219	96	2438	846	21 488	35
33000-710	33000-E10	48	1219	96	2438	940	23 876	39
33000-711	33000-E11	96	2438	96	2438	94	2388	3
33000-712	33000-E12	96	2438	96	2438	188	4775	7
33000-713	33000-E13	96	2438	96	2438	282	7163	11
33000-714	33000-E14	96	2438	96	2438	376	9550	15
33000-715	33000-E15	96	2438	96	2438	470	11 938	19
33000-716	33000-E16	96	2438	96	2438	564	14 326	23
33000-717	33000-E17	96	2438	96	2438	658	16 713	27
33000-718	33000-E18	96	2438	96	2438	752	19 101	31
33000-719	33000-E19	96	2438	96	2438	846	21 488	35
33000-720	33000-E20	96	2438	96	2438	940	23 876	39
33000-721	33000-E21	48	1219	144	3658	94	2388	3
33000-722	33000-E22	48	1219	144	3658	188	4775	7
33000-723	33000-E23	48	1219	144	3658	282	7163	11
33000-724	33000-E24	48	1219	144	3658	376	9550	15
33000-725	33000-E25	48	1219	144	3658	470	11 938	19
33000-726	33000-E26	48	1219	144	3658	564	14 326	23
33000-727	33000-E27	48	1219	144	3658	658	16 713	27
33000-728	33000-E28	48	1219	144	3658	752	19 101	31
33000-729	33000-E29	48	1219	144	3658	846	21 488	35
33000-730	33000-E30	48	1219	144	3658	940	23 876	39
33000-731	33000-E31	96	2438	144	3658	94	2388	3
33000-732	33000-E32	96	2438	144	3658	188	4775	7
33000-733	33000-E33	96	2438	144	3658	282	7163	11
33000-734	33000-E34	96	2438	144	3658	376	9550	15
33000-735	33000-E35	96	2438	144	3658	470	11 938	19
33000-736	33000-E36	96	2438	144	3658	564	14 326	23
33000-737	33000-E37	96	2438	144	3658	658	16 713	27
33000-738	33000-E38	96	2438	144	3658	752	19 101	31
33000-739	33000-E39	96	2438	144	3658	846	21 488	35
33000-740	33000-E40	96	2438	144	3658	940	23 876	39



Universal Bulb Seal For BTS Kit

Edge seal that attaches to Polycarbonate Panel providing an edge seal for duct drop panels over cabinets. Trim length to match site requirements

- Includes: (2) or (10) each, 96" L (2387 mm) bulb seals
- Material: Plastic; bulb is flexible PVC (UL 94HB or UL 94V0), support is rigid PVC (UL 94V0), barbs in support are flexible Alcryn (UL 94HB)
- Flammability Standards: UL 94HB or UL 94V0
- Finish: Black

Part Number	Description
33003-001	96" L (2438), Pack of 2, Black
33003-002	96" L (2438), Pack of 10, Black

Note: Use as an edge seal around drop panels over cabinets.



Full Height Cabinet Blanking Panel; BTS Kit

Fills gaps when a cabinet is omitted from the aisle/cabinet row. Fits snugly and contains air in the enclosed hot aisle between the sides of adjacent rows.

Center panel is translucent and sides are painted. Includes horizontal and vertical seals; order hardware separately.

- Includes: 0.23" (6 mm) thick, 48" W (1219 mm) x 96" L (2387 mm) translucent panels, Universal Bulb Seal and aluminum extrusion supports
- Material: polycarbonate sheet and aluminum extrusion
- Surface Burning Characteristics of panels: ASTME E-84 (UL-723) Flame Spread Index = 0, Smoke Developed Index <=85.
- Finish: clear (translucent); extrusions are painted

Part Number & Finish		Description
Black	Glacier White	
33002-701	33002-E01	94" H (2387 mm) x 48" W (1219 mm), Pack of 2
33002-702	33002-E02	94" H (2387 mm) x 48" W (1219 mm), Pack of 10

Note: Center panel is translucent, sides and brackets are painted.



Corrugated Flute Cutter For BTS Kit

The Corrugated Flute Cutter is the best cutting tool for trimming the width of the corrugated panels used with CPI's Hot Aisle Containment (HAC) Solutions.

- Ergonomic handle for easier cutting compared to utility knife
- Notched blade with guides for cutting along flutes in material
- Insert the guide into the panel flute and pull through material to cut to width

Part Number	Description
33001-001	Corrugated Flute Cutter, 4 mm, Sold Each
33001-002	Corrugated Flute Cutter, 4 mm, Pack of 10



Cold Aisle Containment (CAC) Solutions

For information on CPI's CAC Solutions, please contact Tech Support at techsupport@chatsworth.com.



HCAI-OPM-0196

CUBE-IT® Wall-Mount Cabinet

CUBE-IT Wall-Mount Cabinets feature highly functional elements to provide class-leading support and storage of ICT equipment. CUBE-IT Cabinets allow easy access to the front and rear of the cabinet, making it ideal for telecommunications rooms. Additionally, high airflow vent pattern and optional low-decibel, dual-fan kit provides equipment cooling without interfering noise. The new modern, sleek design with range of options make the cabinet ideal for use in office spaces, conference rooms, classrooms, or any public spaces where floor space is limited.

The swing-out, three-part design secures equipment while maintaining ease of access for serviceability. CUBE-IT Wall-Mount Cabinet is accessed by a keyed lock on the front door. Once unlocked, an internal latch is accessible just inside the front door on the main chassis. Simply turn the lever to release the main chassis from the wall to gain access to the rear of equipment.

The cabinet body delivers exceptional strength and rigidity. The UL 2416 Listed 300 lb (136 kg) load-rating provides tested support for heavier equipment. For an updated look with a robust, high-quality viewing panel, the front door has an optional tempered glass window. Use CUBE-IT Wall-Mount Cabinet to meet growing demands, Power over Ethernet (PoE) deployments, faster wireless and premise networks, audio and video equipment, security and monitoring equipment and smart building initiatives.

The removable top and bottom rear panels feature a rectangular cable pass-through knockout with optional brush seals, providing a larger opening for cables that can accept patch panels, making CUBE-IT a great solution for retrofit and existing infrastructure, or for use with factory-terminated structured cabling.

Features:

- Three-part, swing-out design allows access and service to the front and rear of equipment
- A single lock and key (CH751) on the front door provides access to the entire cabinet
- Rear panel includes 1" (25.4 mm) and 3" (76 mm) knockouts, and can accept 3/4" (19 mm) and 2.5" (63.5 mm) conduit. The 3" (76 mm) knockouts include edge-protection grommets
- Rear panel features cable tie and attachment points for accessory rack-mount brackets
- UL® 2416 Listed, 300 lb (136 kg) load rating
- Internal latch mechanism secures the rear panel; slim-profile does not impact cabling space
- Hinge design allows the installer to remove the rear panel for easier installation on the wall
- Cabinet body includes one pair of adjustable depth 19" EIA threaded equipment mounting rails
- Cable pass-through knockout with optional brush seal makes it ideal for retrofit installations
- Optional low-decibel (31 dB), dual-fan kit provides quiet operation while cooling equipment
- Factory-prepped bonding feature provides convenience and reduces installation time
- Ships fully assembled



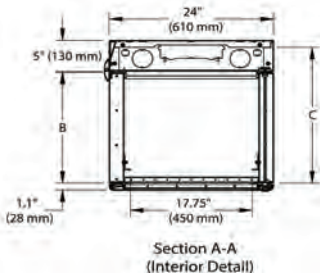
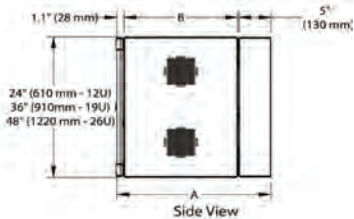
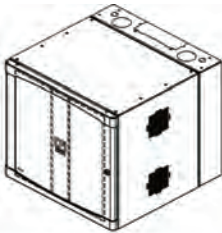

CUBE-IT Wall-Mount Cabinet

- Attaches to the wall with included installation hardware
- Available in 12U, 19U and 26U heights, with solid metal or tempered glass door options
- All cabinet styles are 24"W (610 mm)
- Includes CH751 keyed locks

Part Number	Cabinet Depth	Door Style	Shipping Weight lb (kg)
24"H (610 mm) CUBE-IT Cabinet			
11890-X24	18" (460 mm)	Solid	90 (40.9)
11901-X24	18" (460 mm)	Tempered Glass	90 (40.9)
11840-X24	24" (610 mm)	Solid	101 (45.9)
11900-X24	24" (610 mm)	Tempered Glass	101 (45.9)
11996-X24	30" (760 mm)	Solid	112 (50.9)
12419-X24	30" (760 mm)	Tempered Glass	112 (50.9)
36"H (910 mm) CUBE-IT Cabinet			
11890-X36	18" (460 mm)	Solid	114 (51.8)
11901-X36	18" (460 mm)	Tempered Glass	114 (51.8)
11840-X36	24" (610 mm)	Solid	128 (58.2)
11900-X36	24" (610 mm)	Tempered Glass	128 (58.2)
11996-X36	30" (760 mm)	Solid	142 (64.5)
12419-X36	30" (760 mm)	Tempered Glass	142 (64.5)
48"H (1220 mm) CUBE-IT Cabinet			
11890-X48	18" (460 mm)	Solid	139 (63.2)
11901-X48	18" (460 mm)	Tempered Glass	139 (63.2)
11840-X48	24" (610 mm)	Solid	155 (70.5)
11900-X48	24" (610 mm)	Tempered Glass	155 (70.5)
11996-X48	30" (760 mm)	Solid	171 (77.7)
12419-X48	30" (760 mm)	Tempered Glass	171 (77.7)

Note: X=Color; 7=Black and E=Glacier White

Overall Depth (A)	Cabinet Body Depth (B)	Max. Equipment Depth (C)
18" (460 mm)	11.7" (297 mm)	15.9" (403 mm)
24" (610 mm)	17.7" (449 mm)	21.9" (556 mm)
30" (760 mm)	23.7" (602 mm)	27.9" (708 mm)

CUBE-iT Wall-Mount Cabinet Accessories

Cable Port Brush Kit

- Optional cover when rectangular knockout on the rear panel is removed
- Seals opening around cables with brush seal
- Sold in pairs



Foot Kit

- For use on desktops or floor when not installed on a wall
- Pack of 4



Equipment Mounting Rail Kit

- Use with equipment that needs front and rear support
- Sold in pairs
- Aluminum material

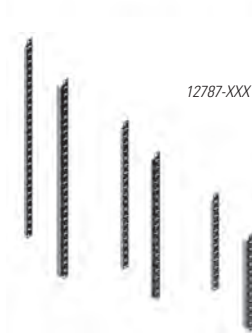

Part Number	Description	Shipping Weight lb (kg)
25190-000	Cable Port Brush Kit 0.8"H x 10.6"W x 2.9"D (20 mm x 268 mm x 74 mm)	2 (0.9)
13483-001	Foot Kit	2 (0.9)
12787-524	Equipment Mounting Rail Kit 12U; For 24"H (610 mm) cabinet	4 (1.8)
12787-536	Equipment Mounting Rail Kit 19U; For 36"H (910 mm) cabinet	6 (2.7)
12787-548	Equipment Mounting Rail Kit 26U; For 48"H (1220 mm) cabinet	8 (3.6)

Note: CUBE-iT Wall-Mount includes one pair of Equipment Mounting Rails



CUBE-IT® Wall-Mount Floor-Supported Cabinet

The CUBE-IT Wall-Mount Floor-Supported Cabinet is designed to secure communications equipment for a cross connect. CUBE-IT Cabinets are copper- and fiber-ready and feature easy access to the front or the rear of the cabinet.

The swing-out, three-part design secures equipment while maintaining ease of access for serviceability. CUBE-IT Wall-Mount Floor-Supported Cabinet is accessed by a keyed lock on the front door. Once unlocked, an internal latch is accessible just inside the front door on the main chassis. Simply turn the lever to release the main chassis from the wall to gain access to the rear of equipment. Additionally, the cabinet is configurable for right or left swing.

The 5"D (130 mm) rear panel provides a space for terminating cables. The rear panel is prepunched along the top and bottom with conduit knockouts, allowing communications and power cables to be securely routed into the cabinet. Grommets are included to protect cables when conduit is not used. The interior of the rear panel has tie points for cables and attachment points for accessory equipment mounting brackets.

The main cabinet body includes two pairs of adjustable depth 19" EIA square-punched equipment mounting rails that can be used to support interconnect equipment and/or active components. The cabinet includes 50 units of Klik-Nut Hardware kit for quick, safe equipment mounting. Multiple fan options provide efficient equipment cooling.

Features:

- Three-part, swing-out design allows access and service to the front and rear of equipment. The cabinet body is supported on the floor by an attached wheeled base.
- A single lock and key on the front door provides access to the entire cabinet
- Cabinet body includes two pairs of adjustable depth 19" EIA square-punched equipment mounting rails and Klik-Nut Hardware Kit
- Rear panel includes 1" (25.4 mm) and 3" (76 mm) knockouts, and can accept 3/4" (19 mm) and 2.5" (63.5 mm) conduit. Edge-protection grommets are included for the 3" (76 mm) knockouts
- Rear panel features fixing points for cable slack management and attachment points for accessory rack-mount brackets
- Optional low-decibel (31 dB), dual-fan kit provides quiet operation while cooling equipment
- Factory-prepped bonding feature provides convenience and reduces installation time



CUBE-IT Wall-Mount Floor-Supported Cabinet

- Wall-mount, floor-supported enclosure with lockable front door and swing-out rear access to equipment
- EIA/ECA-310-E compliant
- 1000 pounds (453.6 kg) of equipment open or closed
- Load bearing casters
- All cabinet styles are 27.3"W (693 mm)

Part Number	Cabinet Depth	Door Style	Shipping Weight lb (kg)
60"H (1520 mm) CUBE-IT Cabinets			
13492-X60	24" (610 mm)	Solid	248 (112.7)
13493-X60	30" (760 mm)	Solid	260 (118.2)
13495-X60	24" (610 mm)	Tempered Glass	278 (126.4)
13496-X60	30" (760 mm)	Tempered Glass	290 (131.8)
72"H (1830 mm) CUBE-IT Cabinets			
13492-X72	24" (610 mm)	Solid	296 (134.5)
13493-X72	30" (760 mm)	Solid	309 (140.5)
13495-X72	24" (610 mm)	Tempered Glass	329 (149.5)
13496-X72	30" (760 mm)	Tempered Glass	342 (155.5)

Note: X=Color; 7=Black and E=Glacier White

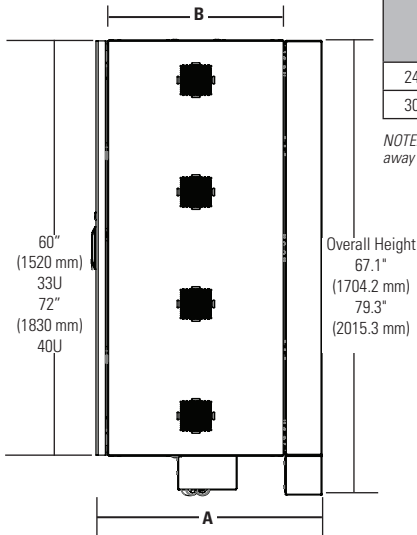

Overall (A)	Cabinet Body (B)	Max. Rail-to-Rail Spacing	Max. Equipment Depth
24.9" (633 mm)	18.1" (460 mm)	16.7" (424 mm)	22.2" (564 mm)
30.9" (785 mm)	24.1" (612 mm)	22.7" (576 mm)	28.2" (716 mm)

NOTE: Maximum equipment depth denotes values that still allow the center chassis to swing away from rear panel.

Low-Decibel Dual-Fan and Filter Kit

- Pressurizes interior of the cabinet, forcing warm air out of open vents
- Assembly Includes 2 fans and 2 filters
- Noise Level: 31 dB (measured at 3' (1 m) distance)
- Recommended placement on bottom right and left sides of the cabinet
- Airflow: 120 CFM (204 CMH)
- 6'L (1.8 m) NEMA 5-15P/6-15P Power Cord

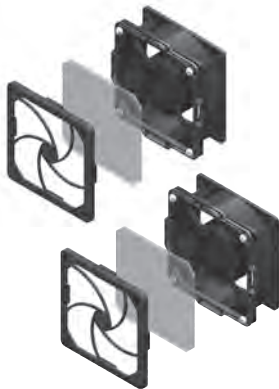

Part Number	Description	Shipping Weight lb (kg)
40975-001	115 Volt, 50/60 Hz, 5-15P power cord	2 (0.8)
40975-002	230 Volt, 50/60 Hz, 6-15P Power cord	2 (0.8)
40973-001	Replacement Filter Kit, Pack of 5	2 (0.8)

Standard Fan and Filter Kit

- Pressurizes interior of the cabinet, forcing warm air out of open vents
- Assembly Includes 1 fan, 1 filter, and 1 vent cover
- Noise Level: 39 dB (measured at 3' (1 m) distance)
- Airflow: 115 CFM (170 CMH)
- 6'L (1.8 m) NEMA 5-15P/6-15P Power Cord within the cabinet. It attaches to the cabinet with standard #12-24 rack screws (Included in the ThinLine II Cabinet's hardware kit).



Part Number	Description	Shipping Weight lb (kg)
40972-001	115 Volt, 50/60 Hz, 5-15P power cord	2 (0.8)
40972-002	230 Volt, 50/60 Hz, 6-15P Power cord	2 (0.8)
40973-001	Replacement Filter Kit, Pack of 5	2 (0.8)

Bonding Jumper Kit

- Provide common bonding from equipment rack or cabinet to halo conductor
- Available individually or in packages of 10
- Constructed of UL Listed components



Part Number	Description	Shipping Weight lb (kg)
40159-009	9' (2.7 m) Bonding Jumper, 1 Each	2 (0.9)
40159-019	9' (2.7 m) Bonding Jumper, 10 Each	20 (1.9)

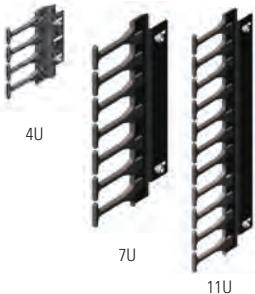

Vertical Cabling Section

- Attaches to the outside edge of equipment mounting rails
- Openings align with rack-mount unit spaces on equipment mounting rails
- Sold in pairs
- Order additional kits as-needed per cable management requirements

Part Number	Description	Shipping Weight lb (kg)
40970-704	4U, 7"H x 0.5"D (178 mm x 13 mm)	3 (1.4)
40970-707	7U, 12.3"H x 0.5"D (311 mm x 13 mm)	3 (1.4)
40970-711	11U, 19.3"H x 0.5"D (489 mm x 13 mm)	4 (1.8)



CUBE-IT Wall-Mount
24", 36" & 48"

CUBE-IT Wall-Mount
Floor Supported
60" & 72"

Vertical Lashing Bracket

- Provides multiple lashing points for premise cables
- Attaches to center chassis with included hardware
- Adjustable front-to-rear

Part Number	Description	Shipping Weight lb (kg)
40971-X24	24"H x 4"W (610 mm x 100 mm)	4 (1.8)
40971-X36	36"H x 4"W (910 mm x 100 mm)	6 (2.7)
40971-X48	48"H x 4"W (1220 mm x 100 mm)	8 (3.6)
For Wall-Mount Floor Supported Cabinets		
40971-X60	60"H x 4"W (1520 mm x 100 mm)	4 (1.8)
40971-X72	72"H x 4"W (1820 mm x 100 mm)	6 (2.7)

Note: X=Color; 7=Black and E=Glacier White

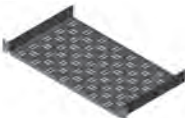

40974-X19

CUBE-IT Cabinet Accessories

Rack Mount Shelf

- For use with small equipment such as modems, routers and fiber modules in 19" EIA racks
- 1U; Includes multiples tie-down points
- Supports up to 20 lb (9.1 kg) of equipment



11837-X02

Horizontal Wire Management Bar

- Attaches to the rear of the equipment mounting rails in CUBE-IT Cabinet
- Includes mounting hardware and 12 cable ties



12803-701

LED Light Kit

- Attaches to the bottom, top or side of CUBE-IT Cabinets
- Toggle switch, 4W LED light
- Detachable, 120 VAC with NEMA 1-15P Power Cord



13285-501

90° Mounting Bracket

- Attaches to rear panel on CUBE-IT Cabinets
- Creates a 19" EIA x 2U vertical rack-mount space
- 2 brackets per kit, 3.9"H x 1"W x 4"D (99 mm x 25.4 mm x 101.6)



12820-XXX

Power Strip

- Select straight or locking plug style
- 115 VAC; 15 Amp or 20 Amp
- 10'L (3 m) power cord and circuit breaker
- Includes (8) 5-20R outlets

Note: Surge-Protected options available.

Part Number	Description	Shipping Weight lb (kg)
40974-X19	Rack-Mount Shelf, 1U x 19"W x 10"D (483 mm x 250 mm)	4 (1.8)
11837-701	Wire Management Bar, for CUBE-it Wall-Mount Cabinet, 1.5"H x 19.3"W x 3.7"D (38 mm x 490 mm x 94 mm)	4 (1.8)
11837-702	Wire Management Bar, for CUBE-IT Wall-Mount Floor-Supported Cabinet, 1.5"H x 19.3"W x 3.7"D (38 mm x 490 mm x 94 mm)	4 (1.8)
12803-701	LED Light Kit, 4W, 120 Vac	2 (0.9)
13285-501	90° Mounting Bracket, (1) Pair, Clear	3 (1.4)
12820-701	15A Power Strip, NEMA 5-15P	4 (1.8)
12820-702	15A Power Strip, NEMA L5-15P	4 (1.8)
12820-705	20A Power Strip, NEMA 5-20P	4 (1.8)
12820-706	20A Power Strip, NEMA L5-20P	4 (1.8)
12820-703	15A Power Strip, NEMA 5-15P, Surged Protected	4 (1.8)
12820-704	15A Power Strip, NEMA L5-15P, Surged Protected	4 (1.8)
12820-707	20A Power Strip, NEMA 5-20P, Surged Protected	4 (1.8)
12820-708	20A Power Strip, NEMA L5-20P, Surged Protected	4 (1.8)

X=Color: 7=Black, E=Glacier White

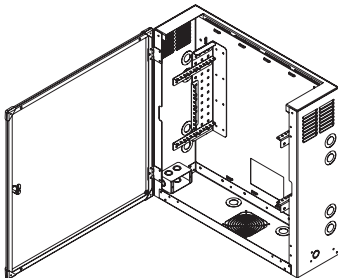

ThinLine II can hold a server, switch, horizontal cable manager, patch panel, fiber service loop and fiber-optic patch panel—with room to accommodate additional mounting needs.

ThinLine® II Wall-Mount Cabinet

The ThinLine II maximizes interior space using a distinctive equipment mounting rail system. Individual rails can be easily rotated for horizontal or vertical mounting and then bolted into place making patch panel punchdown easier. The cabinet can hold a server, switch, horizontal cable manager, patch panel, fiber service loop and fiber-optic patch panel — with room to accommodate additional mounting needs.

An easy-to-remove top panel slides in and out of position (without tools) using a spring button release. In addition, the 26" H (660 mm) cabinet can be mounted so that the removable "top" panel becomes a side panel.

A 4" x 6" (100 mm x 150 mm) opening in the rear of the cabinet and knockouts sized 3/4" and 1-1/2" allow cable entry and exit. Also features multiple cable tie-down points in rear panel.

- Door features rounded edges and corners and can be mounted to open from either right or left
- Removable top panel provides direct access to equipment without disturbing other devices
- Multiple sets of knockouts allow flexibility in cable organization
- Louvers and fan accessory provide ventilation
- Cabinet includes a 2" x 4" (50 mm x 100 mm) junction box to hold an optional surge-suppressed duplex outlet, eliminating the need for a power strip
- Made of steel
- Ships fully assembled with mounting hardware
- Static load rating is 100 lb (45.4 kg)

Part Number	Description	Shipping Weight lb (kg)
26" H (660 mm) ThinLine II		
13050-X11	26 x 26 x 5, 2U, (660 x 660 x 130)	47 (21.3)
13050-X12	26 x 26 x 8.5, 4U, (660 x 660 x 216)	54 (24.5)
13050-X13	26 x 26 x 12, 6U, (660 x 660 x 300)	60 (27.2)
36" H (910 mm) ThinLine II		
13050-X21	36 x 26 x 5, 2U, (910 x 660 x 130)	60 (27.2)
13050-X22	36 x 26 x 8.5, 4U, (910 x 660 x 216)	68 (30.8)
13050-X23	36 x 26 x 12, 6U, (910 x 660 x 300)	76 (34.5)

X=color: 1=Gray, 7=Black



Fiber Slack Manager Panel

The Fiber Slack Manager Panel provides both fiber slack management and a mounting surface for a small fiber manager or fiber-optic patch panel. Secured under the outermost mounting units, the panel takes up no mounting space within the cabinet. It attaches to the cabinet with standard #12-24 rack screws (Included in the ThinLine II Cabinet's hardware kit).

Part Number	Description	Color	Shipping Weight lb (kg)
12955-719	19" Rack-Mount	Black	2 (0.9)



Surge-Suppressed Duplex Receptacle

The cabinet can be easily configured with two surge-suppressed outlets, eliminating the need for a power strip. ThinLine II includes an electrical junction box that can be mounted on either side of the cabinet. A 1/2" or 3/4" knockout is provided.

Part Number	Description	Shipping Weight lb (kg)
12934-001	Receptacle, 125V, 15A	2 (0.9)



13501-001

Intelligent Fan Kit

The ThinLine II Intelligent Fan Kit uses a solid state temperature control to vary fan speed from an ultra quiet low speed at low air temperature through increasingly higher speeds as temperature rises.

Part Number	Description	Shipping Weight lb (kg)
13051-001	115 VAC, 60 Hz, 4U/6U Cabinets	2 (0.9)
13051-002	115 VAC, 60 Hz, 2U Cabinet	2 (0.9)

13051-001 Intelligent Fan Specifications:

Minimum Fan Speed

(air temp 77° or less)

65 CFM (Free Air)

34 dB (Noise Level)

Maximum Fan Speed

(air temp 104° or greater)

120 CFM (Free Air)

51 dB (Noise Level)

13051-002 Intelligent Fan Specifications:

Minimum Fan Speed

(air temp 77° or less)

36 CFM (Free Air)

28 dB (Noise Level)

Maximum Fan Speed

(air temp 113° or greater)

49 CFM (Free Air)

33 dB (Noise Level)

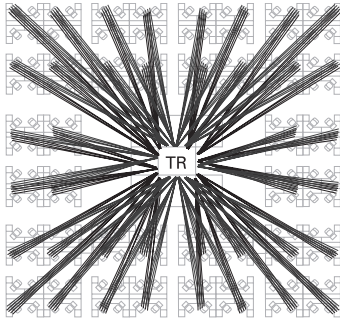

Traditional, Home Run Wiring

Telecommunication Enclosures

In traditional cabling models, cables extend from a centralized telecommunication room to each work area. Cable changes impact the entire length of cable between the central room and the work area and can be disruptive to workers within the workspace.

In zone cabling, floor space is divided into zones (typically the area between structural building columns), and an enclosure is placed near the center of the zone to house a consolidation point. Thus, only the cable between the consolidation point and work area is impacted when a network connection is changed, reducing the amount of material, labor and workspace disruption involved in the change.

Alternately, an active component (such as a switch) can be placed within the enclosure, essentially creating a "mini-telecommunication room" within the workspace. When fiber is routed into the enclosure, an easily scalable network is created via the active component. The customer's network is thus positioned to allow fiber to the desktop when desired.

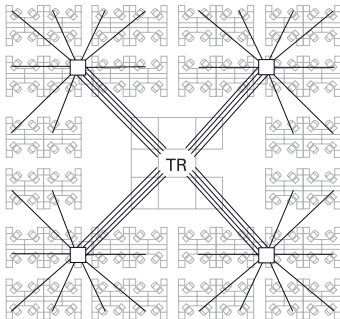

Zone Cabling

Zone cabling is an ideal solution to support networked areas with high "churn" (such as rented commercial office space, data centers, laboratories, schools, hospitals, retail operations, warehouses and industrial environments) or for use in any building that does not have planned space for a telecommunication room.

CPI offers Telecommunication Enclosures for use in drop ceilings and access floors. Product applications and model information are given on the following pages.

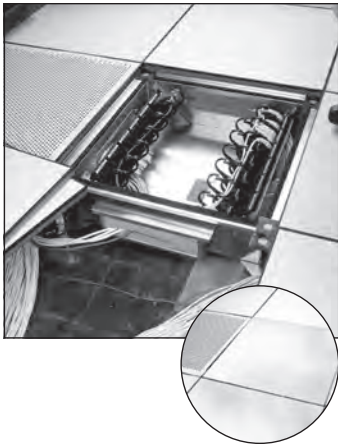

Raised Floor Enclosures

Raised Floor Enclosures fit under a single 2' x 2' access floor tile. Most models use the access floor tile as a "lid." Enclosures are UL Listed, suitable for low voltage and active applications and for use in air handling spaces.

A variety of sizes are available to match floor height. Most models include brackets for attachment to access floor support pedestals. Enclosures include threaded equipment mounting rails and have multiple, edge-protected cable access ports with foam sealing kits. All enclosures are finished clear.

In enclosures designed for use in low height floors, two facing pairs of pivoting equipment mounting rails are used to provide easy access to the front and rear of the patch panel. In deeper enclosures, rails that are parallel to the floor provide higher consolidation point capacity. There is also a model with a lift out tray that can support active components. Order #12-24 equipment mounting screws (P/N 40605-001) separately.

Raised Floor Enclosures For Patch Panels

These enclosures use the access floor tile as a "lid." (All models, except A0222-RF, include access floor installation brackets.)

- A0222-RF features four cable access ports 6" x 3/4" (152 mm x 19 mm); 19" EIA threaded equipment mounting rails "pivoting"
- A0422-RF features four cable access ports 6" x 3/4" (152 mm x 19 mm); 19" EIA threaded equipment mounting rails "pivoting"
- A0622-RF features four cable access ports 6-3/4" x 2" (171 mm x 50 mm); 19" EIA threaded equipment mounting rails "pivoting"
- A0822-RF features four cable access ports 6-3/4" x 2" (171 mm x 50 mm); 19" EIA threaded equipment mounting rails "pivoting"
- 13772-001 features larger cable openings for Cat 6a cables; two ports 14-3/4" x 3-1/4" (374 mm x 82mm) and two ports 6-1/4" x 7" (158.8 mm x 180 mm); 19" EIA threaded equipment mounting rails "pivoting"
- A1422-RF features four cable access ports 9-3/4" x 2-3/4" (247 mm x 69 mm); 19" EIA threaded equipment mounting rails "fixed"
- 13772-002 features larger cable openings for Cat 6a cables; six ports 14-3/4" x 3-1/4" (374 mm x 82 mm); 19" EIA threaded equipment mounting rails "pivoting"



A0822-RF



A1422-RF

Part Number	Description Depth in (mm)	Shipping Weight lb (kg)
A0222-RF	1U+1U Enclosure for 2 (50) Floor	10 (4.5)
A0422-RF	1U+1U Enclosure for 4 (100) Floor	10 (4.5)
A0622-RF	2U+2U Enclosure for 6 (150) Floor	23 (10.4)
A0822-RF	4U+4U Enclosure for 8 (200) Floor	23 (10.4)
13772-001	4U+4U Enclosure for 8 (200) Floor, Large Ports	25 (11.3)
A1422-RF	11U Enclosure for 14 (360) Floor	30 (13.6)
13772-002	4U+4U Enclosure for 14 (360) Floor, Large Ports	30 (13.6)



A0822-RF-F

Raised Floor Enclosure For Fiber

Prepare your data center for future changes by prewiring it with fiber connections located under an access floor.

- Fits under a single 2' x 2' access floor tile
- A0822-RF-F features two 7" x 2" (180 mm x 50 mm) cable access ports and 19" EIA threaded equipment mounting rails with 4U of rack-mount unit space
- A1422-RF-F features two 10" x 2-1/2" cable access ports and 19" EIA threaded equipment mounting rails with 6U of U space
- Equipment mounting rails can be centered or offset in the enclosure to accommodate angled patch panels or longer electronics
- Cable tie points simplify cable management
- Includes (4) access floor support brackets

Part Number	Description Depth in (mm)	Shipping Weight lb (kg)
A0822-RF-F	4U Fiber Enclosure for 9 (230) Floor	30 (13.6)
A1422-RF-F	6U Fiber Enclosure for 14 (356) Floor	30 (13.6)



A1411-RF-HR

Raised Floor Enclosure For Active Component

Features a lift-out tray for 2U x 10-1/4"D (260.4 mm) of active components and 5U (divided 2U - 1U - 2U) for passive connectivity.

- Includes a junction box for a duplex power outlet
- Includes fan to remove heat generated by active components

Part Number	Description Depth in (mm)	Shipping Weight lb (kg)
A1411-RF-HR	7U Enclosure for 14 (360) Floor	30 (13.6)



A0802-RF-DI

Raised Floor Enclosure With Locking Cover For Patch Panels

"Drop-In" enclosure measures 21-1/4" x 22-1/4" (539.8 mm x 565.2 mm) and includes a locking cover for use completely below access floor tiles. Installation only requires the removal of one floor tile.

- Features pivoting mounting rails similar to models above and is perfect for existing data centers

Part Number	Description Depth in (mm)	Shipping Weight lb (kg)
A0802-RF-DI	4U+4U Enclosure for 9 (230) Floor	25 (11.3)

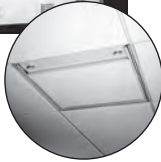

Ceiling Enclosures

Ceiling Enclosures fit within a single 2' x 2' or 2' x 4' space, replacing a standard acoustical ceiling tile. The enclosure's face and interior are painted white and have recessed panels to support a ceiling tile, so that they blend with the drop ceiling. A fully hinged door panel with latch closures supports equipment. The door opens downward so that equipment is facing the service technician. Three door styles are available to support wiring blocks, patch panels or active components. Door locks are available as an accessory.

Ceiling Enclosures are UL Listed, suitable for low voltage and active applications and for use in air handling spaces.

- 2' x 2' enclosures support 70 lb (31.8 kg) of cables and equipment and 20 lb (9.1 kg) on the access door
- 2' x 4' enclosures support 80 lb (36.3 kg) of cables and equipment and 50 lb (22.7 kg) on the pneumatic assisted access door
- Enclosures fit in 12"H (300 mm) drop ceilings and attach to building structure with four or six 3/8" threaded rods (ordered separately)
- Includes two or four edge-protected cable access ports with fire-rated foam sealing kits



A1222-HR

Ceiling Enclosure For Hubs, Switches And Patch Panels

Telecommunication enclosure supports a combination of active components and patch panels or other panel-mount termination hardware. Enclosures include a junction box for power and a fan to remove heat generated by active components.

- A1222-HR provides 5U for patch panels and 2U x 15"D (380 mm) for active equipment; equipment mounts on the door
- 13812-001 provides larger cable openings for Cat 6a; one 3-1/4" x 14-3/4" (82.6 mm x 374.7 mm) and one 6-1/4" x 6-7/8" (158.8 mm x 174.6 mm)
- A1024-HR provides 5U for patch panels and 2U x 15"D (380 mm) for active equipment; equipment mounts on the door
- A1224-HR provides a total of 10U with (3) brackets sized 4U - 2U - 4U to support a combination of patch panels and 15"D (380 mm) or less active equipment; brackets may be mounted on the door or the back of the enclosure
- Order #12-24 equipment mounting screws separately

Part Number	Description	Shipping Weight lb (kg)
A1222-HR	2' x 2' Ceiling Enclosure	39 (17.7)
13812-001	2' x 2' Ceiling Enclosure, Large Ports	40 (18.1)
A1024-HR	2' x 4' Ceiling Enclosure	47 (21.4)
A1224-HR	2' x 4' Ceiling Enclosure	45 (20.4)



Ceiling Enclosure For Patch Panels

Secure a consolidation point using 19" patch panels or other panel-mount termination hardware.

- A1222-PP provides a total of 5U with (3) brackets sized 2U - 1U - 2U; brackets mount on the door
- 13812-002 provides larger cable openings for Cat 6a; one 3-1/4" x 14-3/4" (82.6 mm x 374.7 mm) and one 6-1/4" x 6-7/8" (158.8 mm x 174.6 mm)
- A1024-PP provides a total of 5U with (3) brackets sized 2U - 1U - 2U; brackets mount on the door
- A1224-PP provides a total of 10U with (3) brackets sized 4U - 2U - 4U; brackets may be mounted on the door or the back of the enclosure
- Order #12-24 equipment mounting screws separately

Part Number	Description Depth in (mm)	Shipping Weight lb (kg)
A1222-PP	2' x 2' Ceiling Enclosure	38 (17.2)
13812-002	2' x 2' Ceiling Enclosure, Large Ports	39 (17.7)
A1024-PP	2' x 4' Ceiling Enclosure	43 (19.6)
A1224-PP	2' x 4' Ceiling Enclosure	45 (20.4)
13813-001	Ceiling Enclosure Fan Kit & Junction Box	3 (1.4)

Fan Kit & Junction Box, included with 13812-001, can be installed on either 13812-002 or 13812-003 to better support active components.



Ceiling Enclosure For Wiring Blocks

Secure a consolidation point using wiring blocks. Enclosures include removable equipment mounting plates that can be match drilled to accommodate a wide variety of wiring blocks.

- A1222-LP has (1) mounting plate, size 13-3/4"W x 19-1/2"L (349 mm x 495 mm) for (2) 300-pair 110D (without legs) style blocks or (1) 300-pair 110A (with legs) style blocks
- 13812-003 provides larger cable openings for Cat 6a; one 3-1/4" x 14-3/4" (82.6 mm x 374.7 mm) and one 6-1/4" x 6-7/8" (158.8 mm x 174.6 mm)
- A1024-LP has (1) mounting plate, 16"W x 22"L (406 mm x 559 mm) for (2) 300-pair 110A (with legs) style blocks
- A1224-LP has (2) mounting plates, size 13-3/4"W x 19-1/2"L (349 mm x 495 mm) for (4) 300-pair 110D (without legs) style blocks or (2) 300-pair 110A (with legs) style blocks

Part Number	Description Depth in (mm)	Shipping Weight lb (kg)
A1222-LP	2' x 2' Ceiling Enclosure	38 (17.2)
13812-003	2' x 2' Ceiling Enclosure, Large Ports	39 (17.7)
A1024-LP	2' x 4' Ceiling Enclosure	43 (19.6)
A1224-LP	2' x 4' Ceiling Enclosure	45 (20.4)



Basic Consolidation Enclosures

Basic Consolidation Enclosures (BCE) provide a low-cost, low-density consolidation point for telecommunication cabling. Both Ported (-P) and Non-Ported (-N) enclosures can be configured to be used either above the drop ceiling or below an access floor. All Ported versions (-P) come with a fire-rated foam sealing kit, making them suitable for air handling spaces. Basic Consolidation Enclosures are UL Listed (2043), plenum rated and come with a sealed door and a clear aluminum finish.



BCE-6-P

BCE-6-P

BCE-6-P measures 14"W x 6"D x 20"L (360 mm x 150 mm x 510 mm) and includes installation brackets for attachment to building structure with 3/8" threaded rods. (Equipment mounting brackets not included.)

Part Number	Description	Shipping Weight lb (kg)
BCE-6-P	2-Port Enclosure	7 (3.2)



BCE-24-P

BCE-24-P/N

BCE-24-P/N measures 14"W x 3"D x 20"L (360 mm x 80 mm x 510 mm). It includes rotating threaded interior mounting brackets for 1U of 19"W patch panel. Order #12-24 equipment mounting screws separately.

Part Number	Description	Shipping Weight lb (kg)
BCE-24-P	1U 2-Port Enclosure	7 (3.2)
BCE-24-N	1U Non-Ported Enclosure	7 (3.2)



BCE-48-P

BCE-48-P/N

BCE-48-P/N measures 14"W x 6"D x 20"L (360 mm x 150 mm x 510 mm). It includes rotating threaded interior mounting brackets for 2U of 19"W patch panels. Order #12-24 equipment mounting screws separately.

Part Number	Description	Shipping Weight lb (kg)
BCE-48-P	2U 2-Port Enclosure	12 (5.4)
BCE-48-N	2U Non-Ported Enclosure	12 (5.4)

Service Parts

CPI provides a variety of replacement parts for zone cabling enclosures. Chrome Lock Kits and Spare Keys enhance security of the Ceiling Enclosure, replacing existing turn locks. Mounting Brackets ensure weight of Raised Floor Enclosure is fully supported.



Spare
Keys

Chrome
Lock Kit

Chrome Lock Kits/Spare Keys

Optional locks provide additional security for all standard ceiling enclosures. Includes two locks and two keys.

Part Number	Description
Chrome Lock Kit	Lock Kit, Pair
Spare Keys	Spare Keys, Pair



RF-BRACKET

Raised Floor Mounting Brackets

Additional brackets used to support Raised Floor Enclosures from access floor support pedestals.

Part Number	Description
RF-BRACKET	Mounting Brackets, 4 each



Wire Cage Enclosures

Wire Cage Enclosures create a security partition around your equipment in shared facility spaces such as Multitenant Data Centers (MTDC), colocation sites, entrance facilities and equipment rooms. Wire Cage Enclosures feature an open design made from a woven wire mesh that allows airflow to equipment, while providing physical security. CPI Wire Cage Enclosures are a simple, economical way to partition your space and secure your equipment.

Wire Cage Enclosures are comprised of several standard components including Modular Panels, Posts, Adjustable Panels, Doors and Door Locks. Each component is described below. Wire Cage Enclosures are available painted Black or Glacier White. Work with CPI Technical Support to create a unique solution, sized to match your specific site requirements.

Features:

- Easy configuration and ordering – Simply contact CPI Technical Support, and they will ask a series of questions about the size of the cage and preferred door size, style, location and lock. CPI will create a quote based on your described solution, and your order will ship as a complete kit under a single part number.
- Complete partitions and security for your space and equipment – Provides physical security for your cabinets and equipment. A variety of locks are available to secure cage doors, and a ceiling can be added if required.
- Easy integration into the existing site – The open 2" x 1" rectangular mesh design allows free circulation of air to support the existing cooling system, lighting design and the fire suppression system within the secured area.

- Strong, secure and durable construction – Support posts have welded base plates that allow direct floor anchoring. Panels bolt directly to support posts, utilizing the heaviest assembly hardware in the industry. All cage assembly hardware is inside the cage, so panels cannot be tampered with from the outside. Standard 3/8" wedge anchors hold partitions firmly in place.
- Modular design allows easy installation – The scalable, modular design allows the system to match site requirements. All components ship together as a complete kit. Posts and panels bolt together to form the cage. Self-drilling screws are used to attach doors. No cutting or grinding is required during installation. Assembly hardware is included and easily accessible from inside the frame.
- Matched finish for CPI Glacier White cabinets – Available in Glacier White finish to match your F-Series TeraFrame Gen 3 Cabinets, N-Series TeraFrame Gen 3 Network Cabinets and GF-Series GlobalFrame Gen 2 Cabinets in Glacier White.

Please contact CPI Technical Support for your Wire Cage Enclosure layout and pricing information. Simply email your layout information/drawing with the subject line "Wire Cage Enclosures" to techsupport@chatsworth.com, and include your contact information in the body of the email.

A CPI Representative will then contact you.

SECTION 2

RACKS & CABLE MANAGEMENT

Universal Rack	2-3
Standard Rack	2-6
Global Standard Pack	2-8
Velocity Standard Pack	2-9
SeismicFrame Two-Post Rack	2-10
Adjustable Rail Four-Post QR/SR	2-13
Adjustable QuadraRack & ServerRack	2-16
QuadraRack® Server Frame	2-20
Rack Accessories	2-23
Heavy-Duty Wall-Mount Equipment Rack	2-40
EasySwing® Wall-Mount Rack	2-41
Standard Swing Gate Wall Rack	2-42
Fixed Wall-Mount Equipment Rack	2-43
Wall-Mount Rack Accessories	2-44
Motive® Cable Manager	2-45
Evolution® Cable Manager	2-51
Velocity® Cable Manager	2-57
MCS Master Cabling Section	2-60
CCS Combination Cabling Section	2-61
Global Vertical Cabling Section	2-63
Vertical Cable Management	2-64
Universal Horizontal Cable Manager	2-68

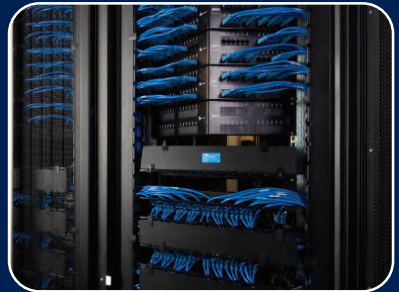

Learn about CPI's Standard Limited Warranty and Extended Limited Warranties.
See page vii for details.

RACKS & CABLE MANAGEMENT

CPI's relay-style frames are industry-leading and support equipment and cabling with unrivaled strength, stability and durability. Four-post racks provide the strength and stability of an independent cabinet in a cost-effective open solution.

Open wall-mount racks present easy access to cables and equipment and offer both fixed and swing frames. Swing frames pivot open on one side to provide access to the rear of equipment and are used to support patch panels, while fixed frames hold more weight and are used for network routers and switches.

Whether you update your current infrastructure or design a new installation, trust that CPI experts will deliver the most comprehensive cable management product line in the industry.

Where Can I Learn More?

To learn more about CPI's Rack Systems or Cable Management Products, and to find additional part numbers not listed in this catalog, please visit our website, chatsworth.com

Related Tools:

Use these tools, under the Resources tab on chatsworth.com, to simplify your planning, selection, order and purchase of CPI Rack Systems or Cable Management Products.

- Visio Shapes
- CAD Blocks
- BIM Drawings
- Cable Fill
- MasterFormat Specifications



HCAI-OPM-0261



Bonding Studs located directly on rack channel



U marks simplify equipment installation

Universal Rack

Features:

- High-strength, lightweight aluminum extrusion construction
- (2) top angles or top bars and heavy-duty assembly hardware for stronger rack to handle heavier loading
- 50 special #12-24 mounting screws with combination Phillips/Straight heads and pilot points to reduce cross threading and installation time
- Unique packaging inserts eliminate damage from components hitting together in the carton during shipping and handling; racks are packed unassembled in individual cartons
- Ease of assembly is enhanced through use of threaded channels; no hex nuts are required
- Universal 5/8" - 5/8" - 1/2" (15.9 mm - 15.9 mm - 12.7 mm) alternating hole pattern offers greater mounting flexibility, maximizes usable mounting space and is compatible with conventional width 1-1/4" - 1/2" (31.8 mm - 12.7 mm) alternating hole patterns
- Integrated masked bonding studs on the inside of the rack channel for quick attachment to the Telecommunications Bonding System
- Available in powder coat color finishes: Gray, Black, Glacier White or grained aluminum finish (Clear)
- State-of-the-art manufacturing methods provide the best quality and fastest delivery in the industry
- EIA-310 side channels have multiple mounting holes and (4) pem nuts for quick installation of cable management
- EIA Channels: C-Shaped, 1.265" x 3" (32.13 mm x 76 mm); .25" (6.4 mm) thick front/rear flanges; .17" (4.3 mm) thick web (pair)
- Base Angles: 3.5" x 6.0" x .375" (89 mm x 152 mm x 9.53 mm) thick (pair)
- Top Angles: 1.5" x 1.5" x .25" (38 mm x 38 mm x 6.4 mm) thick (pair)
- Top Angles, Flush Bolted: 1.5" x 2.0" x .25 (38 mm x 51 mm x 6.4 mm) thick
- Top Bars: 1.5" x .25" (38 mm x 6.4 mm) thick (pair)
- Panel Mounting Holes: #12-24 rolled threads in both flanges front and back
- Custom configurations and assemblies available by special order
- Assembly hardware is included
- Select models (P/N 48353-XXX, 48383-XXX) are UL Listed: File E140851; Category DUXR (US), DUXR7 (Canada) – Communications Circuit Accessory
- Weight capacity 1500 lb (680.4 kg) — weight must be evenly distributed, and rack must be properly secured to floor

Installation Hint: When mounting equipment, use #3 Phillips tip to assure maximum torque.

Channel Cross Section and Hole Pattern Standards

CPI offers EIA aluminum channel uprights on all Standard and Universal racks. All Standard and Universal racks are threaded to accept industry standard #12-24 mounting screws. Extra care is taken in that the threads are "rolled" rather than "cut" for greater strength and durability. The Universal Rack hole pattern is 5/8"-5/8"-1/2" (15.9 mm-15.9 mm-12.7 mm) and is compatible with wide 1 1/4"-1/2" (31.8 mm-12.7 mm) patterns, while offering greater flexibility.

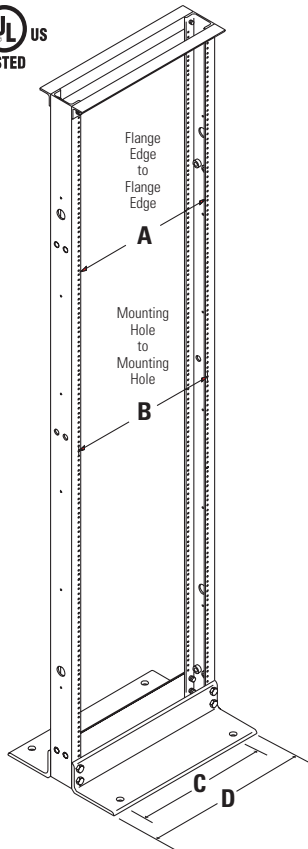

Universal Rack Ordering Matrix

- UL Listed racks offered in multiple heights and 19" or 23" widths
- For heavy-duty, high-capacity installations.

Top Bar or Angles	
460	Two Top Bars
463	Two Top Angles
467	Two Top Angles, Flush Bolted
483	UL Listed (With Two Top Angles)

Width - in	
5	19 EIA Channel
8	23 Channel

Mounting Holes	
3	Mounting Holes Both Sides

Color	
1	Gray
5	Clear
7	Black
E	Glacier White

Height		
31	3 (0.9)	17U
20	4 (1.2)	24U
19	5 (1.5)	31U
00	5.6 (1.7)	34U
01	6 (1.8)	38U
02	6.6 (2.0)	41U
03	7 (2.1)	45U
05	7.6 (2.3)	48U
15	8 (2.4)	51U
17	8.6 (2.6)	55U
08	9 (2.7)	58U

4XX X X - X XX

Dimension	19" EIA Rack in (mm)	23" EIA Rack in (mm)
A	17.75 (450.9)	21.75 (552.5)
B	18.31 (465.1)	22.31 (566.7)
C	16 (410.0)	20 (510.0)
D	20.31 (515.9)	24.31 (617.5)

Shipping Weights - lb (kg)	
6' (1.8 m) Rack	37 (16.8)
7' (2.1 m) Rack	39 (17.7)
8' (2.4 m) Rack	41 (18.6)

Top View of Base Angle

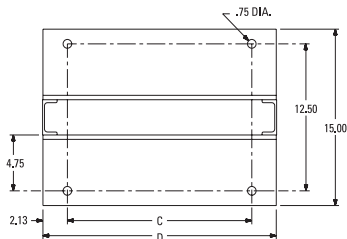

Dimensions:

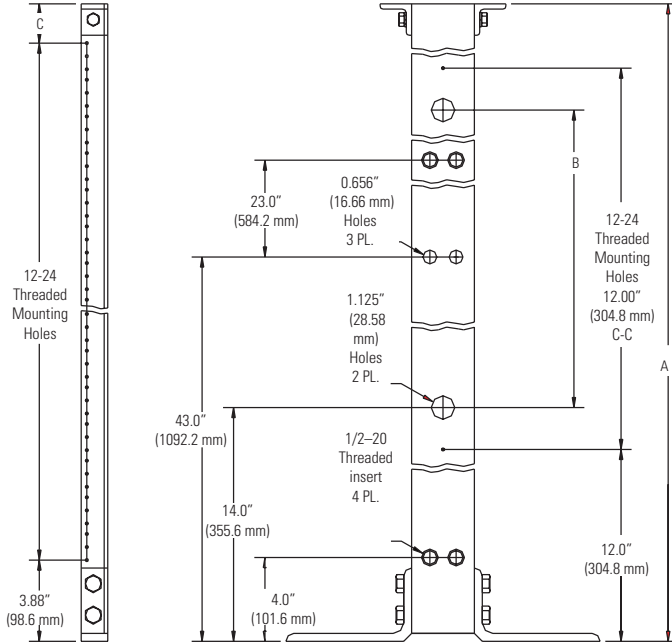

Front and Rear Flanges
(both sides drilled)

Web Surface
7' (2.1 m) Universal Rack

Rack Height Dimension A ft (m)	Dimension B in (mm)	Dimension C in (mm)	Number of Mounting Holes	Number of Mounting Spaces
3 (0.9)	N/A	1.75 (44.5)	53	17
4 (1.2)	N/A	2.13 (54.1)	72	24
5 (1.5)	43 (1090)	1.88 (47.8)	94	31
5.6 (1.7)	44 (1120)	2.00 (50.8)	104	34
6 (1.8)	56 (1420)	2.12 (53.8)	114	38
6.6 (2.0)	56 (1420)	1.75 (44.5)	125	41
7 (2.1)	56 (1420)	1.87 (47.5)	135	45
7.6 (2.3)	56 (1420)	2.62 (66.5)	144	48
8 (2.4)	72 (1830)	2.25 (57.2)	155	51
8.6 (2.6)	72 (1830)	2.38 (60.5)	165	55
9 (2.7)	72 (1830)	2.00 (50.8)	176	58

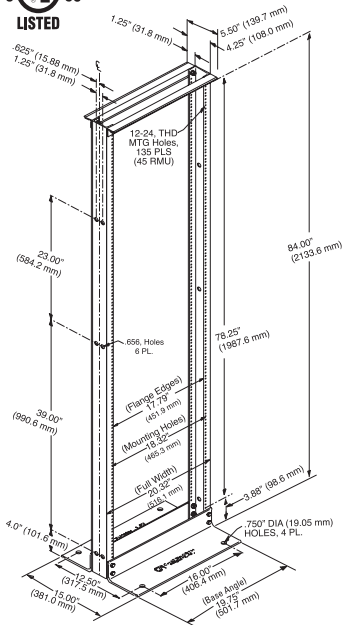

Standard Rack 3”D (80 mm)

The Standard Rack is designed for value conscious, high-volume customers, who require the quality and service that sets CPI racks apart from the competition. The Standard Rack is a UL Listed communication circuit accessory, designed specifically for use in telecommunications equipment installations where codes require UL Listed equipment racks. For a greater breadth of features, we recommend CPI Universal Racks.

- High-strength aluminum construction
- Shipped with (2) top angles, (2) base angles, (2) 3”D (80 mm) equipment channels and installation hardware
- Top angles allow J-bolt attachment without interfering with top U
- EIA-310 Standard Universal 5/8” - 5/8” - 1/2” (15.9 mm - 15.9 mm - 12.7 mm) alternating hole pattern offers greater mounting flexibility and is fully compatible with conventional wide 1-1/4” - 1/2” (31.8 mm - 12.7 mm) alternating hole patterns
- (6) web channel holes per side enable multiple racks to be mounted together side by side or attachment of cable managers
- Integrated masked bonding studs on the inside of the rack channel for quick attachment to the Telecommunications Bonding System
- High-strength roll-formed threaded mounting holes
- Rack space U marks simplify equipment installation
- Includes 50 pilot point #12-24 mounting screws with combination Phillips/Straight heads to reduce cross-threading and installation time
- Available in powder coat color finishes: Gray, Black, Glacier White or grained aluminum finish (Clear)
- Ships unassembled, individually packaged, with assembly hardware and installation instructions; bulk packaging is also available
- Redesigned shipping container saves space and freight costs
- Choose from (3) heights
- Weight capacity of 1000 lb (453.6 kg) — weight must be evenly distributed, and rack must be properly secured to the floor
- UL Listed; File E140851; Category DUXR (US), DUXR7 (Canada) – Communications Circuit Accessory

HCAI-OPM-0261



Bonding Studs located directly on rack channel



U marks simplify equipment installation

Part Number	Description H x W Height - ft (m)	Shipping Weight lb (kg)
55053-X03	7 (2.1) x 19", 45U	31 (14.1)
55053-X15	8 (2.4) x 19", 52U	37 (16.8)
55053-X08	9 (2.7) x 19", 58U	40 (18.1)

X=color: 1=Gray, 5=Clear, 7=Black, E=Glacier White

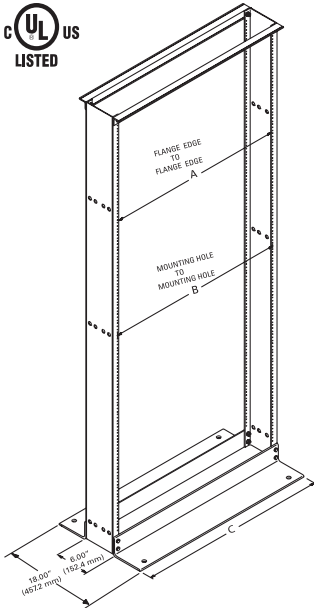

P/N 66363 (35" W) Shown:
 The 6" D (150 mm) Standard Rack is the high-capacity frame that is designed for use with cabling sections and is the basic frame around which the XLBET/MDF frames are developed.

HCAI-OPM-0261

Standard Rack 6" D (150 mm)

Features 6" D (150 mm) upright mounting channels for MDF, IDF and other high-capacity distribution frame applications. The additional rack depth provides extra room for high-density equipment and cable needs.

- High-strength aluminum construction
- Supplied with (2) top angles for additional strength
- EIA-310 Standard Universal 5/8" - 5/8" - 1/2" (15.9 mm - 15.9 mm - 12.7 mm) alternating hole pattern offers greater mounting flexibility and is fully compatible with conventional wide 1-1/4" - 1/2" (31.8 mm - 12.7 mm) alternating hole patterns
- Rack space U marks simplify equipment installation
- High-strength, roll-formed threaded mounting holes
- Ships unassembled and individually packaged
- Integrated masked bonding studs on the inside of the rack channel for quick attachment to the Telecommunications Bonding System
- Includes assembly hardware and (50) pilot point #12-24 mounting screws with combination Phillips/Straight heads
- Weight capacity 1000 lb (453.6 kg) — weight must be evenly distributed and rack must be properly secured to the floor
- UL Listed; File E140851; Category DUXR (US), DUXR7 (Canada) – Communications Circuit Accessory

Part Number	Description H x W Height - ft (m)	Shipping Weight lb (kg)
66353-X03	7 (2.1) x 19", 45U	38 (17.2)
66383-X03	7 (2.1) x 23", 45U	42 (19.1)
66363-X03	7 (2.1) x 35", 45U	52 (23.6)

X=color: 1=Gray, 5=Clear, 7=Black, E=Glacier White

Rack Dimensions			
Dimension	19" EIA Rack in (mm)	23" EIA Rack in (mm)	35" EIA Rack in (mm)
A	17.79 (451.9)	21.79 (553.5)	33.79 (858.3)
B	18.31 (465.1)	22.31 (566.7)	34.31 (871.5)
C	20.31 (515.9)	24.31 (617.5)	36.31 (922.3)

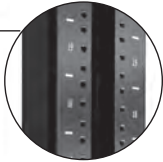
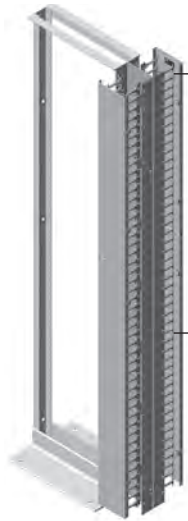

Standard Rack with U printed on rack

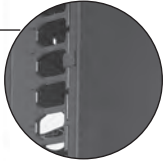

Fingers align with U on rack

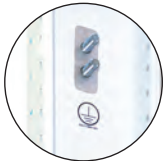

Integrated masked ground studs

Global Standard Pack

The Global Standard Pack shown has two Global Vertical Cabling Sections used back-to-back on the same side of the rack to create a double-sided cable manager. Cabling sections can also be mounted on opposite sides of the rack to create two single-sided cable pathways.

- Numbered rack-mount unit (U) spaces on the rack are printed on the equipment mounting channels, providing the installer an easy way of positioning equipment in planned spaces
- Cable openings in Global Vertical Cabling Section align with U spaces on the rack, allowing cables to exit by the U
- Integrated masked bonding studs on the inside of the rack channel for quick attachment to the Telecommunications Bonding System
- Cable openings have rounded edges to protect cable and will not deform or break
- Door/cover snaps on and opens to the right or left for easy access to cables during moves, adds or changes
- Global Standard Pack is UL Listed as a communication circuit accessory
- Rack installation kit for concrete floor

Part Number	Description Width in (mm)	Shipping Weight lb (kg)
57001-X03	(1) Standard Rack, 45U x 19" EIA, UL (1) GVCS Single-Sided Vertical Cable Manager, 3.65"W (92.7 mm) (1) Rack Installation Kit for concrete floor, 1/2" hardware, Zinc	50 (22.7)
57002-X03	(1) Standard Rack, 45U x 19" EIA, UL (2) GVCS Single-Sided Vertical Cable Managers, 3.65"W (92.7 mm) (1) Rack Installation Kit for concrete floor, 1/2" hardware, Zinc	65 (29.5)
57003-X03	(1) Standard Rack, 45U x 19" EIA, UL (1) GVCS Single-Sided Vertical Cable Manager, 6"W (150 mm) (1) Rack Installation Kit for concrete floor, 1/2" hardware, Zinc	52 (23.6)
57004-X03	(1) Standard Rack, 45U x 19" EIA, UL (2) GVCS Single-Sided Vertical Cable Managers, 6"W (150 mm) (1) Rack Installation Kit for concrete floor, 1/2" hardware, Zinc	67 (30.4)

X=Color: 5=Clear, 7=Black, E=Glacier White. Clear (-5XX) versions include GVCS with black doors/covers and cable guides. GVCS is 6.76"D (171.7 mm).



Combines a 7"H x 19"W x 3"D (2.1m x 19" W x 80 mm) Standard Rack, Global Vertical Cabling Sections and Concrete Floor Installation Kit into one convenient shipping container.



Rack-Mount Unit (U) marks simplify equipment installation



Ground Studs located directly on rack channel



Side cable openings align with U marks on the rack

Velocity Standard Pack

The Velocity Standard Pack is an easy-to-use solution for managing equipment and cabling at the cross connect. The Velocity Standard Pack is offered in four variations, with a single-sided or double-sided cable manager in either 3.6"W (91 mm) or 6"W (152 mm). Cable managers can be mounted on either side of the standard rack.

- Numbered rack-mount spaces on the Standard Rack are printed on the equipment mounting channels, providing the installer an easy way of positioning equipment in planned spaces
- Cable openings in Velocity Vertical Cable Managers align with rack-mount units on the rack, allowing cables to exit by rack-mount units
- Integrated masked bonding studs on the inside of the rack channel for quick attachment to the Telecommunications Bonding System
- Cable openings have rounded edges to protect cable and will not deform or break
- Cover snaps on and opens to the right or left for easy access to cables during moves, adds or changes

Velocity Standard Pack includes:

- (1) 45U x 19" Standard Rack
- (1) Single or double-sided Velocity vertical cable manager
- (1) Rack installation kit for concrete floors

Part Number	Description Width in (mm)	Shipping Weight lb (kg)
57011-703	(1) Standard Rack, 45U x 19"EIA, UL, Black; (1) Velocity Single-Sided Vertical Cable Manager, 3.6"W (91 mm), Black; (1) Rack Installation Kit for concrete floor, 1/2" hardware, Zinc	47 (21.3)
57012-703	(1) Standard Rack, 45U x 19"EIA, UL, Black; (1) Velocity Double-Sided Vertical Cable Manager, 3.6"W (91 mm), Black; (1) Rack Installation Kit for concrete floor, 1/2" hardware, Zinc	60 (27.2)
57013-703	(1) Standard Rack, 45U x 19"EIA, UL, Black; (1) Velocity Single-Sided Vertical Cable Manager, 6"W (152 mm), Black; (1) Rack Installation Kit for concrete floor, 1/2" hardware, Zinc	50 (22.7)
57014-703	(1) Standard Rack, 45U x 19"EIA, UL, Black; (1) Velocity Double-Sided Vertical Cable Manager, 6"W (152mm), Black; (1) Rack Installation Kit for concrete floor, 1/2" hardware, Zinc	68 (30.8)



PATENTED



SeismicFrame Two-Post Rack

- Welded, steel network equipment rack engineered specifically to protect equipment in areas with seismic activity
- Available in two sizes: 24"W (610 mm) or 28"W (710 mm)
- Vertical Powers Strips and T-shaped Cable Management Fingers attach directly to the rack channel to provide power and cable distribution for equipment
- 19"W Rack fits within a 24" (610 mm) access floor tile
- Fully bonded rack has (2) masked bonding locations and includes a Two Mounting Hole Bonding Terminal Block for easy connection to the Secondary Bonding Busbar (SBB)
- Independently seismic-tested and certified, meets industry recognized Telecordia Technologies, Inc. GR-63-CORE Network Equipment Building Systems (NEBS) Zone 4 requirements
- EIA-310 Compliant
- UL Listed NWIN per UL60950, File E227626
- 1000 lb (453.6 kg) load rating for seismic areas

Includes:

- (1) welded, steel frame
- (4) equipment mounting rails
- (50) each equipment mounting screws/cage nuts
- (4) each Anchor Washers
- (1) Two Mounting Hole Bonding Terminal Block

HCAI-OPM-0249

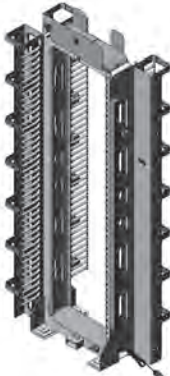

SeismicFrame Two-Post Rack populated with available accessories



Adjustable Depth Mounting Rails



Two Mounting Hole Bonding Terminal Block

PATENTED

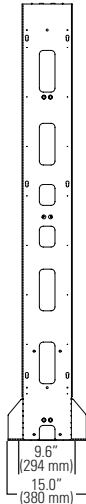
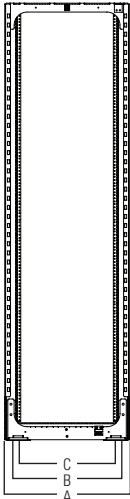

Description	19 in (mm)	23 in (mm)
Overall Width (A)	24.0 (610)	28.0 (710)
Frame Opening (B)	19.3 (490)	23.3 (592)
Rail Clearance (C)	17.75 (450)	21.75 (552)

SeismicFrame Two-Post Rack

Open, two-post, seismic rack supports 19" W EIA or 23" W rack-mount equipment.

Part Number	Description H x W ft (m)	Shipping Weight lb (kg)
13853-X03	7 (2.1) x 19", 44U Tapped #12-24 Zinc Rails	180 (81.6)
13854-X03	7 (2.1) x 19", 44U Square-Punched Zinc Rails	178 (80.7)
13855-X03	7 (2.1) x 19", 44U Tapped #12-24 Painted Rails	180 (81.6)
13856-X03	7 (2.1) x 19", 44U Square-Punched Painted Rails	178 (80.7)
13883-X03	7 (2.1) x 23", 44U Tapped #12-24 Zinc Rails	185 (83.9)
13884-X03	7 (2.1) x 23", 44U Square-Punched Zinc Rails	183 (83.0)
13885-X03	7 (2.1) x 23", 44U Tapped #12-24 Painted Rails	185 (83.9)
13886-X03	7 (2.1) x 23", 44U Square-Punched Painted Rails	183 (83.0)

Notes: X=Color; 1=Gray, 7=Black.

Install using (4) seismic-rated concrete anchors (sold separately).

Cable Management:

- The top of the rack is punched with attachment points for the CPI Top-Mount Cable Waterfall Tray and Cable Runway
- Attach 9" W (230 mm), 12" W (300 mm), 15" W (380 mm) and 18" W (460 mm) Cable Runway to racks in perpendicular (front-to-back) orientation with the Cable Runway J-Bolt Kit; 23" W racks will also support 20" W (510 mm) Cable Runway
- Attach 12" W (300 mm) to 24" W (610 mm) Cable Runway in parallel (side-to-side) orientation with the 3" W (80 mm) Channel Rack-To-Runway Mounting Plate.
- The front of the rack is punched with attachment points for the CPI Cable Management Fingers Kits
- The sides of the rack are punched with three pairs of centered, 1/2-20 threaded attachment points for CPI SeismicFrame Two-Post Rack Vertical Cabling Section
- Attach a CPI Single-Sided Wide Vertical Cabling Section to the side of the rack with the CPI Vertical Cabling Section Offset Mounting Bracket Kit
- Evolution® Cable Management and MCS-EFX Master Cabling Section with Extended Fingers will also attach to the side of the rack
- Velocity® Cable Management will not attach to the side of the rack Shelves:
- Use CPI Heavy Duty Equipment Shelf for 6" (150 mm) Channel with the rack's mounting rails set 6" (150 mm) apart
- When rails are set 3" W (80 mm) apart, the maximum shelf width on 19" W racks is 19.3" W (490 mm) and the maximum shelf width on 23" W racks is 23.3" W (592 mm)

7U



Cable Management Fingers Kit

Organize patch cords and jumper cables by U space.

- 7U T-shaped plastic cable guides snap onto the front and rear of the rack frame
- Openings between the T-shaped guides align with each U space on the rack
- Single-Sided Kit includes 12 cable guides for one side (front or rear) of the rack
- Double-Sided Kit includes 24 cable guides for both sides (front and rear) of the rack

Part Number	Description	Shipping Weight lb (kg)
13696-001	Fingers Kit, Single-Sided, Black	7 (3.2)
13696-002	Fingers Kit, Double-Sided, Black	14 (6.4)

Color is Black.



13697-001

SeismicFrame Two-Post Rack Accessories

Vertical Power Strip Mounting Kit

Includes mounting hardware that allows two CPI Vertical Power Strips to attach to the keyholes on the sides of the SeismicFrame Two-Post Rack or the back of the Vertical Cabling Section listed above. Cannot be used on the same side as the Vertical Cabling Section or Cable Management Fingers Kit.

Duplex Electrical Outlet Box

Provides a location for a power connection at the base of the rack. Includes a single-gang box for a single duplex receptacle and two self-tapping Torx head T25 installation screws. Outlet box is welded steel, 3-3/4" H x 1-13/16" W x 2-1/2" D (95 mm x 46 mm x 64 mm) with a 15.5 in³ (250 cm³) wiring capacity, has eight (four accessible) concentric knockouts for 1/2" or 3/4" conduit and is zinc galvanized for corrosion protection. UL Listed.

Part Number	Description	Shipping Weight lb (kg)
13697-001	Vertical Power Strip Mounting Kit	1 (0.5)
13698-001	Duplex Electrical Outlet Box, Zinc	1 (0.5)
13697-X01	Vertical Power Strip Mounting Kit, Clear	1 (0.5)

X=Color; 1=Gray, 7=Black, E=Glacier White



13698-001



Adjustable Rail QuadraRack (ARQR) and Adjustable Rail ServerRack (ARSR)

The Adjustable Rail QuadraRack® (ARQR) and the Adjustable Rail ServerRack (ARSR) provide a sturdy, feature-rich solution for supporting rack-mount network, computer server and data storage equipment in data centers, computer equipment rooms and other IT facilities. Both racks offer the strength and stability of an enclosure in an open four-post mounting system that provides easy access to equipment and cabling.

The front and rear frames are welded to speed up assembly and increase strength. Four brackets connect the front and rear corners of the frames. Front mounting rails attach to the front frame in a fixed position and align with the front of the rack or can be reversed for recessed mounting to maximize side-to-side airflow through network switches. Rear mounting rails are adjustable in depth and can extend beyond the rear of the frame. A second set of holes along the sides of the frame lets you add optional side-mounted equipment support rails and vertical power strips that are independent of the mounting rails and use no U. The bottom of the rack is punched for easy floor attachment.

Each rack includes a Top-Mount Cable Waterfall Tray with adjustable radius drops to allow easy side-to-side routing for patch cords. Use with any CPI cabling section (vertical cable manager) or Cable Guide Kits to organize cables along the sides of the rack. Attach CPI Cable Runway to the top of the rack with J-Bolts, a Cable Runway Elevation Kit or a Cable Runway Mounting Bracket to support overhead premise cables. A side panel is also available.

Features:

- Available in three heights and two depths
- Adjustable Rail QuadraRack (ARQR) has threaded mounting holes that speed up installation of patch panels, fiber enclosures and network switches.
- Adjustable Rail ServerRack (ARSR) has square-punched mounting rails that allow you to change mounting hardware (Clik-Nut® or cage nuts) to match specific computer server and data storage equipment mounting requirements
- Each U is marked and numbered
- Front pair of mounting rails may be mounted to allow U numbering to start at the top or bottom of the rack
- Rear mounting rail adjusts in depth
- UL Listed; File E227626; Category NWIN (US), NWIN7 (Canada) – Information Technology and Communications Equipment Cabinet, Enclosure and Rack
- Each rack will support up to 2200 lb (1000.0 kg) of equipment

Includes:

- (2) mounting frames
- (4) horizontal braces
- (2) front mounting rails
- (2) rear mounting rails
- (1) top-mount cable tray
- Assembly hardware: (1) Two Mounting Hole Bonding Terminal Block and Antioxidant Joint Compound
- ARSR includes (50) #12-24 cage nuts and screws
- ARQR includes (50) #12-24 screws



Mounting Rails can be flipped to change numbering from bottom-to-top or top-to-bottom

Adjustable Rail 4-Post Rack Ordering Matrix

- UL Listed racks offered in multiple heights and 19" or 23" widths
- For heavy-duty, high-capacity installations

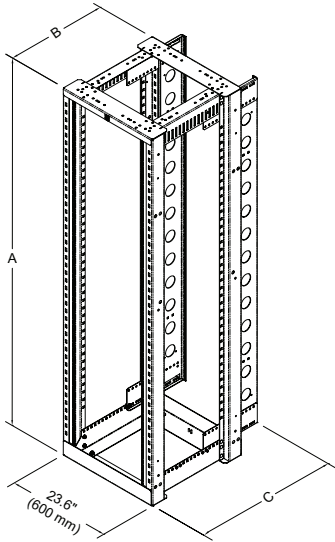

Adjustable Rail QuadraRack® and Adjustable Rail ServerRack	
1525	19" Adjustable Rail 4-Post Racks

	Mounting Hole Style	Rack Depth (B) in (mm)	Max. Rail Depth (C) in (mm)
1	#12-24 Threaded	23.62 (600)	29.52 (750)
2	#12-24 Threaded	35.43 (900)	41.33 (1050)
3	Square-Punched	23.62 (600)	29.52 (750)
4	Square-Punched	35.43 (900)	41.33 (1050)

Note: Min. Rail Depth is 15" (380 mm).

Color	
1	Gray
7	Black
E	Glacier White

Height (A)		
U	Height - in (mm)	
01	38	72 (1800)
03	45	84 (2100)
15	51	96 (2400)

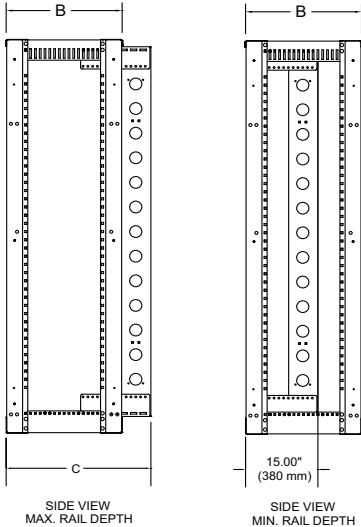

1525	X	-	X	XX
------	---	---	---	----

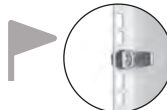

CliK-Nut® cage nuts make installation time quick and easy. Go to page 2-20 for ordering information.

PATENTED



15285-X01



15275-X01



15286-001



15270-X01

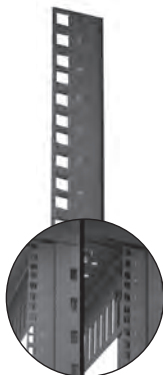

15260-X01

Mounting Rails can be flipped to change numbering from bottom-to-top or top-to-bottom

Adjustable Rail 4-Post Rack Accessories

Equipment Support Rail

Attaches to the side of the Adjustable Rail QuadraRack or ServerRack and provides a .98"W (25 mm) support surface for equipment. Does not interfere with U spaces. Supports 200 lb (90.7 kg) of equipment and includes hardware.

Top-Mount Cable Waterfall Tray

One Top-Mount Cable Waterfall Tray is included with each rack to guide patch cords side-to-side or rack-to-rack. 6"W x 5.2"D (152 mm x 132 mm) steel tray.

Cable Guide Kit

T-shaped cable guides (7U) snap-on to the front or rear of the rack to organize cables. The openings align with each U space on the rack.

Side Panel

Solid, steel side panel used to cover the end of the rack and/or vertical cable managers at the end of a row. Matches the height and depth of rack, steel.

Fixed Equipment Mounting Rail

Additional pair of equipment mounting rails to create a solution with two mounting depths set between 15"D (381 mm) and the rack depth. Includes installation hardware.

Part Number	Description H x W Height - ft (m)	Shipping Weight lb (kg)
15285-X01	Equipment Rail, for 23.62" (600 mm) Racks	7 (3.2)
15285-X02	Equipment Rail, for 35.43" (900 mm) Racks	11 (5.0)
15275-X01	Top-Mount Cable Waterfall Tray	14 (6.4)
15286-X01	Cable Guide, for 38U Racks, Black	5 (2.3)
15286-X03	Cable Guide, for 45U Racks, Black	6 (2.7)
15286-X15	Cable Guide, for 51U Racks, Black	7 (3.2)
15270-X01	Side Panel, 23.62"D x 72"H	51 (23.1)
15270-X02	Side Panel, 23.62"D x 84"H	57 (25.9)
15270-X03	Side Panel, 23.62"D x 96"H	48 (21.8)
15270-X04	Side Panel, 35.43"D x 72"H	63 (28.6)
15270-X05	Side Panel, 35.43"D x 84"H	71 (32.2)
15270-X06	Side Panel, 35.43"D x 96"H	60 (27.2)
15259-X01	Fixed Rail, Threaded, for 38U Racks	20 (9.1)
15259-X03	Fixed Rail, Threaded, for 45U Racks	23 (10.4)
15259-X15	Fixed Rail, Threaded, for 51U Racks	26 (11.8)
15260-X01	Fixed Rail, Square-Punched, for 38U Racks	19 (8.6)
15260-X03	Fixed Rail, Square-Punched, for 45U Racks	22 (10.0)
15260-X15	Fixed Rail, Square-Punched, for 51U Racks	25 (11.3)

X=Color, 1=Gray, 7=Black, E=Glacier White



HCAI-OPM-0302

Adjustable QuadraRack (AQR) and ServerRack (ASR)

The Adjustable QuadraRack and the Adjustable ServerRack provide a sturdy, cost-effective solution for supporting rack-mount network, computer server and data storage equipment in data centers, computer equipment rooms and other IT facilities. Both racks offer the strength and stability of an enclosure in an open four-post frame that provides easy access to equipment and cabling.

Each rack will support up to 2000 lb (907.2 kg) of equipment. The corner posts are C-shaped equipment mounting channels that provide front and rear support for 19" W rack-mount equipment or shelves. The front and rear frames are welded to reduce assembly time. Four brackets connect the front and rear corners of the rack. The rack is available in four heights and four depth ranges. The front-to-rear depth of the mounting channels can be adjusted up to 5.91" (150 mm) in depth in .98" (25 mm) increments during assembly. The mounting channels are fixed in place once assembled to surround and protect equipment.

The Adjustable QuadraRack has threaded mounting holes that make installation time of patch panels, fiber enclosures and network switches shorter. Adjustable ServerRack has square-punched holes that let you change mounting hardware (Clik-Nuts or cage nuts) to match specific computer server and data storage equipment mounting requirements. Each U is marked on the channels, making it easy to locate and position equipment. A second set of holes along the sides of the channels lets you add optional side-mounted Equipment Support Rails that use no additional U.

Features:

- Open design for unrestricted airflow and easy access to equipment and cabling
- Self-squaring assembly with welded front and rear frames reduces assembly time
- Mounting channels adjust in depth to provide front and rear support for equipment
- Maximizes floor space with a minimal rack footprint
- Rack components are bonded together during assembly
- Includes a Two Mounting Hole Bonding Terminal Block for easy attachment to the Secondary Bonding Busbar (SBB)
- Choose square-punched or threaded equipment mounting holes
- U spaces are marked on the mounting channels
- Easy to bay together to create multi-rack configurations
- Use with any CPI Cabling Section to manage cables
- Support large equipment on heavy-duty shelves or on side-mounted Equipment Support Rails
- UL Listed; File E227626; Category NWIN (US), NWIN7 (Canada) – Information Technology and Communications Equipment Cabinet, Enclosure and Rack
- Supports 2000 lb (907.2 kg) of equipment



Self-squaring
assembly

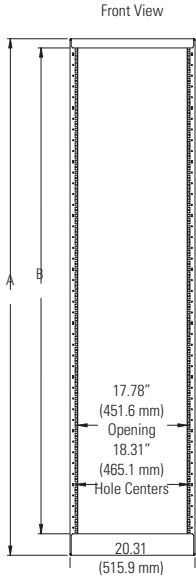

Side View

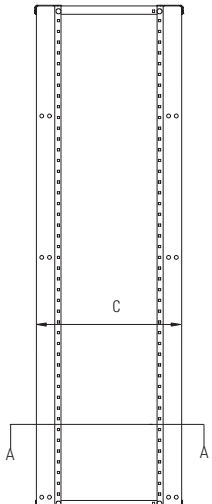

Adjustable 4-Post Rack Ordering Matrix

Adjustable QuadraRack® and ServerRack, 19"	
1521	19" Adjustable 4-Post Racks

	Mounting Hole Style	Mounting Channel Depth Range (C) in (mm)
1	Square-Punched	15.75 to 21.65 (400 to 550)
2	Square-Punched	22.64 to 28.54 (575 to 725)
3	Square-Punched	29.53 to 35.43 (750 to 900)
4	Square-Punched	36.42 to 42.32 (925 to 1075)
5	#12-24 Threaded	15.75 to 21.65 (400 to 550)
6	#12-24 Threaded	22.64 to 28.54 (575 to 725)
7	#12-24 Threaded	29.53 to 35.43 (750 to 900)
8	#12-24 Threaded	36.42 to 42.32 (925 to 1075)

Color	
1	Gray
7	Black
E	Glacier White

Height (A)			
	U	(A) - in (mm)	(B) - in (mm)
01	38	72 (1800)	67 (1700)
03	45	84 (2100)	79 (2000)
15	51	96 (2400)	91 (2300)
08	58	108 (2740)	103 (2620)

1521	X	-	X	XX
------	---	---	---	----

Note: Mounting channel depth adjusts in .98" (25 mm) increments during assembly. The mounting depth is fixed once the rack is assembled. See the table on next page for a list of mounting channel depth settings by part number.

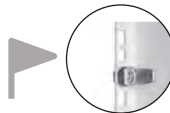
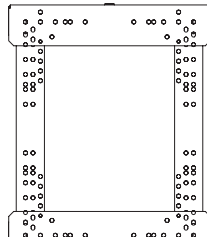

PATENTED

Clik-Nut® cage nuts make installation time quick and easy. Go to page 2-20 for ordering information.

ADJUSTABLE 4-POST RACK

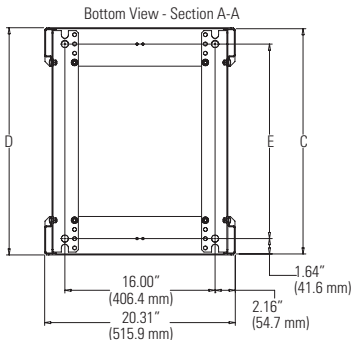

Notes:

1. There are seven depth settings for each part number as listed in the table.
2. Each rack adjusts front-to-rear in depth up to 5.91" (150 mm) in .98" (25 mm) increments.
3. Rack mounting channel depth is fixed once assembled.
4. Overall Depth (D) is Channel Depth (C) + 21" (53.3 mm).
5. Floor Mounting Holes (E) are Channel Depth (C) - 3.28" (83.3 mm).

Mounting Channel Depth Settings and Dimensions by Part Number							
Part Numbers		Channel Depth (C)		Overall Depth (D)		Floor Mounting Holes (E)	
		in	mm	in	mm	in	mm
15215-XXX	15211-XXX	15.75	400	15.96	405.4	12.47	316.7
		16.73	425	16.94	430.3	13.45	341.6
		17.72	450	17.93	455.4	14.44	366.8
		18.70	475	18.91	480.3	15.42	391.7
		19.69	500	19.90	505.5	16.41	416.8
		20.67	525	20.88	530.4	17.39	441.7
		21.65	550	21.86	555.2	18.37	466.6
15216-XXX	15212-XXX	22.64	575	22.85	580.4	19.36	491.7
		23.62	600	23.83	605.3	20.34	516.6
		24.61	625	24.82	630.4	21.33	541.8
		25.59	650	25.80	655.3	22.31	566.7
		26.57	675	26.78	680.2	23.29	591.6
		27.56	700	27.77	705.4	24.28	616.7
		28.54	725	28.75	730.3	25.26	641.6
15217-XXX	15213-XXX	29.53	750	29.74	755.4	26.25	666.8
		30.51	775	30.72	780.3	27.23	691.6
		31.50	800	31.71	805.4	28.22	716.8
		32.48	825	32.69	830.3	29.2	741.7
		33.46	850	33.67	855.2	30.18	766.6
		34.45	875	34.66	880.4	31.17	791.7
		35.43	900	35.64	905.3	32.15	816.6
15218-XXX	15214-XXX	36.42	925	36.63	930.4	33.14	841.8
		37.40	950	37.61	955.3	34.12	866.6
		38.39	975	38.60	980.4	35.11	891.8
		39.37	1000	39.58	1005	36.09	916.7
		40.35	1025	40.56	1030	37.07	941.6
		41.34	1050	41.55	1055	38.06	966.7
		42.32	1075	42.53	1080	39.04	991.6

Solid and Vented Shelves

1U x 19"W steel, shelf with adjustable depth rear mounting brackets; 17.68"W (449.1 mm). Supports 200 lb (90.7 kg) of equipment; includes assembly hardware.



15245-X01



15255-X01

Part Number	Shelf Depth in (mm)	Mounting Channel Depth in (mm)	Shipping Weight lb (kg)
Solid Shelves			
15245-X01	13.84 (351.5)	15.75 to 21.65 (400 to 550)	10 (4.5)
15245-X02	20.73 (526.5)	22.64 to 28.54 (575 to 725)	12 (5.4)
15245-X03	27.62 (701.6)	29.53 to 35.43 (750 to 900)	15 (6.8)
15245-X04	34.51 (876.6)	36.42 to 42.32 (925 to 1075)	18 (8.2)
Vented Shelves			
15255-X01	13.84 (351.5)	15.75 to 21.65 (400 to 550)	10 (4.5)
15255-X02	20.73 (526.5)	22.64 to 28.54 (575 to 725)	12 (5.4)
15255-X03	27.62 (701.6)	29.53 to 35.43 (750 to 900)	15 (6.8)
15255-X04	34.51 (876.6)	36.42 to 42.32 (925 to 1075)	18 (8.2)

X=Color; 1=Gray, 7=Black, E=Glacier White



15235-X01



12700-X19



15205-X01



15330-X01



15335-X01

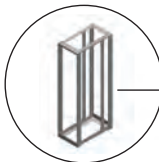

Adjustable 4-Post Rack Accessories

Equipment Support Rail

Additional support for heavy rack-mount equipment. Attaches to the side of rack and provides a 1.5"W (38 mm) front-to-rear support surface for equipment. Supports 200 lb (90.7 kg) of equipment; includes hardware.

Extra Heavy Duty Sliding Shelf

This 2U x 19"W sliding shelf with adjustable depth rear mounting brackets attaches to rack channels set 20.62"W to 32.48"D (525 to 825 mm). Solid surface is 15.5"W x 26"D (393.7 mm x 660 mm), extends 24" (609 mm) and locks in the open and closed positions. Supports 300 lb (136 kg) of equipment

Cable Runway Mounting Bracket

Aligns with the front, rear or side of the rack and supports 6"W to 24"W (150 mm to 600 mm) CPI Cable Runway. S-shaped, steel bracket measures 1.0"H x 3.3"W x 24.4"L (25 mm x 84 mm x 620 mm) and includes mounting hardware.

Center Rail

Attach the rails at any point along the side of the rack for adjustable depth. Marked and numbered U spaces simplify equipment installation. Maximum mount depth is 6" (152 mm) less than the channel depth of the rack. 1000 lb (453.6) equipment load bearing capacity when used as an independent pair or rails; rack load remains 2000 lb (907.2) when Center Rail is used as the front or rear pair of four-point mounting solution.

Part Number	Description H x W Height - ft (m)	Shipping Weight lb (kg)
15235-X01	Equipment Rail, 15.75 to 19.69 (400 to 500) D	5 (2.3)
15235-X02	Equipment Rail, 20.67 to 24.61 (525 to 625) D	6 (2.7)
15235-X03	Equipment Rail, 25.59 to 29.53 (650 to 750) D	7 (3.2)
15235-X04	Equipment Rail, 30.51 to 34.45 (775 to 875) D	9 (4.1)
15235-X05	Equipment Rail, 35.43 to 39.37 (900 to 1000) D	10 (4.5)
15235-X06	Equipment Rail, 40.35 to 44.29 (1025 to 1125) D	12 (5.4)
12700-X19*	Extra Heavy Duty Sliding Shelf, 19"W	29 (13)
15205-X01	Cable Runway Mounting Bracket, for 6 to 24 (150 to 600) W Cable Runway	5 (2.3)
15330-X01	Center Rail, Square Punched, 38U, 72 (1800) H	20 (9.1)
15330-X03	Center Rail, Square Punched, 45U, 84 (2100) H	23 (10.4)
15330-X15	Center Rail, Square Punched, 51U, 96 (2400) H	26 (11.8)
15330-X08	Center Rail, Square Punched, 58U, 108 (2740) H	29 (13.2)
15335-X01	Center Rail, Threaded #12-24, 38U, 72 (1800) H	20 (9.1)
15335-X03	Center Rail, Threaded #12-24, 45U, 84 (2100) H	23 (10.4)
15335-X15	Center Rail, Threaded #12-24, 51U, 96 (2400) H	26 (11.8)
15335-X08	Center Rail, Threaded #12-24, 58U, 108 (2740) H	29 (13.2)

X=Color; 1=Gray, 7=Black, E=Glacier White

*Not available in Clear.

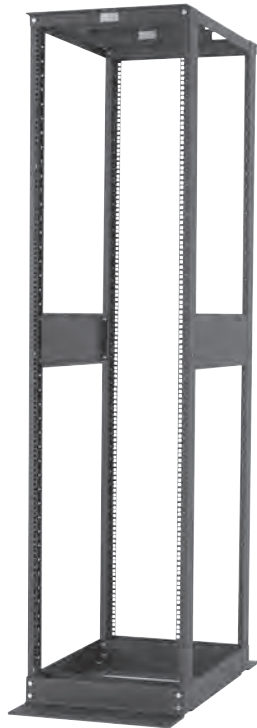

QuadraRack Server Frame

Designed specifically for rack-mount servers, the QuadraRack Server Frame offers the strength and stability of a cabinet, but in an open mounting system. Providing easy access for simplified installation and cabling, the QuadraRack Server Frame offers unrestricted airflow for improved cooling and heat dissipation. The unique, steel C-shaped channels with square holes and horizontal braces, were designed to provide optimal torsional strength. The horizontal braces are quick and easy to install with the supplied carriage bolts. Since rack-mount servers require various types of mounting screws, cage nuts provide the flexibility.

- 19"W EIA
- Manufactured from aluminum and steel
- Available in powder coat color finishes: Gray, Black or Glacier White
- EIA-310 Standard Universal 5/8" - 5/8" - 1/2" (15.9 mm - 15.9 mm - 12.7 mm) alternating hole pattern
- Square-punched mounting holes adapt with Clik-Nuts or cage nuts (listed below) to match equipment mounting requirements
- Top Extension Pan Set provides two 6" x 16" (150 mm x 410 mm) cable access ports
- Frame depth is 29" (740 mm) with overall depth of 41" (1040 mm) from edge-to-edge of base angles
- Load Rating: 1000 lb (453.6 kg) — weight must be evenly distributed, and rack must be properly secured to the floor

QuadraRack Server Frame Kit includes:

- (4) Rack Channels
- (2) Base Angles
- (2) Top Angles
- (1) Extension Pan Set
- (8) Plate Nuts and Assembly Hardware
- (2) Horizontal Braces

Part Number	Description H x W x D Height - ft (m), Depth - in (mm)	Shipping Weight lb (kg)
15053-X03	7 (2.1) x 19 x 29 (740), 45U	77 (34.9)

X=color; 1=Gray, 7=Black, E=Glacier White



Steel Channels with square holes adapt to server mounting screws



Clik-Nut Hardware Kit, featuring a squeeze-and-release design, is available for square-punched rail options.

Square-Punched Hardware Kits (sold separately)

Part Number	Nominal Size	Package Of	Finish	Shipping Weight lb (kg)
12637-001	M-6	25	Gold Over Zinc	1 (0.5)
12638-001	10-32	25	Zinc	1 (0.5)
12639-001	12-24	25	Black	1 (0.5)

Clik-Nut Hardware Kit

Part Number	Thread Size	Package Of	Shipping Weight lb (kg)
76543-X01	M6 x 1.0	25	1 (0.5)
76544-X01	12-24	25	1 (0.5)
76545-X01	10-32	25	1 (0.5)

X=color; 0=Zinc, 7=Black Zinc



Not intended for rack-mount servers

HCAI-OPM-0260



QuadraRack 4-Post Frame

The QuadraRack 4-Post Frame offers the strength and stability of a cabinet in an open mounting system. Enjoy easy equipment installation, along with unrestricted airflow for improved cooling and heat dissipation.

- 19" W EIA
- Manufactured from aluminum
- EIA-310 Standard Universal 5/8" - 5/8" - 1/2" (15.9 mm - 15.9 mm - 12.7 mm) alternating hole pattern, mounting holes are roll-formed #12-24
- Ships unassembled
- Load Rating: 2000 lb (907.2 kg) — weight must be evenly distributed, and rack must be properly secured to the floor

QuadraRack 4-Post Frame Kit includes:

- (4) Rack Channels
- (2) Base Angles
- (2) Top Angles
- (1) Extension Pan Set
- (1) Bag of 100 Rack mounting screws — Pilot Point #12-24 with combination Phillips/Straight head

Part Number	Description H x W x D Height - ft (m), Depth - in (mm)	Shipping Weight lb (kg)
50120-X03	7 (2.1) x 19 x 29 (740), 45U	65 (29.5)
50120-X15	8 (2.4) x 19 x 29 (740), 51U	67 (30.4)
50120-X08	9 (2.7) x 19 x 29 (740), 58U	69 (31.3)

X=color: 1=Gray, 5=Clear, 7=Black, E=Glacier White

ExpandARack

Convert a CPI two-post rack to a QuadraRack with ExpandARack.

Part Number	Description H x W x D Height - ft (m), Depth - in (mm)	Shipping Weight lb (kg)
ExpandARack - Standard Rack		
50110-X03	7 (2.1) x 19 x 29 (740), 45U	46 (20.9)
50110-X15	8 (2.4) x 19 x 29 (740), 51U	48 (21.8)
50110-X08	9 (2.7) x 19 x 29 (740), 58U	50 (22.7)
ExpandARack - Universal Rack		
50130-X03	7 (2.1) x 19 x 29 (740), 45U	52 (23.6)
50130-X15	8 (2.4) x 19 x 29 (740), 51U	55 (24.9)
50130-X08	9 (2.7) x 19 x 29 (740), 58U	58 (26.3)
ExpandARack - Pan Set (W x D)		
50150-X99	19 x 29 (740) — Standard Rack	18 (8.2)
50160-X99	19 x 29 (740) — Universal Rack	18 (8.2)

X=color: 1=Gray, 5=Clear, 7=Black, E=Glacier White

1U



16351-X19

1U



16350-X19

2U

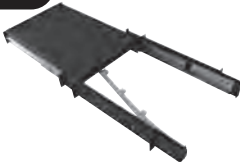

12700-X19

3U



16356-X19



16341-X19

QuadraRack Accessories

Heavy Duty Fixed Shelf - Solid

Specially designed for QuadraRack. 1U x 19"W x 29"D (740 mm) shelf. Supports up to 200 lb (90.7 kg).

Heavy Duty Fixed Shelf - Vented

Specially designed for QuadraRack. 1U x 19"W x 29"D (740 mm) vented shelf that optimizes airflow. Supports up to 200 lb (90.7 kg).

Extra Heavy Duty 4-Point Sliding Shelf

Specially designed to support heavy equipment. 2U x 19"W x 26"D (660 mm) sliding shelf, extends 24" (610 mm), adjusts between 20" and 34" (510 mm and 860 mm) mounting depth. Supports up to 300 lb (136.1 kg).

Equipment Tie-Down Bracket

Prevents back-and-forth, side-to-side and up-and-down movement of shelf-mount equipment. 3U x 19"W x 23"D (580 mm).

Dust Cover

Improves the appearance of QuadraRack 4-Post Frame and prevents the accumulation of dust and debris at the base.

Power Strips

Both horizontal and vertical power strips can be mounted to the QuadraRack. These solutions can be found in Section 7.

Part Number	Description H x W Height - ft (m)	Shipping Weight lb (kg)
16351-X19	Heavy Duty Fixed Shelf, Solid	11 (5.0)
16350-X19	Heavy Duty Fixed Shelf, Vented	11 (5.0)
12700-X19*	Extra Heavy Duty Sliding Shelf*	29 (13)
16342-X01	Rack Line-Up Spacer, Universal	1 (0.5)
16342-X02	Rack Line-Up Spacer, Standard	1 (0.5)
16356-X19	Equipment Tie-Down Bracket	4 (1.8)
16341-X19	Rack Base Dust Cover	4 (1.8)

X=Color: 1=Gray, 5=Clear, 7=Black, E=Glacier White

*Not available in Clear.

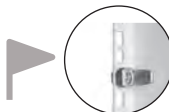

Klik-Nut® cage nuts make installation time quick and easy. Go to page 2-20 for ordering information.

PATENTED

2U

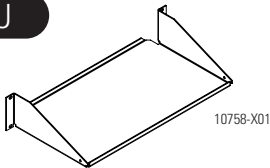

10758-X01

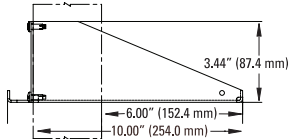

Shelves

Small Peripheral Shelf

Designed to hold small peripheral equipment in a central location. Each shelf typically holds two units and allows a convenient cable run down the inside of the rack channel. Mounting hardware not included. 19" rack mountable, holds equipment up to 17.35"W x 9.82"D (440.7 mm x 249.4 mm). Made of strong, lightweight aluminum; supports up to 50 lb (22.7 kg).

Single-Sided Shelf

A convenient 15"D (380 mm) mounting shelf for miscellaneous equipment, test gear, etc. Mounting hardware not included. 19" version holds equipment up to 17.25"W x 14.82"D (438.2 mm x 376.4 mm), 23" version holds equipment up to 21.25"W x 14.82"D (539.8 mm x 376.4 mm). Made of strong, lightweight aluminum; supports up to 50 lb (22.7 kg). 19" version is UL Listed: File E140851; Category DUXR (US), DUXR7 (Canada) – Communications Circuit Accessory.

3U

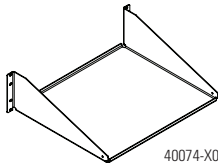

40074-X00

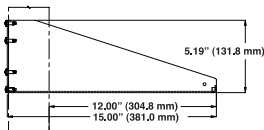

Single-Sided Vented Shelf

Supports routers, switches, CPUs or any equipment requiring bottom ventilation. Mounting hardware not included. 19" version holds equipment up to 17.25"W x 14.82"D (438.2 mm x 376.4 mm), 23" version holds equipment up to 21.25"W x 14.82"D (539.8 mm x 376.4 mm). Wall, backboard or rack mountable. Made of strong, lightweight aluminum with airflow perforations; supports up to 50 lb (22.7 kg).

16"D (410 mm) Low-Profile Shelf

Reduced height design saves on valuable rack space. Center mount design is ideal for single sided racks, mounts to either front or back of rack channel face. Mounting hardware not included. 19"W version holds equipment up to 17.25"W x 15.82"D (438.2 mm x 401.8 mm), 23"W version holds equipment up to 21.25"W x 15.82"D (539.8 mm x 401.8 mm). Made of strong, lightweight aluminum; supports up to 40 lb (18.1 kg).

3U

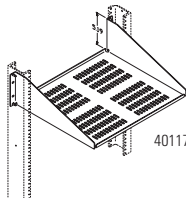

40117-X19

2U

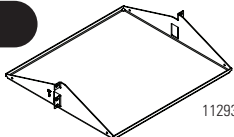

11293-X19

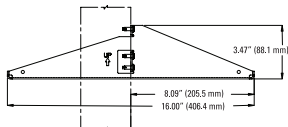

Part Number	Description	Shipping Weight lb (kg)
10758-X01	Small Peripheral Shelf, 19"W	5 (2.3)
40074-X00	Single-Sided Shelf, For 19" Rack	6 (2.7)
40075-X00	Single-Sided Shelf, For 23" Rack	7 (3.2)
40117-X19	Single-Sided Vented Shelf, For 19" Rack	6 (2.7)
40118-X23	Single-Sided Vented Shelf, For 23" Rack	7 (3.2)
11293-X19	Low-Profile Shelf, For 19" Rack	4 (1.8)
11293-X23	Low-Profile Shelf, For 23" Rack	5 (2.3)

X=color: 1=Gray, 5=Clear, 7=Black, E=Glacier White

3U

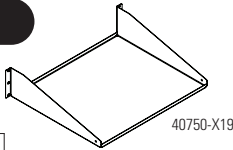

40750-X19

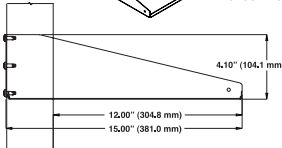

Shelves

Standard Single-Sided Steel Shelf

Economical rack or wall-mounted shelf for miscellaneous equipment. Made of cold-rolled steel and may be rack or wall-mounted. 19" rack-mountable, holds equipment up to 17.25"W x 14.75"D (438.2 mm x 374.7 mm). Supports up to 35 lb (15.9 kg).

Standard Double-Sided Steel Shelf

An economical rack or wall-mounted shelf with twice the shelf space for centered loading and deeper equipment handling. Made of cold-rolled steel, this shelf mounts on double-sided racks only. 19"W rack-mountable, holds equipment up to 17.25"W x 21.50"D (438.2 mm x 546.1 mm) and supports up to 25 lb (11.3 kg) per side or 50 lb (22.7 kg) total.

3U

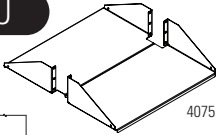

40751-X19

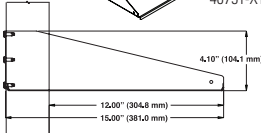

2U

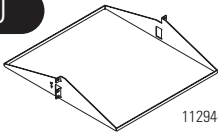

11294-X19

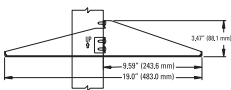

5U

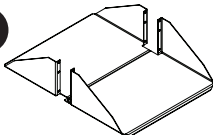

11054-X19

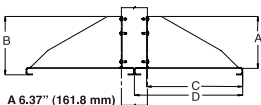

- A 6.37" (161.8 mm)
- B 7.16" (181.9 mm)
- C 11.53" (292.9 mm)
- D 13.00" (330.2 mm)

19" D (480 mm) Low-Profile Shelf

Reduced height design saves on valuable rack space. Mounts to either front or back of rack channel face. Mounting hardware not included. 19" version holds equipment up to 17.25"W x 18.82"D (438.2 mm x 478.0 mm), 23" version holds equipment up to 21.25"W x 18.82"D (539.8 mm x 478.0 mm). Made of strong, lightweight aluminum; supports up to 40 lb (18.1 kg).

26" D (660 mm) Shelf

Extra deep design is convenient for mounting large equipment requiring additional support. Will fit inside most CPI rack enclosures, except P/N 11058 or wall enclosure). Mounting hardware not included. 19" version holds equipment up to 17.75"W x 25.8"D (450.9 mm x 655.8 mm), 23" version holds equipment up to 21.75"W x 25.8"D (552.5 mm x 655.8 mm). Made of strong, lightweight aluminum; supports up to 150 lb (68.0 kg). 19" version is UL Listed: File E140851; Category DUXR (US), DUXR7 (Canada) – Communications Circuit Accessory.

Part Number	Description	Shipping Weight lb (kg)
40750-X19*	Standard Single-Sided Steel Shelf	12 (5.4)
40751-X19*	Standard Double-Sided Steel Shelf	10 (4.5)
11294-X19	Low Profile Shelf, For 19" Rack	5 (2.3)
11294-X23	Low Profile Shelf, For 23" Rack	6 (2.7)
11054-X19	26" D (660 mm) Shelf, For 19" Rack	10 (4.5)
11054-X23	26" D (660 mm) Shelf, For 23" Rack	10 (4.5)

X=color: 1=Gray, 5=Clear, 7=Black, E=Glacier White

*Shelves are not available in clear finish.



4U

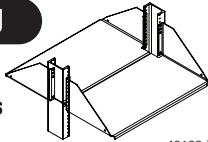

40108-X19

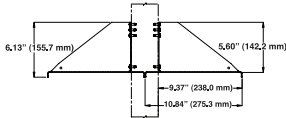

4U

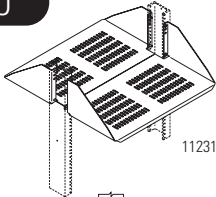

11231-X19

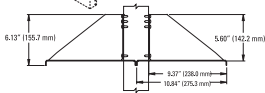

2U

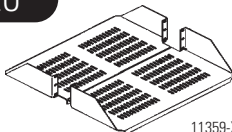

11359-X19

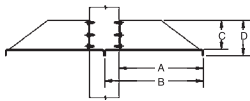

- A 8.53" (216,7 mm)
- B 10,0" (254,0 mm)
- C 2.91" (73.9 mm)
- D 3.53" (89,7 mm)

Shelves

Double-Sided Shelf

Provides centered loading for deeper and heavier equipment. Mounts on 3"D (80 mm) double-sided racks only. Mounting hardware not included. 19" version holds equipment up to 17.75"W x 21.5"D (450.9 mm x 546.0 mm), 23" version holds equipment up to 21.75"W x 21.5"D (552.5 mm x 546.0 mm). Made of strong, lightweight aluminum; supports up to 100 lb (45.4 kg). 19" version is UL Listed: File E140851; Category DUXR (US), DUXR7 (Canada) – Communications Circuit Accessory.

Double-Sided Vented Shelf

Convenient for mounting any equipment requiring bottom ventilation, airflow perforations for increased airflow around components. Mounting hardware not included. 19" version holds equipment up to 17.75"W x 21.5"D (450.9 mm x 546.0 mm). Made of strong, lightweight aluminum; supports up to 100 lb (45.4 kg).

Double-Sided Low-Profile Vented Shelf

Reduced height design saves valuable rack space and perforated shelf keeps equipment cool, includes bottom ventilation for enhanced airflow circulation. Mounting hardware not included. 19" version holds equipment up to 17.75"W x 19.8"D (450.9 mm x 503.4 mm). Mounts on 3"D (80 mm) double-sided racks only. Made of strong, lightweight aluminum; supports up to 60 lb (27.2 kg)

Part Number	Description	Shipping Weight lb (kg)
40108-X19	Double-Side Shelf, For 19" Rack	8 (3.6)
40108-X23	Double-Side Shelf, For 23" Rack	9 (4.1)
11231-X19	Double-Side Vented Shelf, For 19" Rack	8 (3.6)
11359-X19	Low-Profile Vented Shelf For 19" Rack	8 (3.6)
11359-X23	Low-Profile Vented Shelf For 23" Rack	9 (4.1)

X=color: 1=Gray, 5=Clear, 7=Black, E=Glacier White

5U

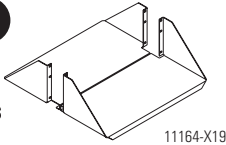

11164-X19

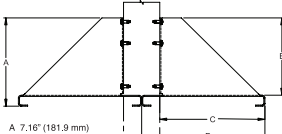

A 7.16" (181.9 mm)

5U

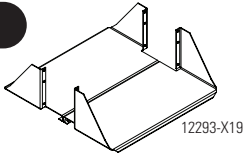

12293-X19

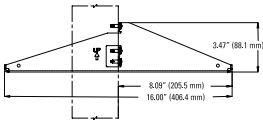

3.47" (88.1 mm)
8.09" (206.3 mm)
16.09" (408.4 mm)

4U

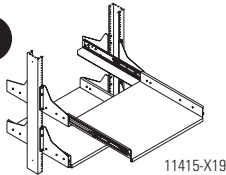

11415-X19

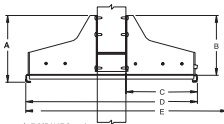

A 7.20" (117.8 mm)
B 6.37" (162.8 mm)
C 7.48" (190.0 mm)
D 16.07" (407.9 mm)
E 34.62" (879.3 mm)

Shelves

Heavy Duty Equipment Shelf for 3" (80 mm) Channel

Convenient for mounting large equipment requiring additional support. Mounting hardware not included. 19" version holds equipment up to 17.75"W x 19.8"D (450.9 mm x 503.4 mm), 23" version holds equipment up to 21.75"W x 19.8"D (552.5 mm x 503.4 mm). Made of strong, lightweight aluminum; supports up to 200 lb (90.7 kg). 19" version is UL Listed: File E140851; Category DUXR (US), DUXR7 (Canada) – Communications Circuit Accessory.

Heavy Duty Equipment Shelf for 6" (150 mm) Channel

This shelf is designed to hold heavy equipment requiring extra support. Fits Standard Rack 6"D (150 mm) and SeismicFrame® Two Post Rack. Mounting hardware not included. 19" version holds equipment up to 17.75"W x 19.8"D (450.9 mm x 503.4 mm). Made of strong, lightweight aluminum; supports up to 200 lb (90.7 kg).

Sliding Equipment Shelf

Provides a sliding shelf for front access to all equipment. Mounting hardware not included. 18"D (460 mm) shelf extends out an additional 16" (410 mm) from closed position. Lockable in fully extended and fully retracted positions. 19" version holds up to 16"W x 17.5"D (410 mm x 445 mm) equipment, 23" version holds up to 20"W x 17.5"D (510 mm x 445 mm) equipment. Mounts on 3"D (80 mm) double-sided racks only. Made of sturdy, lightweight aluminum; supports up to 100 lb (45.4 kg).

Part Number	Description	Shipping Weight lb (kg)
11164-X19	Heavy Duty Shelf for 3" (80 mm) Channel, For 19" Rack	8 (3.6)
11164-X23	Heavy Duty Shelf for 3" (80 mm) Channel, For 23" Rack	9 (4.1)
12293-X19	Heavy Duty Shelf for 6" (150 mm) Channel, For 19" Rack	10 (4.5)
11415-X19	Sliding Equipment Shelf, For 19" Rack	13 (5.9)
11415-X23	Sliding Equipment Shelf, For 23 Rack	13 (5.9)

X=Color: 1=Gray, 5=Clear, 7=Black, E=Glacier White

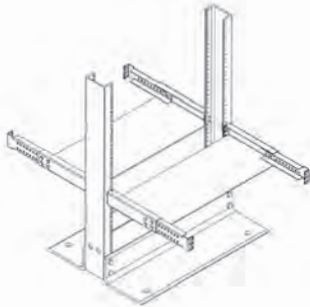

A split-pan design provides a broader surface area to support server weight

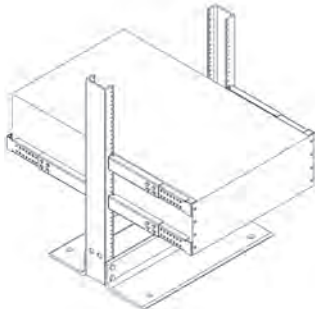

anyServer Bracket shown on rack with server and optional Server Support Arms

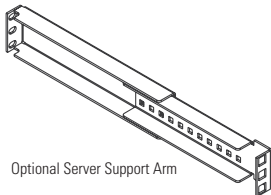

Optional Server Support Arm

anyServer Bracket

The anyServer Bracket is a simple, yet sturdy solution to secure virtually any server to a 19"W, two-post open rack. It is the ideal, cost-effective system for retrofitting existing racks to accommodate one or more servers, instead of reverting to a four-post rack or cabinet system. The anyServer Bracket can be adjusted to fit all of your server's requirements, enabling you to keep the same mounting system, even if you change equipment in the future.

Purchase optional Supplementary Server Support Arms to firmly secure the tops of tall servers to the rack. In some instances, they can also help you mount your server if its captive screw holes are in the middle or top of the device.

The anyServer Bracket comes with front and rear steel pans and four steel adjustable arms (with mounting hardware).

- Manufactured from cold rolled steel
- The server can be positioned 9" to 13" (230 mm to 330 mm) in front of the rack channel; mounting arms extend 4" (100 mm) total in .5" (10 mm) increments
- Square holes at the front of adjustable mounting arms for Clic-Nuts or cage nuts (sold separately)
- Acorn nuts eliminate sharp edges
- Supplementary arms (purchased separately) provide extra support
- Load rating:
 - 1U bracket is 80 lb (36.3 kg)
 - 2U bracket is 120 lb (54.4 kg)
- Rack mounting hardware is not included

Part Number	Description	Shipping Weight lb (kg)
12751-719	1U x 19, Black Bracket	11 (5.0)
12752-719	2U x 19, Black Bracket	14 (6.4)
12759-701	Supplementary Server Support Arms, Fixed, 1 Pair, 1U, Black	3 (1.4)

Square-Punched Hardware Kits (sold separately)

Part Number	Nominal Size	Package Of	Finish	Shipping Weight lb (kg)
12637-001	M-6	25	Gold Over Zinc	1 (0.5)
12638-001	10-32	25	Zinc	1 (0.5)
12639-001	12-24	25	Black	1 (0.5)

Lockable Storage Drawer

CPI's improved Lockable Storage Drawer keeps backup media, software, manuals, laptops, test equipment and extra patch cords in close proximity to where they are typically used within a rack or cabinet.

Lockable Storage Drawer is available for 19"W or 23"W racks and cabinets. It includes attachment brackets that allow center mounting on two-post racks with 3" or 6"D (80 mm or 150 mm) equipment channels, or front and rear attachment to four-post racks and cabinet systems with mounting rails that are adjusted between 24" and 39"D (610 mm and 990 mm).

- Attaches to any CPI free-standing 19"W or 23"W rack or cabinet system
- Available in three heights: 2U, 3U and 4U
- Features 20"D (510 mm) lockable drawer that extends full-depth for easy access to stored equipment
- Redesigned to allow for stackable units
- Supports a 100 lb (45.4 kg) load (drawer and top surface combined)



Drawer with two-post mounting brackets



Drawer with four-post mounting brackets

Part Number	Description	Shipping Weight lb (kg)
19" Rack or Cabinet Mount - Depth - in (mm)		
13082-X19	2U Drawer, 20 (510)	18 (8.2)
13083-X19	3U Drawer, 20 (510)	20 (9.1)
13084-X19	4U Drawer, 20 (510)	22 (10.0)
23" Rack or Cabinet Mount - Depth - in (mm)		
13082-X23	2U Drawer, 20 (510)	21 (9.5)
13083-X23	3U Drawer, 20 (510)	23 (10.4)
13084-X23	4U Drawer, 20 (510)	25 (11.3)

X=color: 1=Gray, 5=Clear, 7=Black, E=Glacier White

2U

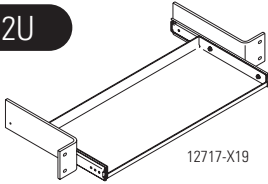

12717-X19

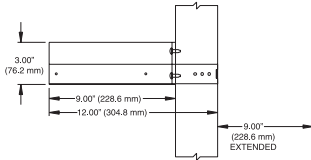

Flush Mounted Keyboard Tray

Provides retractable rack-mounting tray for most keyboards up to 8.5"D (216 mm). Mounting hardware not included. Extends 8" (200 mm), giving full access to keyboard. Retracts when not in use. 19" version holds up to 16.1"W (409 mm) keyboards. Made of strong, lightweight aluminum. This tray does not support the mouse pad attachment.

CPU/Monitor Shelf with Single Sliding Keyboard Tray

Provides convenient mounting of CPU or monitor and keyboard. Mounting hardware not included. Keyboard tray extends 8.6" (218 mm), 19"W rack trays must use small footprint keyboard; maximum width 16.30" (414 mm). 19" holds equipment up to 17.75"W x 19.82"D (450.9 mm x 503.4 mm), 23" holds equipment up to 21.75"W x 19.82"D (552.5 mm x 503.4 mm). Made of strong, lightweight aluminum; supports up to 200 lb (90.7 kg).

6U

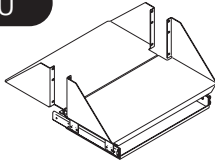

11487-X19

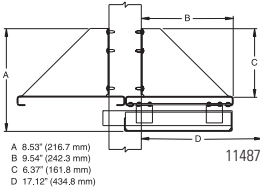

Part Number	Description	Shipping Weight lb (kg)
12717-X19*	Flush Mount Keyboard Tray, For 19" Racks	8 (3.6)
11487-X19	Monitor Shelf, Single Tray, For 19" Rack	12 (5.4)
11487-X23	Monitor Shelf, Single Tray, For 23" Rack	12 (5.4)

X=color: 1=Gray, 5=Clear, 7=Black, E=Glacier White

*19" rack tray must use small footprint keyboard.

2U

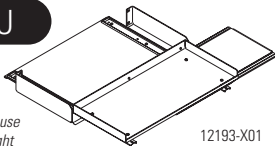

12193-X01

Note: Mouse pad on right side only

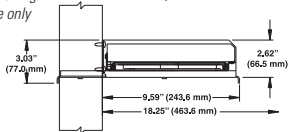

2U

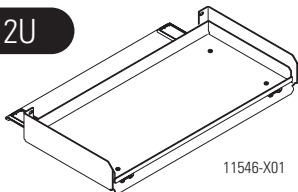

11546-X01

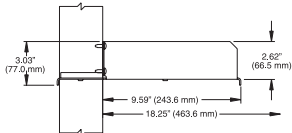

19" Full Size Sliding Keyboard & Mouse Tray

Holds full size keyboard and mouse. Slide is mounted under shelf to provide maximum tray width. Mounting hardware not included. Mouse pad tray is 10"W x 8"D (250 mm x 200 mm) and retracts out of the way when not in use. Fits up to 19.25"W x 9"D (489 mm x 230 mm) keyboards. Extends approximately 9" (230 mm) for full access to keyboard. Made of strong, lightweight aluminum.

19" Full Size Sliding Keyboard Tray

Tray holds full size keyboard with slide mounted under shelf to provide maximum tray width. Mounting hardware not included. Extends approximately 9" (230 mm) for full access to keyboard. Fits up to 19.25"W x 9"D (489 mm x 230 mm) keyboards. Made of strong, lightweight aluminum.

Note: Does not support the mouse pad attachment.

Part Number	Description	Shipping Weight lb (kg)
12193-X01*	19" Sliding Keyboard Tray	9 (4.1)
11546-X01	19" Full Size Keyboard Tray	9 (4.1)

X=Color: 1=Gray, 5=Clear, 7=Black, E=Glacier White

*Also available, Mouse Pad Attachment (P/N 11692-XXX) and 23" Wrist Rest Attachment (P/N 12306-XXX).

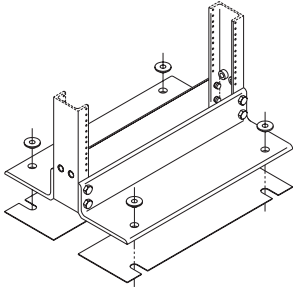

Rack Base Insulator Kit

Rack Base Insulator Kits electrically isolate the racks from the floor for an effective grounding and bonding system.

Kit consists of:

- (2) isolation plates; (4) isolation grommets

Part Number	Description	Shipping Weight lb (kg)
10605-019	Insulator Kit, 19" Rack	3 (1.4)
10605-023	Insulator Kit, 23" Rack	3 (1.4)

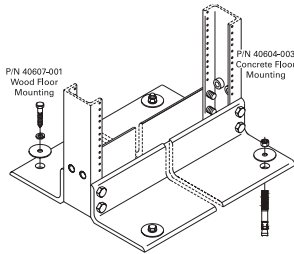

Rack and Frame Installation Kits

Required hardware for securing equipment racks and frames to both concrete and wood floors. Concrete Kit has four 3/8" thread components or four 1/2" thread components. Wood kit has four 3/8" thread components.

Part Number	Floor Type	Finish	Shipping Weight lb (kg)
40604-001	Concrete Floor, 3/8"	Zinc	1 (0.5)
40604-003	Concrete Floor, 1/2"	Zinc	1 (0.5)
40607-001	Wood Floor, 3/8"	Zinc	1 (0.5)

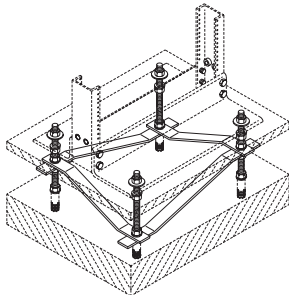

Rack with 3"(80 mm) channel shown

Raised Floor Rack Support Kit

Support racks installed on 4" to 36" (100 mm to 910 mm) height raised floor support systems. Mounted base floor using 5/8" threaded rods and steel brackets.

Kits consists of:

- (4) pre-cut threaded rods; (4) "Z" brackets; All mounting hardware

19" Rack	23" Rack	Height of Floor in (mm)	Shipping Weight lb (kg)
3" (80 mm) Rack Channel			
10632-119	10632-123	4 to 10 (100 to 250)	15 (6.8)
10629-119	10629-123	10 to 16 (250 to 410)	18 (8.2)
10630-119	10630-123	16 to 22 (410 to 560)	20 (9.1)
10631-119	10631-123	22 to 28 (560 to 710)	23 (10.4)
13501-119	13501-123	30 to 36 (760 to 910)	34 (15.4)
6" (150 mm) Rack Channel			
11760-119	11760-123	4 to 10 (100 to 250)	15 (6.8)
11761-119	11761-123	10 to 16 (250 to 410)	18 (8.2)
11762-119	11762-123	16 to 22 (410 to 560)	21 (9.5)
11763-119	11763-123	22 to 28 (560 to 710)	24 (10.9)
13515-119	13515-123	30 to 36 (760 to 910)	34 (15.4)



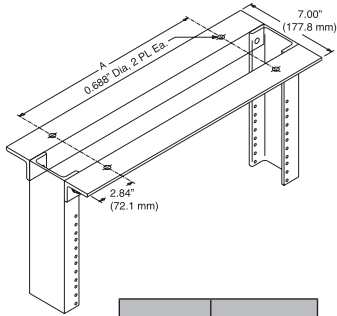

Rack Width	A in (mm)
19"	14.57 (370.1)
23"	18.57 (471.1)

Heavy-Duty Top Angle

Optional top angle for CPI Universal, Standard or 6"D (150 mm) Standard Racks.

- Material is aluminum extrusion, 1 1/2" x 2" x 1/4" (38.1 mm x 51 mm x 6.4 mm) with two 11/16" (17.46 mm) punched holes in top surface
- Recommended to be used in pairs with 10562-001 bracing
- Sold individually

Part Number			
19" Rack	Dim. A	23" Rack	Dim. A
10473-X01	14.57 (370.1)	10473-X02	18.57 (471.7)

X=Color; 1=Gray, 5=Clear, 7=Black, E=Glacier White

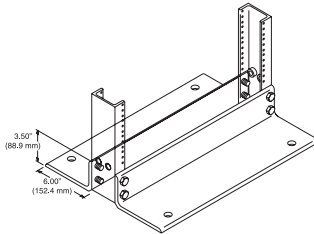

Base Angle

Optional base angle for CPI Universal Racks.

- Material is aluminum extrusion 3-1/2" x 6" x 3/8" (89 mm x 150 mm x 9.53 mm)
- Sold individually

Part Number	Description	Shipping Weight lb (kg)
41021-X01	For 19" Rack	10 (4.5)
41021-X02	For 23" Rack	10 (4.5)

X=Color; 1=Gray, 5=Clear, 7=Black, E=Glacier White

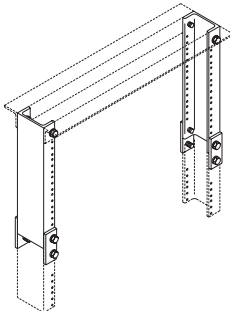

Rack Extension Kit

Provides additional height to existing racks. Kit includes one pair of rack channels, four plates and assembly hardware.

- Universal 5/8" - 5/8" - 1/2" (15.9 mm - 15.9 mm - 12.7 mm) hole pattern

Part Number	Description	Shipping Weight lb (kg)
10565-X12	12"H (300 mm), 4U	4 (1.8)
10565-X24	24"H (610 mm), 11U	6 (2.7)

X=Color; 1=Gray, 5=Clear, 7=Black, E=Glacier White

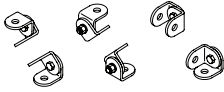
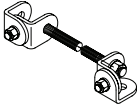

Installation Drawings:

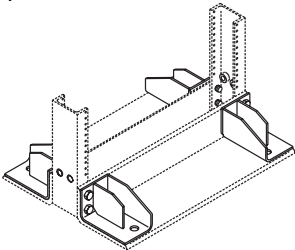
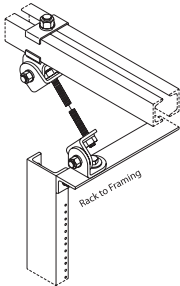
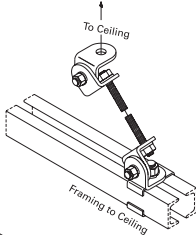
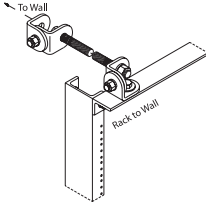

Universal Earthquake Bracing Kit

This adjustable wall/ceiling brace provides a means of securing an equipment rack or auxiliary frame to meet earthquake safety codes.

- Material is 2" x 1/4" (50 mm x 6.35 mm) steel finished with Gold Chem Film over zinc plating

Kit consists of:

- (4) brackets (make 2 swivel brackets)
- (2) 1/2-13 x 1 1/4" hex bolts
- (2) 1/2-13 hex nuts
- (2) 1/2" split lock washers

Part Number	Description	Shipping Weight lb (kg)
10562-001	Universal Earthquake Bracing Kit	3 (1.4)

Note: Seismic installation requirements should be approved by a licensed structural engineer.

Installation will require (not included):

- (1) 5/8-11 threaded rod of appropriate length
Rod must be trimmed to proper length during installation
- (2) 5/8-11 hex nuts
- (2) 5/8 flat Type A washer, wide
- Clip kit and hardware for attachment to channel or bar

Installation may also require (not included):

For concrete ceiling:

- (1) 5/8-11 concrete anchor
- (1) 5/8-11 x 3" stud
- (2) 5/8-11 hex nuts
- (1) 5/8" split lock washer
- (1) 5/8" flat, washer, wide, Type A

For auxiliary frame or grid:

- (1) Grid Clamp Kit
- (1) 5/8-11 x 3 1/4" hex screw cap
- (1) 5/8-11 hex nut
- (1) 5/8" split lock washer

For rack:

- (1) 5/8-11 x 1 1/4" hex cap screw
- (1) 5/8-11 hex nut
- (1) 5/8" split lock washer

For plywood backboard:

- (1) 5/8" x 2" hex lag screw
- (1) 5/8" split lock washer

Rack Seismic Gusset Kit

The Rack Seismic Gusset and Hardware Kit can be added to any CPI Universal Rack (46XX series) to stiffen critical load bearing joints, reducing the need to stabilize the top of the rack.

- Adds additional support to critical rack joints
- Kit can be added to any CPI Universal Rack (46XXX series)

Kit consists of:

- (4) welded steel bolt-on gussets
- (8) 1/2-13 x 1-1/4" bolts
- (8) 1/2-13 nuts

Part Number	Description	Shipping Weight lb (kg)
11592-X01	Gusset and Hardware Kit	10 (4.5)

X=Color; 1=Gray, 7=Black Note: Seismic installation requirements should be approved by a licensed structural engineer.

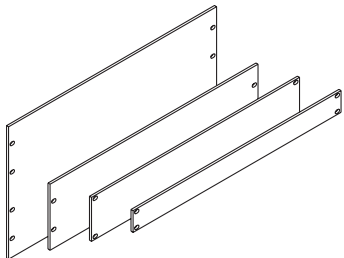

Filler Panels

For airflow control and/or equipment mounting, fill empty spaces between mounted equipment.

Filler Panels				
300	Filler Panels			
	Thickness - in (mm)	Width		
24	3/16 (4.763)	19"		
25	3/16 (4.763)	23"		
26	1/8 (3.18)	19"		
27	1/8 (3.18)	23"		
Color				
1	Gray			
5	Clear			
7	Black			
E	Glacier White			
Spaces - in (mm)				
	Spaces - in (mm)	U		
01	1.72 (43.7)	1		
02	3.47 (88.1)	2		
03	5.22 (132.6)	3		
04	6.97 (177.0)	4		
05	8.72 (221.5)	5		
06	10.47 (265.9)	6		
07	12.22 (310.4)	7		
08	13.97 (354.8)	8		
09	15.72 (399.3)	9		
10	17.47 (443.7)	10		
11	19.22 (488.2)	11		
12	20.97 (532.6)	12		
300	XX	-	X	XX



12 oz (340 g)
pressurized can



25401-X00

Touch-Up Paint

Air dry lacquer for touching up finish. Matches color and gloss of CPI's textured paint. Air dries to hard finish in minutes.

- 12-ounce (340 g) pressurized can Note: Cannot be shipped via air.

Air dry waterborne paint for touching up finish. Matches color and gloss of CPI's textured paint.

- 1-ounce (30 g) bottle with applicator

Part Number	Description oz (g)	Shipping Weight lb (kg)
25400-X00	12 (340) Can	2 (0.9)
25401-X00	1 (30) Bottle	1 (0.5)

X=Color, 1=Gray, 7=Black, E=Glacier White.

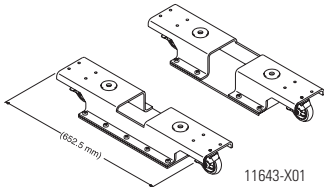

11643-X01

Note: Vertical cabling sections cannot be used on dolly-equipped racks. Also, dolly will not fit 6"D (150 mm) Standard Rack.

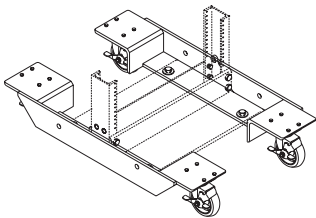

10175-X00

Note: Vertical cabling sections cannot be used on dolly-mounted racks. Can be used with Universal, 3"D (80 mm) Standard or 6"D (150 mm) Standard Racks.

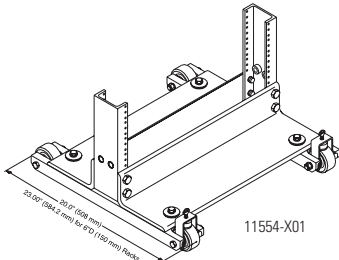

11554-X01

Mid-Size Rack Dolly

Full swivel capability allows rack to be easily moved, providing access to equipment. The front wheel locks to prevent unintentional movement. Mounts to most CPI Universal and Standard Racks and adds 1-1/4" (31.8 mm) to rack's height. Two-piece construction of 1/4" (6.4 mm) aluminum complete with hardware. Sold in pairs; load capacity 750 lb (340.2 kg).

Rack Universal Dolly Wheels

Allows rack to be moved, providing access to equipment. Wheels may be locked to prevent moving during assembly stages. Holds any width CPI Universal or Standard Rack. Two-piece construction of 3/8" (9.53 mm) aluminum complete with rack-mounting hardware. Supports up to 1000 lb (453.6 kg).

Note: Not to be used with enclosures.

Rack Standard Rollers

Mount to CPI Universal and Standard Racks, regardless of width. Fixed rollers prevent rack from accidental turning. Adds 2" (50 mm) to rack's height. Ships complete with installation hardware. Supports up to 500 lb (226.8 kg).

Part Number	Description	Shipping Weight lb (kg)
11643-X01	Mid-Size Rack Dolly	24 (10.9)
10175-X00	Universal Dolly Wheels	20 (9.1)
11554-X01	Rack Standard Rollers, For 3"D (80 mm) Rack Channel	8 (3.6)
11554-X03	Rack Standard Rollers, For 6"D (150 mm) Rack Channel	8 (3.6)

X=Color: 1=Gray, 5=Clear, 7=Black

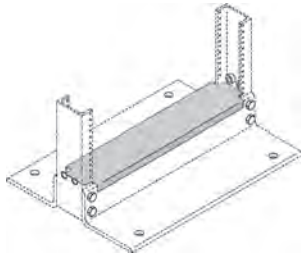

Rack Base Dust Cover

Improves appearance and prevents the accumulation of dust and debris at the rack base. Snaps securely in place over the base assembly; no mounting hardware necessary. Made of lightweight aluminum.

- For CPI Racks with 3"D or 6"D (80 mm or 150 mm) channel

Part Number			Description in (mm)
19" Rack	23" Rack	35" Rack	
41050-X19	41050-X23	N/A	3 (80) Rack Channel
42050-X19	42050-X23	42050-X35	6 (150) Rack Channel

X=color: 1=Gray,, 5=Clear, 7=Black, E=Glacier White

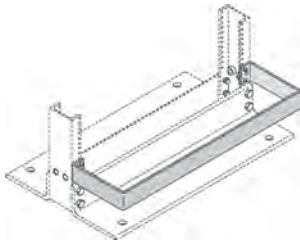

Equipment Guard Rail

Provides protection for equipment in racks from rolling gear or tool boxes.

- Made of 1/4" x 2" (6.4 mm x 50 mm) aluminum bar
- Mounting hardware is included; sold individually

400	Equipment Guard Rails			
	Stand Off - in (mm)			
	56	7 (180)		
	57	6.5 (165)		
	58	5.25 (133.4)		
	59	4.25 (108)		
	Color			
	1	Gray		
	5	Clear		
	7	Black		
	E	Glacier White		
	Width			
	19	19" Rack		
	23	23" Rack		
400	XX	-	X	XX

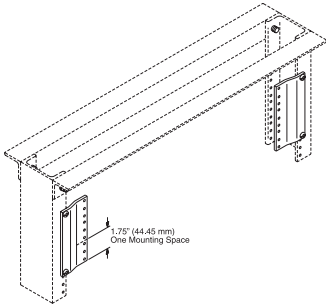

Rack Panel Adapters (Pair)

Allows 19"W equipment to be mounted on a 23"W rack.

- Universal 5/8" - 5/8" - 1/2" (15.9 mm - 15.9 mm - 12.7 mm)
- Joggled so that installed panels fit flush

Part Number	Description	Shipping Weight lb (kg)
31410-X00	Adapter, Pair, 1U, 1.71 (43.4)	1 (0.5)
31420-X00	Adapter, Pair, 2U, 3.46 (87.9)	1 (0.5)
31430-X00	Adapter, Pair, 3U, 5.21 (132.3)	1 (0.5)
31440-X00	Adapter, Pair, 4U, 6.96 (176.8)	1 (0.5)
31450-X00	Adapter, Pair, 5U, 8.71 (221.2)	1 (0.5)

X=color: 1=Gray, 5=Clear, 7=Black, E=Glacier White

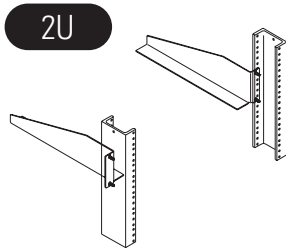

Sold in pairs. Attachment hardware not included.

Equipment Support Bracket

Equipment Support Bracket mounts to the rear rails to provide additional support and safety for deep or heavy electronic equipment panels and equipment mounted on CPI racks or cabinets.

- Supports equipment weighing up to 60 lbs (27.2 kg)
- Made of strong, lightweight aluminum
- Overall depth is 13" (330 mm); chassis support lip is 1.5"W (38 mm)
- Fits all EIA Standard, hole-patterned equipment mounting rails, cabinets and four-post racks
- Eliminates equipment deflection caused by cantilevered mounting

Part Number	Description	Shipping Weight lb (kg)
12312-X01	Pair of Brackets	2 (0.9)

X=color: 1=Gray, 5=Clear, 7=Black, E=Glacier White



RMU Label Kits

Easy-to-read numbers take the guesswork out of aligning components.

- Two kits are available: 1-45U for 7' (2.1 m) racks and cabinets and 1-58U for 8' or 9' (2.4 m or 2.7 m) racks and cabinets
- Kit contains four individual label packs, enough for four racks or four cabinets
- Labels are constructed of 1/2"W (10 mm) durable polyester film with adhesive backing and are Black with U numbers printed in White

Part Number	Description	Shipping Weight lb (kg)
11927-001	1-45U Label	1 (0.5)
11927-002	1-58U Label	1 (0.5)

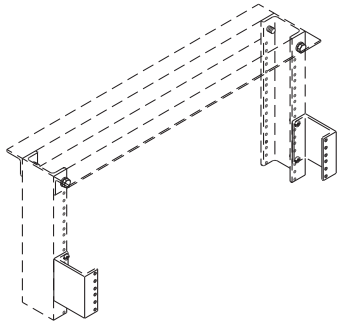

Rack Channel Standoffs

Rack Channel Standoffs offer solutions to many electronic component positioning problems, including:

- Adding deeper electronic components to existing CPI Wall Racks, Heavy Duty Wall Racks, Universal Swing Gate Wall Racks, Standard Swing Gate Wall Rack or Self-Support Racks
- Providing improved patch panel cable transitions when a double-sided cabling section is used with a 3" (80 mm) Rack Channel; use 1-1/2" (38 mm) Rack Channel Standoff
- Reposition rack-mounted electronic components to redistribute component weight or to realign component for whatever reason
- Available in three depths and six heights
- Packaged one pair per box

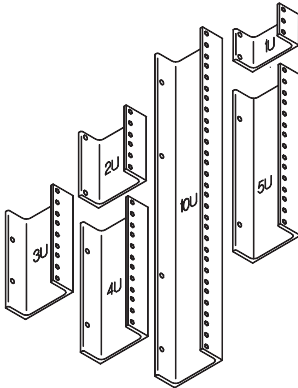

Front of channel tapped with #12-24 threaded holes, EIA 310 Universal holes spacing

Part Number	Overall Height	Mounting Holes	Shipping Weight lb (kg)
3" (80 mm) Rack Channel / 3" Depth (80 mm)			
12309-X01	1U	3	1 (0.5)
12309-X02	2U	6	1 (0.5)
12309-X03	3U	9	2 (0.9)
12309-X04	4U	12	2 (0.9)
12309-X05	5U	15	2 (0.9)
12309-X10	10U	30	4 (1.8)
3" (80 mm) Rack Channel / 6" Depth (150 mm)			
12310-X01	1U	3	1 (0.5)
12310-X02	2U	6	1 (0.5)
12310-X03	3U	9	2 (0.9)
12310-X04	4U	12	2 (0.9)
12310-X05	5U	15	2 (0.9)
12310-X10	10U	30	4 (1.8)
3" (80 mm) Rack Channel / 1-1/2" Depth (38 mm)			
12311-X01	1U	3	1 (0.5)
12311-X02	2U	6	1 (0.5)
12311-X03	3U	9	2 (0.9)
12311-X04	4U	12	2 (0.9)
12311-X05	5U	15	2 (0.9)
12311-X10	10U	30	4 (1.8)

X=Color: 1=Gray, 5=Clear, 7=Black, E=Glacier White

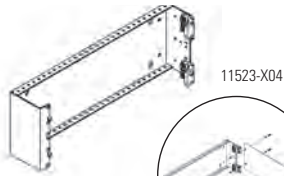

11523-X04

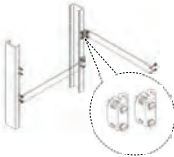
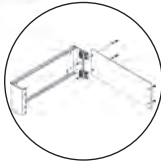

11520-00
Frame and Panel
not included.



Hinged Panel Mounting Bracket

Provides easy access to back of wall or rack-mounted panels.

- Can be mounted to open left or right
- Available in 2, 3, 4, 5 or 6 mounting space, 1.75" H (44.45 mm), 4" or 8" D (100 mm or 200 mm) and 19" W
- Mounting hardware not included; supports up to 30 lb (13.6 kg) load

Part Number	Description	Shipping Weight lb (kg)
11521-X04	3.50 (88.9), 2U High, 4 (100) Deep	2 (0.9)
11522-X04	5.25 (133.4), 3U High, 4 (100) Deep	2 (0.9)
11523-X04	7.00 (177.8), 4U High, 4 (100) Deep	2 (0.9)
11524-X04	8.75 (222.3), 5U High, 4 (100) Deep	2 (0.9)
11525-X04	10.5 (267.0), 6U High, 4 (100) Deep	2 (0.9)
11520-001	Hinges, Pair	1 (0.5)

X=color: 1=Gray, 5=Clear, 7=Black, E=Glacier White
Also available in 8" D (200 mm), (-X08).



30015-X00



30016-X00



Block Mounting Bar, Rack-Mounted

For mounting terminal blocks, card files and other equipment on 19" and 23" racks.

- Angle mounting bars are 1/8" (3.18 mm) cold-rolled steel
- T-mounting bars are 1/8" (3.18 mm) extruded aluminum
- Hole patterns are 12-24 tapped on 7/16" (11.113 mm) centers
- Supports 66/89 Blocks; sold individually

Part Number	Description	Shipping Weight lb (kg)
30013-X00	19" Angle	2 (0.9)
30014-X00	23" Angle	2 (0.9)
30015-X00	19" T-Bar	2 (0.9)
30016-X00	23" T-Bar	2 (0.9)

X=color: 1=Gray, 5=Clear, 7=Black, E=Glacier White

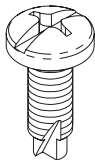

40605-00X

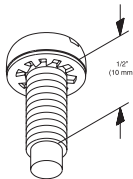
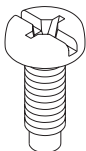

40606-001

Combination Pan Head, Pilot Point, Mounting Screws

- Available in choice of Zinc plated or Black finish in packages of 50 and 1000
- The 40606 Combination Pan Head, Pilot Point, Sems Mounting Screws are similar to the 40605, except includes captive lock washer; Zinc plated finish

Part Number	Nominal Size	Package	Of	Shipping Weight lb (kg)
40605-001	12-24	50		1 (0.5)
40605-004	12-24	1000		9 (4.1)
40605-005	12-24 (Black)	50		1 (0.5)
40605-006	12-24 (Black)	1000		9 (4.1)
40606-001	12-24	50		1 (0.5)

Heavy-Duty Wall-Mount Equipment Rack

Use the Heavy Duty Wall-Mount Equipment Rack to hold up to 350 lb (158.8 kg). The 24"D (610 mm) allows larger equipment to be wall-mounted. Quick and easy assembly has been engineered in to save you valuable installation time. Includes assembly hardware and mounting 1/4" x 2" lag bolts. Sold individually.

- 12-24 roll-formed threads on 5/8"-5/8"-1/2" (15.9 mm -15.9 mm -12.7 mm) spacing, both sides
- U spaces are marked and numbered
- Made of high-strength, lightweight aluminum
- Includes (50) #12-24 mounting screws. Black painted racks ship with black screws; other racks ship with zinc screws
- Holds up to 350 lb (158.8 kg) when securely mounted to wall or backboard



Heavy-Duty Wall-Mount Equipment Rack							
Part Number	Height	Width	Depth	Height	Width	Depth	Shipping Weight lb (kg)
	Usable Dimensions			Overall Dimensions			
15320-X18	20U	19"EIA	18 (457)	41.2 (1046)	23.0 (584)	18.0 (457)	22 (10.0)
15320-X24	20U	19"EIA	24 (610)	41.2 (1046)	23.0 (584)	24.0 (610)	27 (12.2)
15321-X18	40U	19"EIA	18 (457)	76.2 (1935)	23.0 (584)	18.0 (457)	28 (12.7)
15321-X24	40U	19"EIA	24 (610)	76.2 (1935)	23.0 (584)	24.0 (610)	32 (14.5)
15322-X18	20U	23"	18 (457)	41.2 (1046)	27.0 (686)	18.0 (457)	23 (10.4)
15322-X24	20U	23"	24 (610)	41.2 (1046)	27.0 (686)	24.0 (610)	29 (13.2)
15323-X18	40U	23"	18 (457)	76.2 (1935)	27.0 (686)	18.0 (457)	29 (13.2)
15323-X24	40U	23"	24 (610)	76.2 (1935)	27.0 (686)	24.0 (610)	34 (15.4)

X=Color: 1=Gray, 5=Clear, 7=Black, E=Glacier White



11583-XXX

Flush-Mounted Wall Bracket

Use the Flush-Mounted Wall Bracket to mount up to 6U of rack-mounted equipment, vertically, and flush to a wall. Ideal for areas where space is limited. The bracket has square-punched mounting rails and includes a pack of 25 Clik-Nut. Supports 150 lb (68 kg). Wall mounting hardware not included.

Part Number	Description
11583-X19	3U x 19", Flush-Mounted Bracket
11754-X19	6U x 19", Flush-Mounted Bracket

X=Color: 1=Gray, 7=Black, E=Glacier White

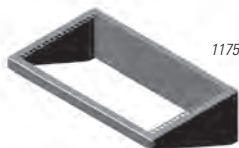

11754-XXX



Ships flat



EasySwing Wall-Mount Rack

The EasySwing Wall-Mount Rack is a cost-effective 19" EIA swing gate rack for mounting network, communications and security equipment in a telecommunications or equipment room where floor space is limited.

- Opens 180° to right or left, locking latch pin secures gate in closed position. Includes lanyard for attachment to rack
- 19" EIA threaded equipment mounting rails
- Includes reusable cable management straps
- Durable all-steel construction
- Ships fully assembled and flat; simply unfold and mount to wall
- Keyhole wall mounting holes with mounting template included on carton
- Includes (12) #12-24 equipment mounting screws. Order 1/4" installation hardware separately
- Supports 85 lb (38.6 kg) of equipment

Easy Swing Wall-Mount Rackk							
Part Number	Height	Width	Depth	Height	Width	Depth	Shipping Weight lb (kg)
				Usable Dimensions			
13602-X08	11U	19"EIA	6.5 (165)	24.5 (622)	20.3 (516)	8.0 (204)	22 (10.0)
13602-X12	11U	19"EIA	10.5 (266)	24.5 (622)	20.3 (516)	12.0 (305)	24 (10.9)
13602-X18	11U	19"EIA	16.5 (419)	24.5 (622)	20.3 (516)	18.0 (457)	28 (12.7)
13602-X25	11U	19"EIA	23.5 (596)	24.5 (622)	20.3 (516)	25.0 (635)	34 (15.4)
13604-X08	19U	19"EIA	6.5 (165)	38.5 (978)	20.3 (516)	8.0 (204)	27 (12.2)
13604-X12	19U	19"EIA	10.5 (266)	38.5 (978)	20.3 (516)	12.0 (305)	29 (13.2)
13604-X18	19U	19"EIA	16.5 (419)	38.5 (978)	20.3 (516)	18.0 (457)	33 (15.0)
13604-X25	19U	19"EIA	23.5 (596)	38.5 (978)	20.3 (516)	25.0 (635)	38 (17.2)
13608-X12	26U	19"EIA	10.5 (266)	51.5 (1308)	20.3 (516)	12.0 (305)	33 (15.0)
13608-X18	26U	19"EIA	16.5 (419)	51.5 (1308)	20.3 (516)	18.0 (457)	37 (16.8)

*X=*color: 1=Gray, 7=Black, E=Glacier White

Note: Usable depth is reduced at the top and bottom 2U on -X08 and -X12 models and at the top and bottom 3U on -X18 and -X25 models. For planning purposes, reduce usable depth by 75% and 50% on the top and bottom 2U of -X08 and -X12 racks. Reduce usable depth by 80%, 50% and 25% on the top and bottom 3U of -X18 and -X25 racks.

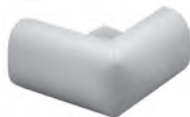

Includes double-sided adhesive squares for easy installation

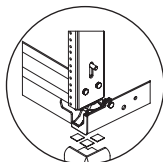

Corner Cushions

Since wall racks are elevated above the floor and extend away from the wall, bumping into the rack is a safety concern. Corner Cushions cover the exposed leading edges of racks for added protection.

- Flame retardant, non-toxic
- Foam design conforms to ASTM standards for safety surfacing material

Part Number	Description	Shipping Weight lb (kg)
12858-001	Corner Cushions, Set of 4	1 (0.5)



Standard Swing Gate Wall Rack

The Standard Swing Gate Wall Rack provides easy access to the rear of equipment, making it the ideal choice for supporting patch panels and switches.

- Dual hinges open to right or left, stopping in 90° position
- EIA-310 compliant
- Universal 5/8"-5/8"-1/2" (15.9 mm -15.9 mm -12.7 mm) alternating hole pattern
- Rack-mount spaces are marked and numbered
- Includes (50) #12-24 mounting screws.
- Supports 100 lb (45.4 kg) of equipment in the open and closed position
- Load capacity can be increased to 150 lb (68 kg) with optional Heavy Duty Kit
- Supports single-sided and double-side shelves
- Ships partially assembled with installation hardware

Standard Swing Gate Wall Rack							
Part Number	Height	Width	Depth	Height	Width	Depth	Shipping Weight lb (kg)
	Usable Dimensions			Overall Dimensions			
11790-X12	12U	19"EIA	11 (280)	29.1 (739)	21.7 (551)	12.2 (310)	22 (10.0)
11790-X18	12U	19"EIA	17 (430)	29.1 (739)	21.7 (551)	18.2 (462)	24 (10.9)
11790-X25	12U	19"EIA	24 (610)	29.1 (739)	21.7 (551)	25.2 (640)	42 (19.1)
11791-X12	20U	19"EIA	11 (280)	43.1 (1095)	21.7 (551)	12.2 (310)	24 (10.9)
11791-X18	20U	19"EIA	17 (430)	43.1 (1095)	21.7 (551)	18.2 (462)	26 (11.8)
11791-X25	20U	19"EIA	24 (610)	43.1 (1095)	21.7 (551)	25.2 (640)	46 (20.9)
11807-X12	26U	19"EIA	11 (280)	53.6 (1361)	21.7 (551)	12.2 (310)	25 (11.3)
11807-X18	26U	19"EIA	17 (430)	53.6 (1361)	21.7 (551)	18.2 (462)	26 (11.8)
11807-X25	26U	19"EIA	24 (610)	53.6 (1361)	21.7 (551)	25.2 (640)	50 (22.7)
11792-X12	40U	19"EIA	11 (280)	78.1 (1984)	21.7 (551)	12.2 (310)	31 (14.1)
11792-X18	40U	19"EIA	17 (430)	78.1 (1984)	21.7 (551)	18.2 (462)	33 (15.0)
11792-X25	40U	19"EIA	24 (610)	78.1 (1984)	21.7 (551)	25.2 (640)	60 (27.2)
11793-X12	12U	23"	11 (280)	29.1 (739)	25.7 (653)	12.2 (310)	23 (10.4)
11793-X18	12U	23"	17 (430)	29.1 (739)	25.7 (653)	18.2 (462)	25 (11.3)
11793-X25	12U	23"	24 (610)	29.1 (739)	25.7 (653)	25.2 (640)	43 (19.5)
11794-X12	20U	23"	11 (280)	43.1 (1095)	25.7 (653)	12.2 (310)	25 (11.3)
11794-X18	20U	23"	17 (430)	43.1 (1095)	25.7 (653)	18.2 (462)	27 (12.2)
11794-X25	20U	23"	24 (610)	43.1 (1095)	25.7 (653)	25.2 (640)	47 (21.3)
11808-X12	26U	23"	11 (280)	53.6 (1361)	25.7 (653)	12.2 (310)	26 (11.8)
11808-X18	26U	23"	17 (430)	53.6 (1361)	25.7 (653)	18.2 (462)	28 (12.7)
11808-X25	26U	23"	24 (610)	53.6 (1361)	25.7 (653)	25.2 (640)	51 (23.1)
11795-X12	40U	23"	11 (280)	78.1 (1984)	25.7 (653)	12.2 (310)	32 (14.5)
11795-X18	40U	23"	17 (430)	78.1 (1984)	25.7 (653)	18.2 (462)	34 (15.4)
11795-X25	40U	23"	24 (610)	78.1 (1984)	25.7 (653)	25.2 (640)	61 (27.7)

X=color: 1=Gray, 7=Black, E=Glacier White

Note: Usable depth is reduced at the top and bottom U to 8" (200 mm) on -X12; 12" (300 mm) on -X18; and 19" (462 mm) on -X25 racks.



Heavy Duty Swing Gate Kit increases the load bearing capacity of P/Ns (-X18) and (-X25) Standard Swing Gate Wall Racks to 150 lb (68 kg). Hardware included.

Part Number	Description	Shipping Weight lb (kg)
12795-X01	Heavy Duty Swing Gate Kit, 2 Brackets	4 (1.8)

X=color: 1=Gray, 7=Black, E=Glacier White.



Fixed Wall-Mount Equipment Rack

The Fixed Wall-Mount Equipment Rack is a sturdy platform for wall mounting equipment.

- U spaces are marked and numbered, tapped with #12-24 roll-formed threads
- Includes (50) #12-24 equipment mounting screws. Black painted racks ship with black screws; other racks ship with zinc screws
- Supports single-sided and double-sided shelves
- Supports 200 lb (90.7 kg) of equipment when securely mounted to wall or backboard using all eight leg mounting holes

Fixed Wall-Mount Equipment Rack							
Part Number	Height	Width	Depth	Height	Width	Depth	Shipping Weight lb (kg)
	Usable Dimensions			Overall Dimensions			
11960-X06	12U	19"EIA	6 (150)	27.4 (696)	22.4 (569)	6.6 (168)	9 (4.1)
11960-X12	12U	19"EIA	12 (300)	27.4 (696)	22.4 (569)	12.6 (320)	12 (5.4)
11960-X18	12U	19"EIA	18 (457)	27.4 (696)	22.4 (569)	18.6 (472)	13 (5.9)
11961-X06	20U	19"EIA	6 (150)	41.4 (1052)	22.4 (569)	6.6 (168)	10 (4.5)
11961-X12	20U	19"EIA	12 (300)	41.4 (1052)	22.4 (569)	12.6 (320)	13 (5.9)
11961-X18	20U	19"EIA	18 (457)	41.4 (1052)	22.4 (569)	18.6 (472)	15 (6.8)
11962-X06	40U	19"EIA	6 (150)	76.4 (1941)	22.4 (569)	6.6 (168)	15 (6.8)
11962-X12	40U	19"EIA	12 (300)	76.4 (1941)	22.4 (569)	12.6 (320)	16 (7.3)
11962-X18	40U	19"EIA	18 (457)	76.4 (1941)	22.4 (569)	18.6 (472)	20 (9.1)
11963-X06	12U	23"	6 (150)	27.4 (696)	26.4 (671)	6.6 (168)	10 (4.5)
11963-X12	12U	23"	12 (300)	27.4 (696)	26.4 (671)	12.6 (320)	11 (5.0)
11963-X18	12U	23"	18 (457)	27.4 (696)	26.4 (671)	18.6 (472)	13 (5.9)
11964-X06	20U	23"	6 (150)	41.4 (1052)	26.4 (671)	6.6 (168)	11 (5.0)
11964-X12	20U	23"	12 (300)	41.4 (1052)	26.4 (671)	12.6 (320)	12 (5.4)
11964-X18	20U	23"	18 (457)	41.4 (1052)	26.4 (671)	18.6 (472)	15 (6.8)
11965-X06	40U	23"	6 (150)	76.4 (1941)	26.4 (671)	6.6 (168)	16 (7.3)
11965-X12	40U	23"	12 (300)	76.4 (1941)	26.4 (671)	12.6 (320)	17 (7.7)
11965-X18	40U	23"	18 (457)	76.4 (1941)	26.4 (671)	18.6 (472)	19 (8.6)

X=color: 1=Gray, 5=Clear, 7=Black, E=Glacier White

Hinged Panel Mounting Bracket

Provides easy access to back of wall or rack-mounted panels.

- 1.75" H (44.45 mm), 4" or 8" D (100 mm or 200 mm) and 19" W
- Mounting hardware not included; supports up to 30 lb (13.6 kg) load

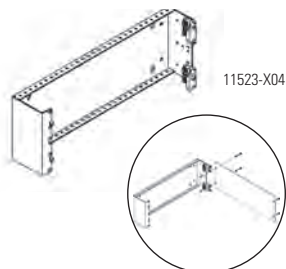

Part Number	Description in (mm)	Shipping Weight lb (kg)
11521-X04	3.50 (88.9), 2U High, 4 (100) Deep	2 (0.9)
11522-X04	5.25 (133.4), 3U High, 4 (100) Deep	2 (0.9)
11523-X04	7.00 (177.8), 4U High, 4 (100) Deep	2 (0.9)
11524-X04	8.75 (222.3), 5U High, 4 (100) Deep	2 (0.9)
11525-X04	10.5 (267.0), 6U High, 4 (100) Deep	2 (0.9)

X=color: 1=Gray, 5=Clear, 7=Black, E=Glacier White
Also available in 8" D (200 mm), (-X08).

2U

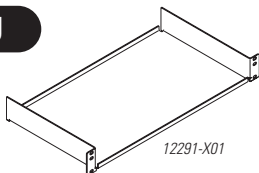

3U

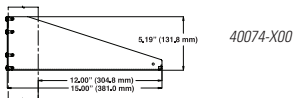
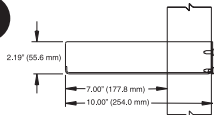

Shelves

- 15" (380 mm) shelf mounts in 18"D (460 mm) racks only

Part Number	Description	Shipping Weight lb (kg)
10"D (250 mm) Shelf, H x W - in (mm)		
12291-X01	2U x 17.25 (438.2), Supports 40 lb (18.1 kg)	4 (1.8)
15"D (380 mm) Shelf, H x W - in (mm)		
40074-X00	3U x 17.25 (438.2), Supports 50 lb (22.7 kg)	6 (2.7)

X=color: 1=Gray, 5=Clear, 7=Black, E=Glacier White



1U



Power Strip

Streamlined, durable steel body is fitted with bracket for mounting.

- 17"L (430 mm), uses 1U, black
- Circuit breaker, six or eight outlets, non-surge or surge-protected, 10'L (3 m) cord

Part Number	AMP	Plug Type	Outlets	Surge Protected
12816-701	15A	NEMA 5-15P	(8) 5-15R	No
12816-702	15A	NEMA L5-15P	(8) 5-15R	No
12816-703	15A	NEMA 5-15P	(6) 5-15R	Yes
12816-704	15A	NEMA L5-15P	(6) 5-15R	Yes
12816-705	20A	NEMA 5-20P	(8) 5-20R	No
12816-706	20A	NEMA L5-20P	(8) 5-20R	No
12816-707	20A	NEMA 5-20P	(6) 5-20R	Yes
12816-708	20A	NEMA L5-20P	(6) 5-20R	Yes

PATENTED



Motive Horizontal Cable Managers also available to complement the styling of the Motive Vertical Cable Managers.

Motive® Cable Management

Motive Vertical Cable Manager is a highly configurable and advanced cable management solution that provides unlimited adjustability anywhere within the cable manager, optimizing use of interior space.

Motive Vertical Cable Management features an extrusion-based central track system and includes four tool-less cable management accessories. The unique design of the accessories provide numerous cable segregation configurations that allow for direct support of cables with optimal airflow through the cable manager, preparing networks for higher wattage in Power over Ethernet (PoE).

Tool-less Accessories in Motive Vertical Cable Manager include:

- Accessory Rod mounts to Motive's central track, feature tool-less vertical adjustment and serves as the foundation for all of Motive's cable management accessories
- Rotating Management Finger accessory attaches to the Accessory Rod and provides cable bundle support and bundle segregation at any point within the cable manager
- Cable Bundle Swivel accessory attaches directly to Motive's central track, Accessory Rod or Rotating Management Finger and allows for quick attachment, removal and adjustment of cable bundles
- Half Spool accessory snaps onto the Accessory Rod and provides slack management and bend support for cables

Whether in a small telecommunications room closet or in a large scale enterprise data center, Motive's superior form and functions provide quick and easy moves, add, and changes through intuitive design and tool-less adjustability.

Features:

- Frame has an extruded aluminum profile with a central track
- Innovative, tool-less accessories are included
- Large radii are designed into many of the frame elements to protect and support cables as they enter and exit the manager
- Touch points are highlighted in blue for easy identification and quick adjustment
- Dual-hinged door opens to the right or left and offers push-to-close convenience
- Hinge and latch design allows for quick removal and attachment of door for easy access to cables
- Hook feature on inside of front door provides a dedicated, secure location to hang a test meter
- Available in a wide variety of heights, widths and configurations

Motive Horizontal Cable Managers complements the styling of the Motive Vertical Cable Manager and provides a dedicated horizontal pathway to organize and store cables above patch panels and network switches.

- Available in four heights; 1U, 2U, 3U, 4U
- Contoured, snap-on front door opens up or down and complements the styling of Motive Vertical Cable Manager
- 2 chassis styles; solid or with cable pass-through ports
- Plastic T-shaped cable guides organize cables as they enter and exit the manager

Motive Ordering Matrix:

Choose Manager **Style**, **Width**, **Color**, and **Height**, **Example Cable Manager Part Number: 326XX-XXX**

3	2	6	Style	Width - in (mm)	-	Color	Height - ft/in (m)
	1		Single-Sided	0 6 (150)		7 Black	01 6' (1.8)
	2		Double-Sided	1 8 (200)		E Glacier White	02 6'6" (2.0)
				2 10 (250)			03 7' (2.1)
				3 12 (300)			05 7'6" (2.3)
				4 15 (380)			15 8' (2.4)
							08 9' (2.7)

*Motive Vertical Cable Manager ships partially assembled.
Assembly is quick and simple, requiring the installation of eight screws.*

PATENTED



Accessories included with Motive Vertical Cable Manager:

Single-Sided Managers Include:

- Left and right side assemblies with T-shaped cable guides that align with rack-mount unit (U) spaces on rack
- Dual-hinged front door assembly
- Central track assembly
- 2 Accessory Rods
- 4 Rotating Management Fingers (Not included in 6"W (150 mm) and 8"W (200 mm))
- 12 Cable Bundle Swivels
- 4 Half Spools (Not included in 6"W (150 mm) and 8"W (200 mm))
- Installation and assembly hardware

Double-Sided Managers Include:

- Left and right side assemblies with T-shaped cable guides that align with rack-mount unit (U) spaces on rack
- Dual-hinged front door and rear door assemblies
- Central track assembly
- 4 Accessory Rods
- 4 Rotating Management Fingers (Not included in 6"W (150 mm) and 8"W (200 mm))
- 12 Cable Bundle Swivels
- 4 Half Spools (Not included in 6"W (150 mm) and 8"W (200 mm))
- Installation and assembly hardware

PATENTED



Accessory Rod Assembly

Accessory Rod Assembly hooks onto the central track at any point and features a T-slot extrusion on each side for attaching accessories and a thumb screw for quick adjustment.

- T-slot tracks on right and left sides
- Use for left and right cable segregation and with other accessories for a variety of configurations
- Adjust elevation by loosening and retightening of blue thumbscrew
- Sold in pairs
- Finish: Clear anodized aluminum with black base and end cap; blue adjustment point

Part Number	Description	Shipping Weight lb (kg)
32650-701	For Motive Single-Sided Vertical Cable Manager, 1 pair	2 (0.7)
32650-702	For Motive Double-Sided Vertical Cable Manager, 1 pair	2 (0.7)

See Cable Fill Tables at chatsworth.com/cablefill

PATENTED



Rotating Management Finger Kit

Rotating Management Finger Kit positions anywhere front-to-back along the Accessory Rod Assembly to secure and isolate cable bundles. It rotates and locks into position in 45 degree increments on the Accessory Rod Assembly for flexible cable support anywhere within the manager (Not for use with 6"W (150 mm) and 8"W (200 mm) managers).

- Attaches to the Accessory Rod using tool-less clasp-type fastener
- Accommodates up to 4 Cable Bundle Swivels
- Use for cable bundle segregation and to support cables anywhere within cable management space
- Sold in packs of 4
- Finish: Black with blue adjustment point

Part Number	Description	Shipping Weight lb (kg)
32661-001	Rotating Management Finger Kit, Pack of 4	1 (0.5)

PATENTED



Cable Bundle Swivel Kit

Cable Bundle Swivel Kit can be used anywhere on the central track or Accessory Rod Assembly, as well as multiple points on the Rotating Management Finger.

- Tool-less 1/4 turn installation
- Swivel feature adds flexibility and enhances cable bundle support
- Accommodates hook and loop fasteners up to 3/4"W (19 mm)
- Available in packs of 12 or 48
- Finish: Black with blue adjustment point

Part Number	Description	Shipping Weight lb (kg)
32657-001	Cable Bundle Swivel Kit, Pack of 12	1 (0.5)
32657-002	Cable Bundle Swivel Kit, Pack of 48	2 (0.9)

PATENTED



Half Spool Kit

Half Spool Kit attaches to the Accessory Rod Assembly. Half Spools can be used over and under to create a complete round spool or front/rear to create two half spools. (Not for use with 6"W (150 mm) and 8"W (200 mm) managers).

- Tool-less installation – snaps onto Accessory Rod Assembly
- Adjusts front-to-rear
- Installs on top and bottom of Accessory Rod Assembly to create a full 2" diameter (50 mm) spool
- Use up to 4 Half Spools per Accessory Rod Assembly
- Sold in a pack of 4
- Finish: Black

Part Number	Description	Shipping Weight lb (kg)
32651-001	Half Spool Kit, Pack of 4	1 (0.5)



Cable Ring Kit for Motive Single-Sided Vertical Cable Manager

- Creates a separate cable pathway for premise cables at the back of Motive Single-Sided Vertical Cable Manager
- Match the kit to the width of the vertical cable manager; one kit per manager
- Attaches to the central track with included hardware
- Rings are C-shaped, 3.5"H x 8.5"D (89 mm x 216 mm), with a plastic latch that spins open to provide access to cables
- Compatible with all Motive Cable Management accessories
- Each kit includes 5 rings

Part Number	Description	Shipping Weight lb (kg)
32573-X00	For 6"W (150 mm) Manager	9.6 (4.4)
32573-X01	For 8"W (200 mm) Manager	11 (5.5)
32573-X02	For 10"W (250 mm) Manager	12.4 (5.6)
32573-X03	For 12"W (300 mm) Manager	14.8 (6.7)
32573-X04	For 15"W (380 mm) Manager	17.8 (8.1)

X= Color; 7 = Black, E= Glacier White.



Tool-less Bend Radius Kit for Fiber Patch Cords

Tool-less Bend Radius Kit for Fiber Patch Cords ensures proper bend radius support for fiber optic patch cords when transitioning through T-shaped cable guides. It snaps onto the finger manager without any tools, and can be used for new or retrofit applications.

- Provides proper bend radius support for fiber optic patch cords
- Tool-less installation
- May be installed in upward or downward orientations on either side of a T-shaped cable guide
- Compatible with Evolution, Motive Cable Management and N-Series TeraFrame Gen 3 Network Cabinet System.
- Also compatible with accessory cable management finder kits for SeismicFrame Two-Post Rack, Adjustable Rail QuadraRack and Adjustable Rail ServerRack (see P/N 13696-00X and 15286-0XX respectively)
- Available in packs of 10 or 50

Part Number	Description	Shipping Weight lb (kg)
32697-001	Tool-less Bend Radius Kit for Fiber Patch Cords, Pack of 10	1 (0.5)
32697-002	Tool-less Bend Radius Kit for Fiber Patch Cords, Pack of 50	3 (1.4)

PATENTED

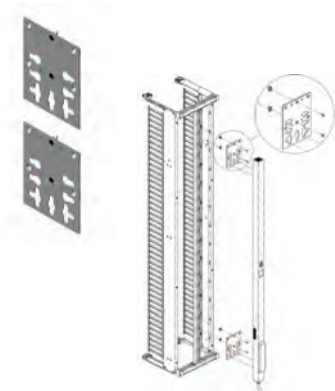

Dual PDU Bracket Kit

Dual PDU Bracket Kit attaches directly to Motive's central track and provides a flexible and convenient method of supporting up to two vertical PDUs side-by-side.

- 2-piece design enables compatibility with virtually all tool-less PDU chassis lengths
- Attaches directly to the central track of the manager
- Center-mount on any manager width
- Optional offset mount on 10"W (250 mm) and wider managers
- Supports two 2.7"W (69 mm) or narrower PDUs side-by-side or one 4"W (100 mm PDU)

Part Number	Description	Shipping Weight lb (kg)
32601-X00	Dual PDU Bracket Kit	2 (0.9)

X= Color, 7 = Black, E= Glacier White. (Note: Cable manager must be taller than PDU).

PATENTED

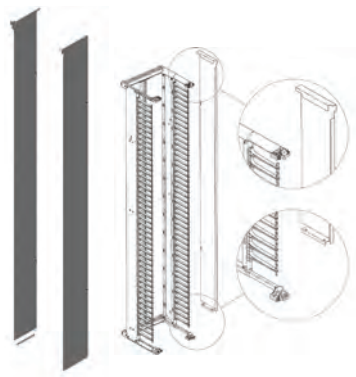

Side Panel Kit

- Use for added protection and/or in thermal containment environments
- Available in 1 pair or 2 pairs
- 1 pair includes 1 left and 1 right side panel and will cover both sides of a Motive Single-Sided Vertical Cable Manager
- 2 pairs includes 2 left and 2 right side panels and will cover both sides of a Motive Double-Sided Vertical Cable Manager

Part Number	Description	Shipping Weight lb (kg)
32602-X03	84 (2133), 1 Pair	16 (7.3)
32602-X53	84 (2133), 2 Pairs	30 (13.6)

X= Color, 7 = Black, E= Glacier White. Side Panel Kit is available for all standard heights and widths. See Motive Data Sheet for additional information.

PATENTED



35431-X02



35432-X02

Motive Horizontal Cable Manager

Motive Horizontal Cable Manager complements the styling of the Motive Vertical Cable Manager and provides a dedicated horizontal pathway to organize and store cables above patch panels and network switches.

Motive Horizontal Cable Manager includes plastic T-shaped cable guides to organize patch cords and jumper cords as the cords enter and exit the manager to make individual equipment connections. Two chassis styles are available. Choose the solid chassis option for use in areas where thermal isolation is needed. Use the chassis with pass-through cable ports to allow patch cords to pass front-to-rear.

- Available in four heights; 1U, 2U, 3U, 4U
- Contoured, snap-on front door opens up or down and complements the styling of Motive Vertical Cable Manager
- 2 chassis styles; solid or with cable pass-through ports
- Plastic T-shaped cable guides organize cables as they enter and exit the manager

Part Number		Height (U)	Shipping Weight lb (kg)
Dual	Wide		
35431-X02	With cable pass-through ports	2U x 19 x 8.2 (208)	4 (1.8)
35431-X03	With cable pass-through ports	3U x 19 x 8.2 (208)	5 (2.4)
35431-X04	With cable pass-through ports	4U x 19 x 8.2 (208)	7 (3.2)
35432-X01	Solid	1U x 19 x 8.2 (208)	3 (1.4)
35432-X02	Solid	2U x 19 x 8.2 (208)	4 (1.8)
35432-X03	Solid	3U x 19 x 8.2 (208)	5 (2.4)
35432-X04	Solid	4U x 19 x 8.2 (208)	7 (3.2)

X=Color; 7=Black and E=Glacier White. 1U Horizontal managers available with solid chassis only.

PATENTED

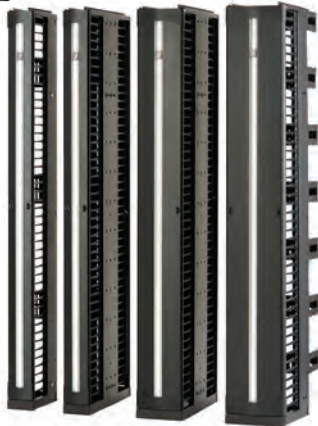

Evolution Horizontal Cable Managers also available to complement the styling of the Motive Vertical Cable Managers.

Evolution® Cable Management

CPI Evolution Cable Management provides an engineered solution for managing high-density cabling applications on open two-post and four-post CPI Rack Systems.

Evolution Vertical Cable Manager:

Use vertical managers on the sides of racks to manage premise cables, patch cords and jumper cords. Vertical managers include plastic T-shaped cable guides with openings that align with each rack-mount unit space on the rack. Rounded edges on the cable guides and the top of the manager protect cables as they enter or exit the interior storage space. On double-sided managers, Movable Mid-Sections allow personalized placement of Cable Distribution Spools and other cable management accessories to effectively route patch cords.

Features:

- Improved T-shaped cable guides decrease deflection when loaded with cables, especially important when deploying Cat 6a cable
- Rounded edges on the cable guides protect cables as they enter and exit the storage space
- Door opens to the right or left with a single knob
- Rigid trough minimizes movement when installed on the end of a row of racks; solid construction with a full rectangular base supports large bundles of heavy cables
- Openings in the back of the single-sided and middle of the double-sided managers allow cables to easily pass from front-to-rear
- Double-sided managers have Movable Mid-Sections that allow for flexibility in the volume of cable management space provided in the front and rear portions of the cable manager
- Various cable management accessories are available to divide the interior space and manage cable slack

PATENTED



Single-Sided Vertical Cable Manager also available in 6'H (1.8 m) and 8'H (2.4 m)

Evolution Single-Sided Vertical Cable Manager

- Rigid cable manager with 1U spaced plastic T-shaped cable guides (fingers)
- Three Fixed Accessory Panels at the back of the cable manager
- Three large Cable Distribution Spools included with 10", 12" and 15" (250 mm, 300 mm and 380 mm) wide managers

Part Number		7'H (2.1 m) W x D - in (mm)	Shipping Weight lb (kg)
Black	Glacier White		
35511-703	35511-E03	6 x 13.2 (150 x 335)	57 (25.9)
35512-703	35512-E03	8 x 13.2 (200 x 335)	61 (27.7)
35513-703	35513-E03	10 x 13.2 (250 x 335)	67 (30.4)
35514-703	35514-E03	12 x 13.2 (300 x 335)	73 (33.1)
35515-703	35515-E03	15 x 13.2 (380 x 335)	83 (37.6)

PATENTED



Double-Sided Vertical Cable Manager also available in 6'H (1.8 m) and 8'H (2.4 m)

Evolution Double-Sided Vertical Cable Manager

- Rigid cable manager with 1U spaced plastic T-shaped cable guides (fingers)
- Three Movable Mid-Sections; creates 50/50, 60/40 or 40/60 interior split
- Three large Cable Distribution Spools included with 10", 12" and 15" (250 mm, 300 mm and 380 mm) wide managers

Part Number		7'H (2.1 m) W x D - in (mm)	Shipping Weight lb (kg)
Black	Glacier White		
35521-703	35521-E03	6 x 24.5 (150 x 622)	94 (42.6)
35522-703	35522-E03	8 x 24.5 (200 x 622)	101 (45.8)
35523-703	35523-E03	10 x 24.5 (250 x 622)	110 (49.9)
35524-703	35524-E03	12 x 24.5 (300 x 622)	118 (53.5)
35525-703	35525-E03	15 x 24.5 (380 x 622)	129 (58.5)

PATENTED



Combination Vertical Cable Manager also available in 6'H (1.8 m) and 8'H (2.4 m)

Evolution Combination Vertical Cable Manager

Rear Cable Rings with spin-open latches on back (no door/cover)

- Three large Cable Distribution Spools included with 10", 12" and 15" (250 mm, 300 mm and 380 mm) wide managers

Part Number		7'H (2.1 m) W x D - in (mm)	Shipping Weight lb (kg)
Black	Glacier White		
35571-703	35571-E03	6 x 20.2 (150 x 513)	68 (30.8)
35572-703	35572-E03	8 x 20.2 (200 x 513)	72 (32.7)
35573-703	35573-E03	10 x 20.2 (250 x 513)	78 (35.4)
35574-703	35574-E03	12 x 20.2 (300 x 513)	84 (38.1)
35575-703	35575-E03	15 x 20.2 (380 x 513)	94 (42.6)

PATENTED



35475-701

PATENTED



35473-001

PATENTED



35503-701



32697-701

See Cable Fill Tables at chatsworth.com/cablefill

Evolution Cable Management Accessories

Fiber Segregation Kit

Creates a pathway for fiber cables and patch cords; the number of kits allowed per manager depends on the position of the Movable Mid-Section and the width of the vertical cable manager (see table). Each kit includes two 20.5" H (521 mm) J-shaped steel mounting brackets, eight plastic Fiber Segregation Spools and mounting hardware. The Fiber Segregation Spools turn 360° with stops at 90°, allowing easy access to fiber cables. The assembled bracket is 3.8" W x 4.3" D (97 mm x 109 mm) and includes mounting hardware.

Cable Manager Width- in (mm)	Double-Sided with 60/40 Front/Rear Split (60% per side)	Single-Sided and all other Double-Sided positions
6 (150)	1	0
8 (200)	1	1
10 (250)	2	1
12 (300)	2	2
15 (380)	2	2

Cable Lashing Bar Kit

Provides tie points for cables inside Evolution Vertical Managers. Use up to six cable lashing bars (front/rear) in 6"W (150 mm) vertical cable managers and up to ten (front/rear) in the 8"W (200 mm), 10"W (250 mm), 12"W (300 mm) and 15"W (380 mm) vertical cable managers. Each kit includes four round .23" (5.7 mm) diameter 20.6" L (524 mm) steel lashing bars and mounting hardware.

Cable Divider Bar Kit

Provides tie points for cables and divides the interior of the cable manager to create multiple pathways for cables. Each kit includes four Cable Divider Bars, 5.75" H x 1" W x 20" L (146 mm x 25 mm x 510 mm) and mounting hardware. Divider Bars are welded steel construction consisting of a vertical cable lashing bar and two U-shaped cable dividers. Use side-by-side to create multiple pathways in 10"W (250 mm) or wider cable managers.

Tool-less Bend Radius Kit for Fiber Patch Cords

Ensures proper bend radius support for fiber optic patch cords when transitioning through T-shaped cable guides. It snaps onto the finger manager without any tools, and can be used for new or retrofit applications.

- Compatible with Evolution, Motive Cable Management and N-Series TeraFrame Gen 3 Network Cabinet System.
- Also compatible with accessory cable management finger kits for SeismicFrame Two-Post Rack, Adjustable Rail QuadraRack and Adjustable Rail ServerRack see P/N 13696-00X and 15286-00X, respectively)

Part Number	Description	Shipping Weight lb (kg)
35475-701	Fiber Segregation Kit, Black	6 (2.7)
35473-001	Cable Lashing Bar Kit, Zinc	2 (0.9)
35503-701	Cable Divider Bar Kit, Black	3 (1.4)
32697-001	Tool-less Bend Radius Kit, Pack of 10	1 (0.5)
32697-002	Tool-less Bend Radius Kit, Pack of 50	3 (1.4)

Evolution Cable Management Accessories

Solid Rear Panel

Encloses the rear of the Evolution g1 Single-Sided Vertical Cable Manager. Hangs from the top of the manager or attaches to the back of the Fixed Accessory Panels. Sold individually or in pairs; includes hardware.

Solid Mid Panel

Covers and divides the front and rear of the Evolution g2 Double-Sided Vertical Cable Manager. Attaches to the back of the Movable Mid-Sections inside the manager. Includes one Moveable Mid-Section for 7'H (2.1m) manager and two for 8'H (1.8 m) manager. Sold individually or in packs of four; includes hardware.

Solid Side Panel

Covers the side of an Evolution g2 Double-Sided Vertical Cable Manager located at the end of a row of equipment racks. Easy tool-less installation; hangs from the top of the manager and attaches at the bottom of the manager with included snap-in hardware. Sold individually or in pairs.

PATENTED



35501-X02

PATENTED



35497-X02

PATENTED



35502-X02

Part Number	Description Height - 7'H (2.1 m) Width - in (mm)	Shipping Weight lb (kg)
35501-X02	Solid Rear Panel, 6 (150), Each	11 (5.0)
35501-X05	Solid Rear Panel, 8 (200), Each	11 (5.0)
35501-X08	Solid Rear Panel, 10 (250), Each	11 (5.0)
35501-X11	Solid Rear Panel, 12 (300), Each	11 (5.0)
35501-X14	Solid Rear Panel, 15 (380), Each	11 (5.0)
35501-X52	Solid Rear Panel, 6 (150), Pair	42 (19.1)
35501-X55	Solid Rear Panel, 8 (200), Pair	42 (19.1)
35501-X58	Solid Rear Panel, 10 (250), Pair	42 (19.1)
35501-X61	Solid Rear Panel, 12 (300), Pair	42 (19.1)
35501-X64	Solid Rear Panel, 15 (380), Pair	42 (19.1)
35497-X02	Solid Mid Panel, 6 (150), Each	16 (7.3)
35497-X05	Solid Mid Panel, 8 (200), Each	16 (7.3)
35497-X08	Solid Mid Panel, 10 (250), Each	16 (7.3)
35497-X11	Solid Mid Panel, 12 (300), Each	16 (7.3)
35497-X14	Solid Mid Panel, 15 (380), Each	16 (7.3)
35497-X52	Solid Mid Panel, 6 (150), Pack of 4	62 (28.1)
35497-X55	Solid Mid Panel, 8 (200), Pack of 4	62 (28.1)
35497-X58	Solid Mid Panel, 10 (250), Pack of 4	62 (28.1)
35497-X61	Solid Mid Panel, 12 (300), Pack of 4	62 (28.1)
35497-X64	Solid Mid Panel, 15 (380) Pack of 4	62 (28.1)
35502-X02	Solid Side Panel, Each	19 (8.6)
35502-X52	Solid Side Panel, Pair	35 (15.9)

X=Color, 7=Black, E=Glacier White. Accessories are also available in both 6' (1.8) and 8' (2.4) heights.

PATENTED

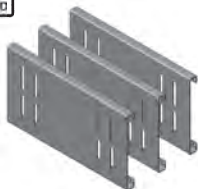

35492-X02

PATENTED

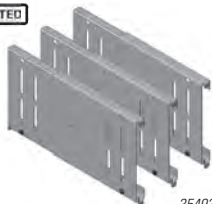

35493-X02



15008-001



35505-001



35506-701

Evolution Cable Management Accessories

Fixed Accessory Panel Kit for Evolution Single-Sided Manager

Kit includes three Fixed Accessory Panels for the Evolution g1 Single-Sided Vertical Cable Manager. Select to match the width of the cable manager; includes installation hardware.

Movable Mid-Section Kit for Evolution Double-Sided Manager

Kit includes three Movable Mid-Sections for the Evolution g2 Double-Sided Vertical Cable Manager. Select to match the width; includes installation hardware.

Cable Distribution Spools

Attaches inside vertical cable managers. Spools are 2.75" (69.9 mm) in diameter and 5.9" L (150 mm) and made from black plastic; each kit includes four spools and mounting hardware. Three large cable distribution spools are included with each 10", 12" and 15" wide (250 mm, 300 mm and 380 mm) vertical cable manager (will not fit other sizes).

Cable Distribution Spool Spacer Kit

Spool Spacer Kit is used to offset the spool, so the front edge of the spool is close to the front edge of cable management fingers in the Evolution g2 Double-Sided Cable Managers. Use in 10", 12" and 15"W (250 mm, 300 mm and 380 mm) managers; includes three spools and three spacers. Attaches to the Movable Mid-Sections. Spacers are 2.8" (71 mm) in diameter, 2.5"H (64 mm) and made from black plastic; each kit includes eight spacers and mounting hardware.

Floor Bracket

Floor Bracket secures the base of the Evolution Vertical Managers to the floor when located at the end of a row of equipment racks. Light-duty, steel bracket with attachment hole sized for 1/4" hardware; packs of 12, order separately.

Part Number	Description Width - in (mm)	Shipping Weight lb (kg)
Fixed Accessory Panel Kit		
35492-X01	For 6 (150) Evolution Single-Sided	3 (1.4)
35492-X02	For 8 (200) Evolution Single-Sided	4 (1.8)
35492-X03	For 10 (250) Evolution Single-Sided	5 (2.3)
35492-X04	For 12 (300) Evolution Single-Sided	6 (2.7)
35492-X05	For 15 (380) Evolution Single-Sided	7 (3.2)
Movable Mid Section Kit		
35493-X01	For 6 (150) Evolution Double-Sided	4 (1.8)
35493-X02	For 8 (200) Evolution Double-Sided	5 (2.3)
35493-X03	For 10 (250) Evolution Double-Sided	5 (2.3)
35493-X04	For 12 (300) Evolution Double-Sided	7 (3.2)
35493-X05	For 15 (380) Evolution Double-Sided	8 (3.6)
15008-001	Cable Distribution Spools, Pack of 4, Black	2 (0.9)
35505-001	Cable Distribution Spool Spacer Kit, Black	1 (0.5)
35506-701	Floor Bracket, Black	3 (1.4)

X=color; 7=Black, E=Glacier White.

Evolution Horizontal Cable Manager

Evolution Horizontal Cable Managers complements the styling of the Evolution Vertical Cable Manager and provides a dedicated horizontal pathway to organize and store cables above patch panels and network switches.

Evolution Horizontal Cable Manager includes plastic T-shaped cable guides to organize patch cords and jumper cords as the cords enter and exit the manager to make individual equipment connections. Two chassis styles are available. Choose the solid chassis option for use in areas where thermal isolation is needed. Use the chassis with pass-through cable ports to allow patch cords to pass front-to-rear.

- Available in four heights; 1U, 2U, 3U, 4U
- Contoured, snap-on front door opens up or down and complements the styling of Evolution Vertical Cable Manager
- 2 chassis styles; solid or with cable pass-through ports
- Plastic T-shaped cable guides organize cables as they enter and exit the manager



35442-X03



35441-X03

Part Number	Chassis Style	Description H x W x D in (mm)	Shipping Weight lb (kg)
35441-X01	Solid	1U x 19 x 8.2 (208)	4 (1.8)
35442-X02	Solid	2U x 19 x 8.2 (208)	5 (2.3)
35442-X03	Solid	3U x 19 x 8.2 (208)	6 (2.7)
35442-X04	Solid	4U x 19 x 8.2 (208)	7 (3.2)
35441-702	With cable pass-through ports	2U x 19 x 8.2 (208)	4 (1.8)
35441-703	With cable pass-through ports	3U x 19 x 8.2 (208)	5 (2.4)
35441-704	With cable pass-through ports	4U x 19 x 8.2 (208)	7 (3.2)

X=Color; 7=Black and E=Glacier White. *1U Horizontal managers available with solid chassis only.

PATENTED

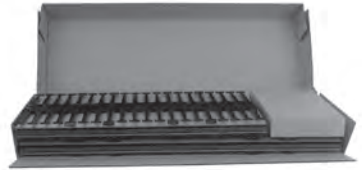

Velocity Cable Managers are easy to ship and store. Compact packaging requires less storage space, reduces waste and is easier and more cost-efficient to ship.

Velocity® Cable Management

CPI's Velocity Cable Management is an economical cable management solution for everyday use in telecommunication rooms, equipment rooms and lab spaces, and creates a complete vertical and horizontal pathway for premise cabling and patch cords on CPI Rack Systems.

Vertical Cable Managers:

Velocity Cable Management includes single- and double-sided vertical cable managers available in four widths and three heights. They can ship unassembled in compact packaging to reduce shipping costs and storage space, providing easier staging and handling on the job site with less packaging to remove. No tools are required to assemble the cable manager. The components simply snap together, and the manager bolts to the side of the rack with included hardware.

The vertical cable manager features a large cross section to maximize internal cable management space. To simplify cable management, T-shaped cable guides and openings on the sides of the manager align with each rack-mount unit and have rounded edges to protect cables from snags. Snap-on covers are included and swing open to the right or left to provide easy access, and protect cables when closed. The manager has openings in the body, which allow cables to easily pass from front-to-rear. Add the accessory Cable Spool Kit to manage fiber, the Cable Lashing Bar Kit to secure large cable bundles or the Cable Ring Kit to create a rear pathway on the back of single-sided managers.

Features:

- Vertical managers for open two-post and four-post CPI Rack Systems that have 3"D (80 mm) mounting channels; do not use with 6" Deep Standard Rack or SeismicFrame Two-Post Rack
- Packaging:
 - Each vertical cable manager ships unassembled in a single carton
 - Each horizontal cable manager ships fully assembled in a single carton
- Material:
 - Vertical cable manager has steel mid panels, splice plates and plastic sides; covers on 3.6"W (91 mm) and 6"W (152 mm) managers are plastic; covers on 10"W (254 mm) and 12"W (305 mm) managers are steel with plastic hinges
 - Horizontal cable manager is plastic
- Finish: Black epoxy-polyester hybrid powder coat paint on steel parts; black plastic

Tool-less, click together assembly:

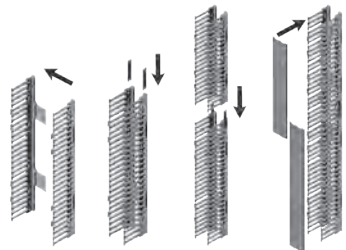

PATENTED



Note: 3.6"W & 6"W ship with extruded plastic doors; 10"W & 12"W ship with metal doors.

Velocity Single-Sided Vertical Cable Managers are 9.5"D (241 mm) without doors. The overall depth listed in the order table varies due to the bevel on the door, which differs slightly with width. Usable depth is 7.5" (191 mm). Usable width is 1.3" (33 mm) less than overall width.

Velocity Single-Sided Vertical Cable Managers

(4) vertical side sections with T-shaped cable guides spaced 1U apart; (4) mid panels with attachment points for cable management accessories; (2) splice plates used to assemble the top and bottom side sections; (2) half-height covers that snap onto the T-shaped cable guides; (8) M8 hex bolts, washers and hex flange nuts to secure cable managers to the rack

Part Number	Height ft (m)	Description H x W x D in (mm)	Shipping Weight lb (kg)
13901-701	6'H (1.8 m) 38U Racks	70 x 3.6 x 9.7 (1778 x 91 x 246)	17 (7.7)
13902-701		70 x 6 x 9.8 (1778 x 152 x 249)	18 (8.2)
13904-701		70 x 10 x 10.3 (1778 x 254 x 262)	30 (13.6)
13905-701		70 x 12 x 10.4 (1778 x 305 x 264)	32 (14.5)
13901-703	7'H (2.1 m) 45U Racks	80.5 x 3.6 x 9.7 (2045 x 91 x 246)	18 (8.2)
13902-703		80.5 x 6 x 9.8 (2045 x 152 x 249)	20 (9.1)
13904-703		80.5 x 10 x 10.3 (2045 x 254 x 262)	32 (14.5)
13905-703		80.5 x 12 x 10.4 (2045 x 305 x 264)	34 (15.4)
13901-715	8'H (2.4 m) 51/52U Racks	91 x 3.6 x 9.7 (2311 x 91 x 246)	19 (8.6)
13902-715		91 x 6 x 9.8 (2311 x 152 x 249)	21 (9.5)
13904-715		91 x 10 x 10.3 (2311 x 254 x 262)	34 (15.4)
13905-715		91 x 12 x 10.4 (2311 x 305 x 264)	36 (16.3)

Color is black.

PATENTED



Note: 3.6"W & 6"W ship with extruded plastic doors; 10"W & 12"W ship with metal doors.

Velocity Double-Sided Vertical Cable Managers are 16"D (406 mm) without doors. The overall depth listed in the order table varies due to the bevel on the door, which differs slightly with width. Usable depth in the front of the manager is 7.5" (191 mm). Usable depth at the rear of the manager is 5.5" (140 mm). Usable width is 1.3" (33 mm) less than overall width.

Velocity Double-Sided Vertical Cable Manager

(4) vertical side sections with T-shaped cable guides spaced 1U apart; (4) mid panels with attachment points for cable management Accessories; (2) splice plates used to assemble the top and bottom side sections; (4) half-height covers that snap onto the T-shaped cable guides; (8) M8 hex bolts, washers and hex flange nuts to secure cable managers to the rack

Part Number	Height ft (m)	Description H x W x D in (mm)	Shipping Weight lb (kg)
13911-701	6'H (1.8 m) 38U Racks	70 x 3.6 x 16.4 (1778 x 91 x 417)	23 (10.4)
13912-701		70 x 6 x 16.6 (1778 x 152 x 422)	26 (11.8)
13914-701		70 x 10 x 17.5 (1778 x 254 x 445)	37 (16.8)
13915-701		70 x 12 x 17.8 (1778 x 305 x 446)	40 (18.1)
13911-703	7'H (2.1 m) 45U Racks	80.5 x 3.6 x 16.4 (2045 x 91 x 417)	25 (11.3)
13912-703		80.5 x 6 x 16.6 (2045 x 152 x 422)	28 (12.7)
13914-703		80.5 x 10 x 17.5 (2045 x 254 x 445)	40 (18.1)
13915-703		80.5 x 12 x 17.8 (2045 x 305 x 446)	43 (19.5)
13911-715	8'H (2.4 m) 51/52U Racks	91 x 3.6 x 16.4 (2311 x 91 x 417)	27 (12.2)
13912-715		91 x 6 x 16.6 (2311 x 152 x 422)	30 (13.6)
13914-715		91 x 10 x 17.5 (2311 x 254 x 445)	44 (20.0)
13915-715		91 x 12 x 17.8 (2311 x 305 x 464)	47 (21.3)

Color is black.



Velocity Cable Management Accessories

Cable Ring Kit- Attaches to the sides with included hardware. Rings are C-shaped, 3.0”H x 7.7”D (76 mm x 196 mm), made from aluminum and painted black; latch is black plastic and spins open to provide access to cables. Cable opening on 3.6”W (91 mm) rings is 1.4”W (36 mm); cable opening on other rings is 3.8”W (97 mm). Each kit includes multiple rings and mounting hardware. The kit for 6’ (1.8 m) includes six rings, the kit for 7’ (2.1 m) includes seven rings, and the kit for the 8’ (2.4 m) includes eight rings.

Cable Spool Kit- Attaches to the mid panel with included hardware. Use in 6”W (152 mm) or wider vertical cable managers; one kit per side. Spools are 2” (51 mm) in diameter and 6”L (152 mm) . Each kit includes four spools and mounting hardware.

Cable Lashing Bar Kit- Attaches to the mid panel with included hardware. Use in 6”W (152 mm) or wider vertical cable managers; one kit per side. Bars are .23” (5.7 mm) in diameter; two bars are 23.7”L (602 mm), four bars are 16.6”L (422 mm).. Each kit includes six lashing bars and mounting hardware.

Part Number	Description Width - in (mm)	Shipping Weight lb (kg)
Cable Ring Kit		
13934-716	Cable Ring Kit for 6 (1.8) x 3.6 (91) Manager, Black	8 (3.6)
13934-717	Cable Ring Kit for 7 (2.1) x 3.6 (91) Manager, Black	9 (4.1)
13934-718	Cable Ring Kit for 8 (2.4) x 3.6 (91) Manager, Black	11 (5.0)
13934-726	Cable Ring Kit for 6 (1.8) x 6 (152) Manager, Black	9 (4.1)
13934-727	Cable Ring Kit for 7 (2.1) x 6 (152) Manager, Black	11 (5.0)
13934-728	Cable Ring Kit for 8 (2.4) x 6 (152) Manager, Black	12 (5.4)
13934-746	Cable Ring Kit for 6 (1.8) x 10 (254) Manager, Black	12 (5.4)
13934-747	Cable Ring Kit for 7 (2.1) x 10 (254) Manager, Black	14 (6.4)
13934-748	Cable Ring Kit for 8 (2.4) x 10 (254) Manager, Black	15 (6.8)
13934-756	Cable Ring Kit for 6 (1.8) x 12 (305) Manager, Black	14 (6.4)
13934-757	Cable Ring Kit for 7 (2.1) x 12 (305) Manager, Black	16 (7.3)
13934-758	Cable Ring Kit for 8 (2.4) x 12 (305) Manager, Black	18 (8.2)
Cable Spool Kit		
13935-701	Cable Spool Kit, Pack of 4, Black	2 (0.9)
Cable Lashing Bar Kit		
13928-001	Cable Lashing Bar Kit, Zinc	2 (0.9)

Velocity Horizontal Cable Manager

Features T-shaped cable guides at the top and bottom of the manager, two cable openings in the rear of the manager allow front-to-rear cabling, and the snap-on cover stays in the opened position to provide easy access to cables.

- (1) 19”W EIA rack-mount cable manager with T-shaped cable guides; (1) cover that snaps-on to the T-shaped cable guides; (4) #12-24 x 1” rack-mount screws and (4) M6 x 25 mm rack-mount screws

Part Number	Description H x W x D in (mm)	Shipping Weight lb (kg)
13930-701	1U x 19 x 5.9 (150), Black	2 (0.9)
13930-702	2U x 19 x 5.9 (150), Black	3 (1.4)

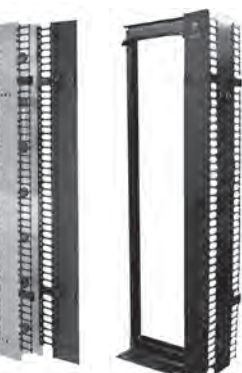

Double-Sided MCS shown with door open

Shown on rack with Jumper Tray

MCS Master Cabling Section

The MCS Master Cabling Section virtually eliminates the need for horizontal cable managers by providing frequent 1U spacing of the cable guides that aligns precisely with the rack spacing.

Includes innovative, rigid aluminum SwitchGate Door/Cover that hides and conceals cable. A handle is included on the outside of the door/cover, making removal and installation even easier.

- Extra-wide, contoured cable guides provide smooth movement and meet UL 94V-0 Flame Resistant standards
- SwitchGate Door/Cover is easily switched from right to left opening and can be removed
- Double-Sided MCS Master Cabling Sections have edge-protected pass-through ports and vertical slots for optional cable ties
- 10"W (250 mm) version includes (4) Cable Distribution Spools
- Mounting hardware and doors are included
- Attaches to Standard Racks, Universal Racks or QuadraRacks

MCS-EFX Master Cabling Section with Extended Fingers

The MCS-EFX is a larger, higher capacity version of the MCS Master Cabling Section and is designed for use with most two- and four-post racks to manage cable at the cross connect, especially when using angled-face copper patch panels. MCS-EFX is packaged in a single carton for easy handling and includes installation hardware.

- Cable openings on the side of MCS-EFX are sized to accommodate 48 patch cords, twice the capacity of the standard MCS; openings have rounded edges to protect cable and will not deform or break
- Patented cable openings on the sides of MCS-EFX align with rack-mount unit space on the rack, allowing cables to exit by rack-mount unit
- The door hinges open to the right or left for easy access to cables during moves, adds and changes and locks in the closed position to protect cables from damage
- Plastic Cable Guides meet UL 94V-0 Flame Resistant standards
- 10"W and 12"W (250 mm and 300 mm) Double-Sided MCS-EFX include (4) Cable Distribution Spools
- Mounting hardware and doors are included
- Attach to Standard Racks, Universal Racks, QuadraRacks or Adjustable QuadraRack frames

PATENTED

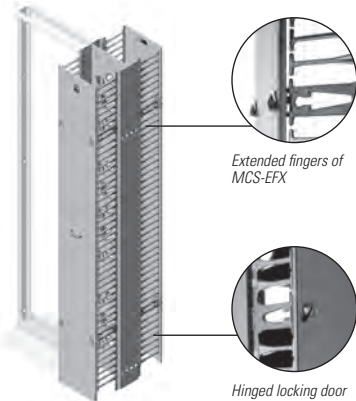

Extended fingers of MCS-EFX

Hinged locking door

Use the part number matrix below to select your MCS Master Cabling Section. **Example Part Number: 30091-703.**

Finger Length		Width/Style		-	Color	Height	
30	Standard	091	4.4"W, Single-Sided*	5	Clear	00	5.6'
40	Extended (EFX)	092	6"W, Single-Sided	7	Black	01	6.0'
		093	10"W, Single-Sided	E	Glacier White	02	6.6'
		094	4.4"W, Double-Sided (3009X)			03	7.0'
		094	12"W Single Sided (4009X)			05	7.6'
		095	6"W, Double-Sided			15	8.0'
		096	10"W, Double-Sided			08	9.0'
		097	12"W, Double-Sided**				

X=Color; 5=Clear, 7=Black, E=Glacier White. Clear (-5XX) versions have black doors/covers and cable guides.

Extended Finger Cabling Sections (EFX) are only available in 7"H, 7.6"H and 8"H.

*[091] option is not valid for (4009X-XXX). **12"W is only available in Extended Finger styles (40097).

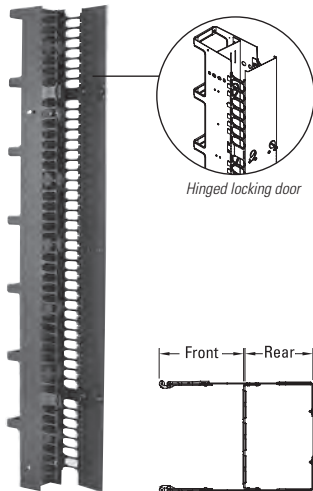

CCS Combination Cabling Section

The CCS Combination Cabling Section offers the best of CPI's cabling sections, but with added design features. This cabling section is double-sided with the front side, featuring plastic cable guides (like those used on the MCS Master Cabling Section,) while the back retains the classic VCS Vertical Cabling Section design.

- 1U cable guides on the front designed for fanning and managing patch cords
- Open cabling section on the rear provides easy access and routes cable bundles feeding into the back of patch panels
- Edge-protected pass-through ports make it easy to route cable from front-to-back; vertical slots along the center separator neatly secure cable bundles
- Plastic Cable Guides meet UL 94V-0 Flame Resistant standards
- Innovative SwitchGate Door/Cover (front) is easily opened from the right or left and can be removed so that cable does not have to thread through guides
- Attach to Standard Racks, Universal Racks, QuadraRack or Adjustable QuadraRack frames
- Mounting hardware and doors are included

Usable Depth

For 3"D (80 mm) Rack Version:

Front=5.90" (149.9 mm); Rear=5.35" (135.9 mm)

For 6"D (150 mm) Rack Version:

Front=7.40" (188.0 mm); Rear=6.85" (174.0 mm)

Part Number 3"D (80 mm) Racks	Height ft (m)	Depth in (mm)	Shipping Weight lb (kg)
3.65"W (92.7 mm)			
30161-X01	6 (1.8)	12.24 (311)	25 (11.3)
30161-X03	7 (2.1)	12.24 (311)	29 (13.2)
30161-X05	7.6 (2.3)	12.24 (311)	31 (14.1)
30161-X15	8 (2.4)	12.24 (311)	33 (15.0)
30161-X08	9 (2.7)	12.24 (311)	38 (17.2)
6"W (150 mm)			
30162-X01	6 (1.8)	12.24 (311)	29 (13.2)
30162-X03	7 (2.1)	12.24 (311)	34 (15.4)
30162-X05	7.6 (2.3)	12.24 (311)	37 (16.8)
30162-X15	8 (2.4)	12.24 (311)	39 (17.7)
30162-X08	9 (2.7)	12.24 (311)	44 (20.0)
10"W (250 mm)			
30163-X01	6 (1.8)	12.24 (311)	40 (18.1)
30163-X03	7 (2.1)	12.24 (311)	46 (20.9)
30163-X05	7.6 (2.3)	12.24 (311)	50 (22.7)
30163-X15	8 (2.4)	12.24 (311)	53 (24.0)
30163-X08	9 (2.7)	12.24 (311)	59 (26.8)

Part Number 6"D (150 mm) Racks	Height ft (m)	Depth in (mm)	Shipping Weight lb (kg)
3.65"W (92.7 mm)			
30164-X01	6 (1.8)	14.61 (371)	28 (12.7)
30164-X03	7 (2.1)	14.61 (371)	33 (15.0)
30164-X05	7.6 (2.3)	14.61 (371)	36 (16.3)
30164-X15	8 (2.4)	14.61 (371)	38 (17.2)
30164-X08	9 (2.7)	14.61 (371)	43 (19.5)
6"W (150 mm)			
30165-X01	6 (1.8)	14.61 (371)	33 (15.0)
30165-X03	7 (2.1)	14.61 (371)	38 (17.2)
30165-X05	7.6 (2.3)	14.61 (371)	41 (18.6)
30165-X15	8 (2.4)	14.61 (371)	44 (20.0)
30165-X08	9 (2.7)	14.61 (371)	49 (22.2)
10"W (250 mm)			
30166-X01	6 (1.8)	14.61 (371)	42 (19.1)
30166-X03	7 (2.1)	14.61 (371)	49 (22.2)
30166-X05	7.6 (2.3)	14.61 (371)	53 (24.0)
30166-X15	8 (2.4)	14.61 (371)	56 (25.4)
30166-X08	9 (2.7)	14.61 (371)	63 (28.6)

X=color; 7=Black, E=Glacier White.

CCS-EFX Combination Cabling Section With Extended Fingers

The CCS-EFX is a double-sided vertical cable management trough designed for use with most two- and four-post racks to manage cable at the cross connect, especially when using angled-face copper patch panels.

The CCS-EFX is manufactured from a combination of strong, lightweight aluminum sheet and plenum-rated composite materials for maximum strength at minimal weight. CCS-EFX is packaged in a single carton for easy handling and includes installation hardware.

- Cable openings on the front are sized to fit 48 patch cords, twice the capacity of the CCS; openings have rounded edges to protect cable and will not deform or break
- Cable openings on front of CCS-EFX align with rack-mount unit on rack, allowing cables to exit by rack-mount unit
- The front door hinges open to the right or left and locks in the closed position to protect cables
- Open cabling section on the rear of CCS-EFX allows large premise cable bundles to exit the manager into the rack-mount space. Spin closure latches secure cables
- Attach to 3"D (80 mm) Standard Racks, Universal Racks or QuadraRack frames
- Mounting hardware and doors are included

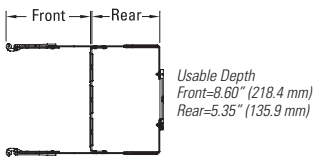
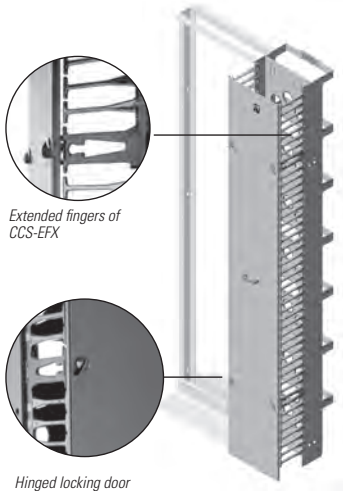

Part Number	Height ft (m)	Description H x W x D in (mm)	Shipping Weight lb (kg)
6"W (150 mm)			
40098-X03	7 (2.1)	14.94 (379.5)	38 (17.2)
40098-X05	7.6 (2.3)	14.94 (379.5)	41 (18.6)
40098-X15	8 (2.4)	14.94 (379.5)	44 (20.0)
10"W (250 mm)			
40099-X03	7 (2.1)	14.94 (379.5)	52 (23.6)
40099-X05	7.6 (2.3)	14.94 (379.5)	56 (25.4)
40099-X15	8 (2.4)	14.94 (379.5)	60 (27.2)
12"W (300 mm)			
40100-X03	7 (2.1)	14.94 (379.5)	56 (25.4)
40100-X05	7.6 (2.3)	14.94 (379.5)	60 (27.2)
40100-X15	8 (2.4)	14.94 (379.5)	64 (29.0)

X=Color, 7=Black, E=Glacier White.

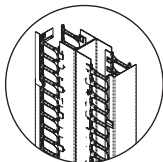

Double-Sided

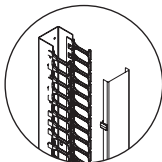

Single-Sided

Global Vertical Cabling Section

An adaptable vertical cable management solution with a unique, two-piece design that reduces shipping size and cost. The two parts can be quickly assembled and then bolted to CPI's Universal and Standard racks, as well as QuadraRack and Adjustable QuadraRack frames. It ships partially assembled with patented cable guide fingers at 1U intervals. Each single-sided section includes a two-piece section, a two-piece door/cover and mounting hardware. Each double-sided section is a one-piece section and two-piece door/cover.

- Patented cable guide fingers at 1U intervals provide an organized pathway for cable and patch cords; 7'H (2.1 m) provides 45U
- Snap-on, hinged door/cover hides cable for a finished appearance, yet allows quick access to cable for making changes
- Door/cover swings on hinges to open left or right
- Acorn nuts eliminate sharp edges, reducing injuries and torn cables
- Seven 2.5" (64 mm) pass-through ports allow cables to transition front to back

Part Number	Description Width in (mm)	Shipping Weight lb (kg)
12830-X03	Single-Sided, 7'H x 3.65"W x 6.76"D, Narrow (2.1 m x 92.7 mm x 171.7 mm)	16 (7.3)
12832-X03	Single-Sided, 7'H x 3.65"W x 9.30"D, Narrow (2.1 m x 92.7 mm x 236.2 mm)	18 (8.2)
12831-X03	Single-Sided, 7'H x 6"W x 6.76"D, Wide (2.1 m x 150 mm x 171.7 mm)	19 (8.6)
12833-X03	Single-Sided, 7'H x 6"W x 9.30"D, Wide (2.1 m x 150 mm x 236.2 mm)	22 (10.0)
12834-X03	Single-Sided, 7'H x 10"W x 6.76"D, Wide (2.1 m x 250 mm x 171.7 mm)	26 (11.8)
12835-X03	Single-Sided, 7'H x 10"W x 9.30"D, Wide (2.1 m x 250 mm x 236.2 mm)	28 (12.7)
14830-X03	Double-Sided, 7'H x 3.65"W x 13.52"D, Narrow (2.1 m x 92.7 mm x 343.4 mm)	32 (14.5)
14831-X03	Double-Sided, 7'H x 6"W x 13.52"D, Wide (2.1 m x 150 mm x 343.4 mm)	39 (17.7)
14832-X03	Double-Sided, 7'H x 10"W x 13.52"D, Wide (2.1 m x 250 mm x 343.4 mm)	47 (21.3)

X-color: 5=Clear, 7=Black, E=Glacier White. Clear (-5XX) versions are only available in Double-Sided versions, and have black doors/covers and cable guides.

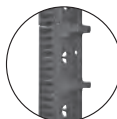
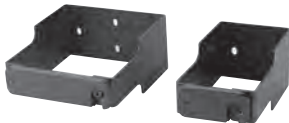

Rings shown attached to GVCS

Cable Rings For GVCS

Part Number & Finish		Description	Shipping Weight lb (kg)
Black	Glacier White		
12836-701	12836-E01	3.65"W (92.7 mm) Rings	4 (1.8)
12836-702	12836-E02	6"W (150 mm) Rings	5 (2.3)
12836-703	12836-E03	10"W (250 mm) Rings	7 (3.2)

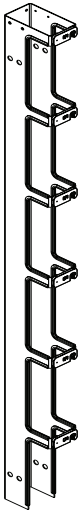

11730-X03
Single-Sided Narrow

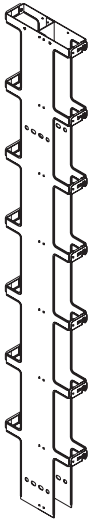

12096-X03
Double-Sided Narrow

Narrow Vertical Cabling Section

- Bolts to CPI Standard Rack, Universal Rack, QuadraRack 4-Post Frame and QuadraRack Server Frame
- Includes formed cabling section, lockable cabling latches - 12" (300 mm) between latches, protective edge guards and mounting hardware

Single-Sided:

- 9' (2.7 m) version consists of a 7' (2.1 m) section and 2' (0.6 m) extension

Double-Sided:

- 1.38" x 2.25" (35.1 mm x 57.2 mm) oval pass-through ports every 11.62" (295.1 mm)
- 9' (2.7 m) version consists of 7' (2.1 m) section with a 2' (0.6 m) extension
- Mounting hardware included

Part Number	Description Width in (mm)
11730-X00	5.6 (1.7 m) H x 3.65"W x 6.38"D (92.7 mm x 162.1 mm), SS
11730-X01	6' (1.8 m) H x 3.65"W x 6.38"D (92.7 mm x 162.1 mm), SS
11730-X02	6.6 (2.0 m) H x 3.65"W x 6.38"D (92.7 mm x 162.1 mm), SS
11730-X03	7' (2.1 m) H x 3.65"W x 6.38"D (92.7 mm x 162.1 mm), SS
11730-X05	7.6' (2.3 m) H x 3.65"W x 6.38"D (92.7 mm x 162.1 mm), SS
11730-X15	8' (2.4 m) H x 3.65"W x 6.38"D (92.7 mm x 162.1 mm), SS
11730-X08	9' (2.7 m) H x 3.65"W x 6.38"D (92.7 mm x 162.1 mm), SS
12096-X03	7' (2.1 m) H x 3.65"W x 12.75"D (92.7 mm x 323.9 mm), DS
12096-X15	8' (2.4 m) H x 3.65"W x 12.75"D (92.7 mm x 323.9 mm), DS
12096-X08	9' (2.7 m) H x 3.65"W x 12.75"D (92.7 mm x 323.9 mm), DS

X=color: 1=Gray, 5=Clear, 7=Black, E=Glacier White.



11734-X03
Single-Sided Wide



12096-X03
Double-Sided Narrow

Wide Vertical Cabling Section

- Bolts to CPI Standard Rack, Universal Rack, QuadraRack 4-Post Frame and QuadraRack Server Frame

Single-Sided:

- 6" W x 6.38" D (150 mm x 162.1 mm); single-sided cable trough
- 9' (2.7 m) version consists of 7' (2.1 m) section with a 2' (0.6 m) extension

Double-Sided:

- 2.5" (64.0 mm) diameter pass-through ports every 11.62" (295.1 mm)
- 9' (2.7 m) version consists of a 7' (2.1 m) section with a 2' (0.6 m) extension
- Mounting hardware included

Part Number	Description Width in (mm)
11374-X00	5.6 (1.7 m) H x 6"W x 6.38"D (150 mm x 162.1 mm)
11374-X01	6' (1.8 m) H x 6"W x 6.38"D (150 mm x 162.1 mm)
11374-X02	6.6 (2.0 m) H x 6"W x 6.38"D (150 mm x 162.1 mm)
11374-X03	7' (2.1 m) H x 6"W x 6.38"D (150 mm x 162.1 mm)
11374-X05	7.6' (2.3 m) H x 6"W x 6.38"D (150 mm x 162.1 mm)
11374-X15	8' (2.4 m) H x 6"W x 6.38"D (150 mm x 162.1 mm)
11374-X08	9' (2.7 m) H x 6"W x 6.38"D (150 mm x 162.1 mm)
11729-X03	7' (2.1 m) H x 6"W x 12.75"D (150 mm x 323.9 mm), DS
11729-X15	8' (2.4 m) H x 6"W x 12.75"D (150 mm x 323.9 mm), DS
11729-X08	9' (2.7 m) H x 6"W x 12.75"D (150 mm x 323.9 mm), DS

X=color: 1=Gray, 5=Clear, 7=Black, E=Glacier White.

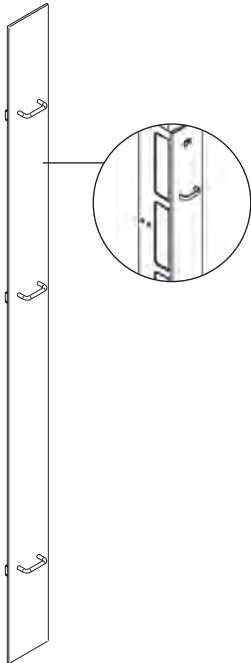

Cabling Section Cover

Designed to be used on narrow and wide Vertical Cabling Sections to provide a clean, professional appearance. Available in metal or plexiglass versions; plexiglass for 7' (2.1 m) only; in sizes to fit your installation.

- Hides cables
- Provides professional appearance
- Quick attachment and removal
- For use with vertical cabling sections only

Part Number	Height ft (m)	Description/Style	Shipping Weight lb (kg)
3.65" W (92.7 mm)			
12664-X02	7 (2.1)	Metal	8 (3.6)
11923-X05	7.6 (2.3)	Metal	4 (1.8)
11923-X15	8 (2.4)	Metal	5 (2.3)
11923-X08	9 (2.7)	Metal	5 (2.3)
6" W (150 mm)			
12664-X01	7 (2.1)	Metal	9 (4.1)
11922-X05	7.6 (2.3)	Metal	7 (3.2)
11922-X15	8 (2.4)	Metal	7 (3.2)
11922-X08	9 (2.7)	Metal	8 (3.6)

X=color: T=Black, E=Glacier White

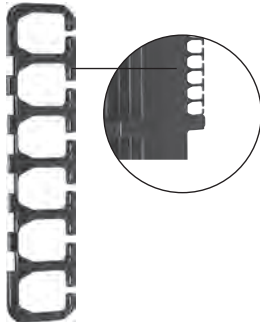

Finger Snaps Cable Guides

Adding Finger Snaps Cable Guides is a snap. The unique design provides retrofit cable guides in-between the latches on VCS Vertical Cabling Sections or CCS Combination Cabling Sections.

- Plastic cable guides that easily retrofit onto CPI VCS Vertical Cabling Sections or CCS Combination Cabling Sections
- Resilient composite material ensures long lasting, quality construction
- Extra-wide and contoured guides allow smooth transition of the cable from the horizontal pathway into a CPI cabling section
- 1U cable guides are designed for fanning and managing patch cords or cables
- Meets UL 94V-0 Flame Resistant standards

Part Number	Description	Shipping Weight lb (kg)
12370-001	2 Finger Snaps, Black	1 (0.5)
12370-002	12 Finger Snaps, Black	2 (0.9)

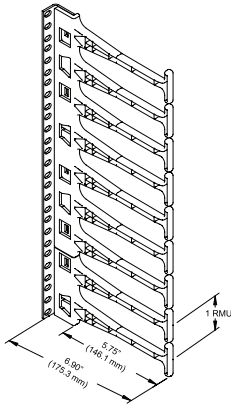

Extended Fingers Bracket

Extended Fingers Bracket provides extra-deep cable management capacity and improves cable bend radius management, meeting or exceeding the needs of the latest Category 5e/6/6a or fiber industry standards. It is a cost-effective accessory for cable management in specific areas of the rack, rather than along its entire height.

- Preassembled in 7U, 9U and 13U heights for mounting directly onto any industry-standard rack
- Patented cable guide fingers at 1U intervals provide an organized cable pathway
- Made of durable, flame-retardant (UL 94V-0) plastic for environmental safety
- Also compatible with accessory cable management finger kits for SeismicFrame Two-Post Rack, Adjustable Rail QuadraRack and Adjustable Rail ServerRack see P/N 13696-00X and 15286-0XX, respectively)

Part Number	Description	Shipping Weight lb (kg)
12891-X03	7U, Each	2 (0.9)
12891-X01	9U, Each	4 (1.8)
12891-X02	13U, Each	4 (1.8)

X=Color: 7=Black, E=Glacier White.

Tool-less Bend Radius Kit for Fiber Patch Cords

Tool-less Bend Radius Kit for Fiber Patch Cords ensures proper bend radius support for fiber optic patch cords when transitioning through T-shaped cable guides. It snaps onto the finger manager without any tools, and can be used for new or retrofit applications. Color is Black.

- Compatible with N-Series TeraFrame® Gen 3 Network Cabinet System, Evolution and Motive Cable Management
- Also compatible with accessory cable management finger kits for SeismicFrame Two-Post Rack, Adjustable Rail QuadraRack and Adjustable Rail ServerRack (see P/N 13696-00X and 15286-0XX, respectively)

Part Number	Description	Shipping Weight lb (kg)
32697-001	Tool-less Bend Radius Kit, Pack of 10	1 (0.5)
32697-002	Tool-less Bend Radius Kit, Pack of 50	3 (1.4)





Spools mounted on a double-sided vertical cabling section

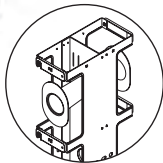

Cable Distribution Spools

ECable Distribution Spools provide slack management and strain relief for patch cords and jumper cables inside CPI Vertical Cable Managers. Designed for use inside any CPI double-sided vertical cable manager 10"W and wider, including VCS, MCS, MCS-EFX, CCS, CCS-EFX and Evolution® g2 Double-Sided Vertical Cable Manager. Also compatible with Evolution® g1 Single-Sided Vertical Cable Manager.

- Three large cable distribution spools are included with each 10", 12" and 15"W (250 mm, 300 mm and 380 mm) vertical cable manager (will not fit other sizes)
- Attaches to the fixed adapter panels on the back of single-sided vertical cable managers and the Movable Mid-Sections inside the double-sided vertical cable managers
- Spools are 2.75" (69.9 mm) in diameter, 5.9"L (150 mm) and made from black plastic
- Each kit includes four spools and mounting hardware
- Made of high-impact, flame retardant material

Part Number	Description	Shipping Weight lb (kg)
15008-001	Spool Kit, Black	2 (0.9)

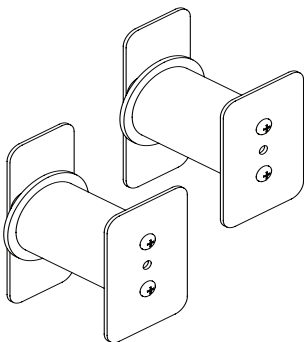

2" (50 mm) Diameter Fiber Management Spools

Use the 2" (50 mm) Diameter Fiber Management Spool to support fiber and copper cables within CPI's extensive line of vertical cabling sections. The spools meet EIA/TIA bend radius requirements, and minimize cable tangles and tears for more efficient data transmission.

- Provides proper cable support and bend radius for more efficient data transmission
- Maintains strength under heavy cable loads
- Mounts to all CPI vertical cabling sections 6"W (150 mm) or wider, including MCS, MCS-EFX, CCS, CCS-EFX and VCS

Part Number	Application Width in (mm)	Package Of	Shipping Weight lb (kg)
3.65"W (92.7 mm)			
12766-X02	For 6, 10 or 12 (150, 250 or 300) Double-Sided Cabling Sections	2	2 (0.9)
12766-X07	For 6, 10 or 12 (150, 250 or 300) Double-Sided Cabling Sections	7	5 (2.3)

X=color: 7=Black, E=Glacier White



Universal Horizontal Cable Manager

Create a highly functional horizontal pathway for patch cords and multimedia applications using coax, copper and fiber optic cables. After routing the cables or cords, simply snap-on the cover for a clean, professional appearance.

- Extra-wide and contoured cable guide fingers, spaced 1.75" (44.5 mm) apart, separate and organize patch cords for quick and easy moves, adds and changes.
- The cable guides are offset to ensure proper bending radii of patch cables, even hooded patch cables
- Patented fingers meet the requirements of UL 94V-0 flammability rating
- Snap-on covers are easy to use and open 180° up or down with adjacent installation
- Covers and panel have a black powder-coat textured finish, reducing fingerprints and smudges

Double-Sided Universal Horizontal Cable Manager

Part Number	Description H x W x D in (mm)	Shipping Weight lb (kg)
30529-X19	1U x 19 x 11.73 (297.9)	5 (2.3)
30529-X23	1U x 23 x 11.73 (297.9)	6 (2.7)
30530-X19	2U x 19 x 11.73 (297.9)	6 (2.7)
30530-X23	2U x 23 x 11.73 (297.9)	7 (3.2)
30531-X19	3U x 19 x 11.73 (297.9)	6 (2.7)
30531-X23	3U x 23 x 11.73 (297.9)	7 (3.2)

X=Color: 7=Black, E=Glacier White.

Single-Sided Universal Horizontal Cable Manager

Part Number	Description H x W x D in (mm)	Shipping Weight lb (kg)
30139-X19	1U x 19 x 4.96 (126.0)	2 (0.9)
30139-X23	1U x 23 x 4.96 (126.0)	3 (1.4)
30130-X19	2U x 19 x 5.14 (130.6)	3 (1.4)
30130-X23	2U x 23 x 5.14 (130.6)	4 (1.8)
30131-X19	3U x 19 x 5.14 (130.6)	4 (1.8)
30131-X23	3U x 23 x 5.14 (130.6)	5 (2.3)
30339-X19*	1U x 19 x 6.26 (159.0)	3 (1.4)
30339-X23*	1U x 23 x 6.26 (159.0)	3 (1.4)
30330-X19*	2U x 19 x 6.44 (163.6)	4 (1.8)
30330-X23*	2U x 23 x 6.44 (163.6)	5 (2.3)
30331-X19*	3U x 19 x 6.44 (163.6)	5 (2.3)
30331-X23*	3U x 23 x 6.44 (163.6)	6 (2.7)

X=Color: 7=Black, E=Glacier White. *Note: Deep Panel is used when Double-Sided MCS Master Cabling Sections are center-mounted on 3"D racks.

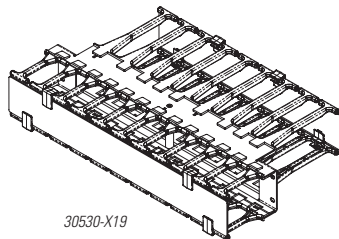

30530-X19

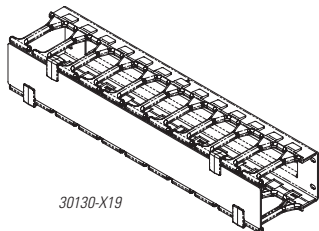

30130-X19

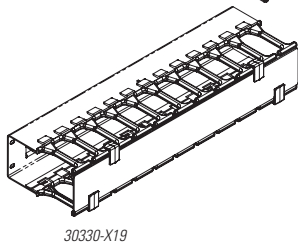

30330-X19

Use Universal Horizontal Cable Manager in conjunction with the CPI Patch Panel Wire Management Bar (P/N 12176-X01) and any of CPI's vertical cabling sections for clean, organized cable management.

Horizontal Cable Management Accessories

Patch Panel Wire Management Bar

19" rack-mountable bar provides the necessary wire management and strain relief recommended by ANSI/TIA/EIA. May be mounted inward for 6" (150 mm) channel or outward to standard 3" (80 mm) rack side channel; attaches to rack with standard #12-24 rack screws (not included). Wire tie holes maintain wire perpendicular relative to termination point; made of sturdy aluminum and sold individually.

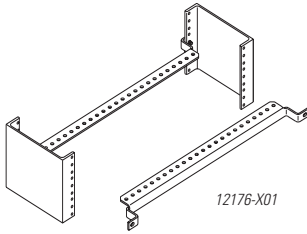

Horizontal Wire Management Panel for VCS

19" Wire Management Panel is offset 1.5" (38 mm) from the rack channel to ensure proper bending radii of patch cables, even hooded patch cables. Use in combination with VCS Vertical Cabling Sections. Unique offset design provides patch cable pathway from front-to-back or side-to-side. Available in single 1.75" (44.5 mm) or double 3.5" (89.0 mm) rack-mount unit designs. Mounts quickly and easily using threaded cable distribution spools; cable distribution spools maintain bend radius through the pass-through trough and across the front plane of the horizontal manager.

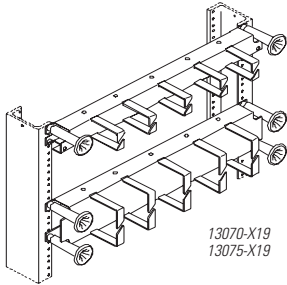

Horizontal Wire Management Panel for MCS and CCS

Use in combination with MCS Master Cabling Section and CCS Combination Cabling Section to provide open horizontal management for cables.

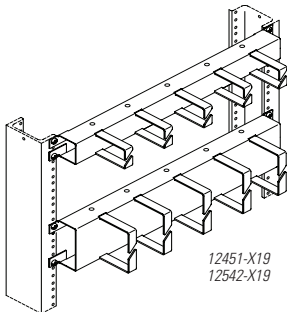

Part Number	Description Width - in (mm)	Shipping Weight lb (kg)
12176-X01	Patch Panel Wire Management Bar	1 (0.5)
13070-X19	Horizontal Wire Panel for VCS, 1U	2 (0.9)
13075-X19	Horizontal Wire Panel for VCS, 2U	2 (0.9)
12541-X19	Horizontal Wire Panel for MCS/CCS, 1U	2 (0.9)
12542-X19	Horizontal Wire Panel for MCS/CCS, 2U	2 (0.9)

X=color: 1=Gray, 5=Clear, 7=Black, E=Glacier White.

2U

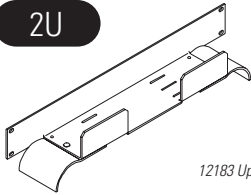

12183 Upper Tray

2U

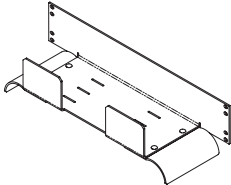

13183 Deep Upper Tray

2U

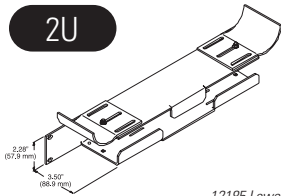

12185 Lower Tray, Single

3U

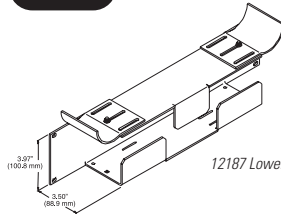

12187 Lower Tray, Double

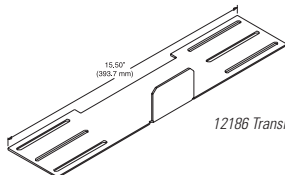

12186 Transition Plate

Jumper and Transition Trays

The Jumper and Transition Trays aid in compliance with ANSI/TIA/EIA-568B bend radius requirements. Two styles are available to provide upper and lower horizontal/vertical cable management and promote a gradual, controlled bend for both UTP and optical fiber cable. Adjust the position of the bend radius to deliver cables into the vertical cable manager or attach a transition plate between trays to create a solid wire way between racks. Mounting screws not included. Sold individually.

- Provides 1-1/2" (38 mm) bend radius for compliant installation of Category 5e/6/6a or fiber cable
- Telescopes to adjust cable entry or exit position
- Mounts on 19" or 23" rack; may also be wall-mounted
- Strong lightweight aluminum construction

Part Number		Description	Shipping Weight lb (kg)
19"	23"		
12183-X19	12183-X23	Upper Tray, 3.5"D (89 mm)	3 (1.4)
13183-X19	13183-X23	Upper Tray, 6"D (150 mm)	4 (1.8)
12185-X19	12185-X23	Lower Tray, Single, 3.5"D (89 mm)	4 (1.8)
12187-X19	12187-X23	Lower Tray, Double, 3.5"D (89 mm)	5 (2.3)
12186-X01	N/A	Transition Plate, 15.5"L (394 mm)	2 (0.9)

X=color: 1=Gray, 5=Clear, 7=Black, E=Glacier White.

2U

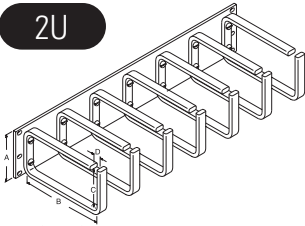

A 3.47" (88.1 mm)
 B 6.00" (152.4 mm)
 C 2.85" (72.4 mm)
 D 0.56" (14.2 mm)

Large Horizontal Ring Panel

Used to organize horizontal cable runs. Large 2.8"H (71 mm) by 6"W (150 mm) heavy duty aluminum rings with rounded edges protect cable sheaths and will not bind during installation. Rings are bolted onto panels, so they can be added or removed as needed. 19" and 23" wide rack panel options come pre-assembled with seven equally spaced rings.

- 2.8"H x 6"W (71 mm x 150 mm) heavy duty aluminum rings
- Rings can be added or removed as needed
- Installation hardware not included
- Shipping weight approximately 5 lb (2.3 kg)

Part Number		Description
19"	23"	
11564-X19	11564-X23	Ring Panel

X= color: 1=Gray, 5=Clear, 7=Black, E=Glacier White.

1U

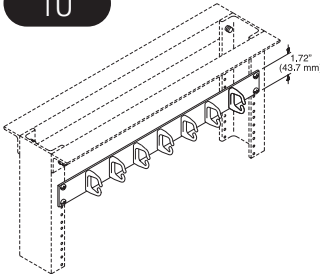

Rack Cabling Managers

Used to organize horizontal cable and wire runs. Two sizes of slotted plastic rings provide ample room to hold all types and sizes of wiring and cabling.

- Easy to install on equipment racks
- Installation hardware not included

Part Number	Description Width - in (mm)
11752-X19	19"W Rack, 1U, 1.6 x 1.3 (41 x 33) Rings
11752-X23	23"W Rack, 1U, 1.6 x 1.3 (41 x 33) Rings
11753-X19	19"W Rack, 2U, 3 x 1.6 (80 x 41) Rings
11753-X23	23"W Rack, 2U, 3 x 1.6 (80 x 41) Rings

X= color: 1=Gray, 5=Clear, 7=Black, E=Glacier White.

2U

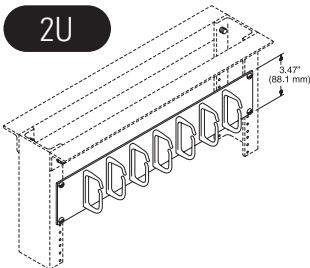

Slip-On Cover, Ring Panel

The Slip-On Cover is used on the Large Horizontal Ring Panel, P/N 11564-XXX. Sold individually.

Part Number	Description Width - in (mm)	Shipping Weight lb (kg)
11764-X19	Slip-On Cover, 19"W,	2 (0.9)

X= color: 1=Gray, 7=Black, E=Glacier White
 Also available in 23" W (-X23) and 25" (-X25).

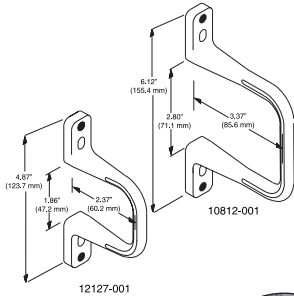

Closed Composite Distribution Rings

With Distribution Rings, all your wiring and cabling can now be neatly and easily organized and managed. Designed to support cable and wire in communication closets, on backboards, equipment racks or wherever cable runs are required. The versatile brackets are made of high-strength, fire-retardant composite material. Rounded edges prevent damage to cable and wire insulation, while providing easy pull-through. Mounting hole configuration allows brackets to be attached to most surfaces, including CPI equipment racks. Color is compatible with most equipment. Mounting hardware not included.

- Strong, lightweight, fire-retardant composite material construction
- Easy to install onto CPI equipment racks or backboards
- Rounded shape eliminates cable nicks, great for wire pulling

Part Number		Description	Shipping Weight lb (kg)
Each	Box of 100		
12127-001	12127-011	2 (50) Closed "D" Ring	6 (2.7)
10812-001	10812-011	3 (80) Closed "D" Ring	9 (4.1)

Color is gray. Shipping Weights are for Box of 100.

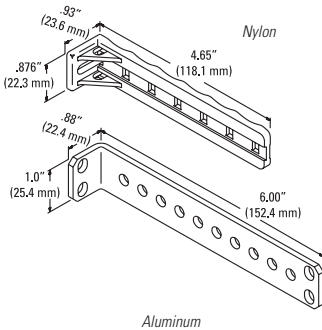

Stand-Off Tie Bracket

These brackets mount to the back of the rack channel to provide a convenient point to tie-down cable runs.

- Choice of either non-conductive nylon or high-strength aluminum
- Either end of the aluminum bracket can be attached to rack, allowing cabling to run several different ways
- Mounting hardware not included

Part Number		Description	Shipping Weight lb (kg)
Each	Box of 50		
10001-001	10001-050	1 x 5 (30 x 130), White Nylon	3 (1.4)
10559-X00	10559-X50	1 x 6 (30 x 150), Aluminum	5 (2.3)

X=color: 1=Gray, 5=Clear, 7=Black, E=Glacier White. Shipping Weights are for Box of 50.

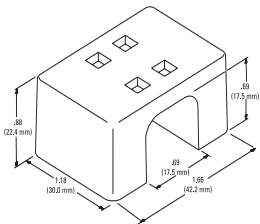

Mag-Clips, Medium Sized

The medium-sized 17000 and 17100 magnetic clips are designed to hold a 25-pair cable or several electrical cords. Keeps cables within workstation areas neat and off of the floor to reduce the chance of accidents. Nylon cable ties can be laced through the four square holes in the top of the 17000 series to secure additional cables.

Part Number		Description	Shipping Weight lb (kg)
Each	Box of 50		
17000-000	17000-050	Clip With Holes	7 (3.2)
17100-000	17100-050	Clip Without Holes	7 (3.2)

Color is Gray. Shipping Weights are for Box of 50.

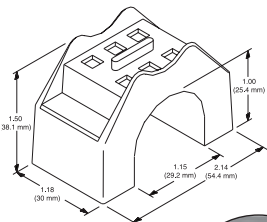

Mag-Clips, Large

This larger clip holds a 100-pair telephone cable or up to 1" (30 mm) diameter tubing. There are also holes provided to lace additional cords to the top of the clip. The amount of direct pull required to separate the clips from a painted steel surface averages 15 lb (67 kg).

Part Number		Description	Shipping Weight lb (kg)
Each	Box of 25		
17500-000	17500-020	Clip	7 (3.2)

Color is Gray. Shipping Weights are for Box of 25.

SECTION 3

POWER MONITORING & SECURITY

eConnect® Power Distribution Units (PDU)	3-3
Basic eConnect PDU	3-6
Metered eConnect PDU	3-10
Monitored eConnect PDU	3-12
Monitored Pro eConnect PDU	3-16
Switched eConnect PDU	3-21
Switched Pro eConnect PDU	3-24
eConnect PDU Accessories	3-29
Power IQ® for eConnect PDUs	3-30
Power Strips	3-31
Remote Infrastructure Management (RIM)	3-39
Electronic Lock Kits	3-46
Uninterruptible Power Supplies (UPS)	3-48
UPS Accessories	3-64
Extended Warranty & Services	3-66



Learn about CPI's Standard Limited Warranty and Extended Limited Warranties. See page vii for details.

POWER MONITORING & SECURITY

CPI's Environmental Monitoring and Security Systems provide a variety of products to meet the need for security and monitoring within the data center.

Where Can I Learn More?

To learn more about CPI's Power Monitoring & Security Products, or to find additional part numbers not listed in this catalog, please visit our website, chatsworth.com.

Related Tools:

Use these tools, under the Resources tab on chatsworth.com, to simplify your planning, selection, order and purchase of CPI Power Monitoring & Security Products.

- BIM Drawings
- CPI Power Selector
- eConnect® Secure Array® Savings Estimator
- eConnect Online Demo
- eConnect PDU Software Demo
- Power IQ Demo

Featured Product:

eConnect® Power Distribution Units (PDU)

eConnect® PDUs provide the ultimate solution for cabinet-level power management, environmental monitoring and electronic access control in multi-tenant and enterprise data centers.

CPI's Intelligent eConnect® Vertical PDUs

Available in over 350 standard configurations—provide users with a variety of high-performance features and benefits that can help solve application needs from big to small, low to high density and in traditional or nontraditional environments.

No other PDU offers the broad application versatility of CPI's eConnect PDU. Designed to simplify deployment, installation and service, eConnect PDUs have helped to power and protect ICT equipment in countless applications and sites thanks to CPI's industry wide high performance and reliability.

Use Vertical eConnect PDUs in data centers and equipment rooms with 42U or higher racks, cabinets and enclosures to provide power connections alongside equipment for higher-density applications. Use Redundancy Pack to support redundant power circuits.



Hydraulic-Magnetic Breakers



Color-coded Labels Printed on Metal



Status LED Light



Field-Replaceable Controller Module

Note: Basic Vertical eConnect PDUs do not have Field-Replaceable Modules



Locking Outlets



- 1 Proprietary Auxiliary Ports for Lock Kits
- 2 Serial Console port - USB Mini Type B
- 3 Status LED
- 4 Ethernet port - RJ45
- 5 Serial Console port - RJ45
- 6 USB Type A ports for Firmware and Temperature/ Humidity Sensors
- 7 Secure Array Ports - RJ45 - for linking of up to 48 PDUs
- 8 LCD Local Display

CPI's Intelligent eConnect Horizontal PDUs

Use Horizontal eConnect PDUs in applications that require outlets at the top or bottom of cabinets for quick access, low- to medium-density applications that require fewer connections and in distributed infrastructure for edge applications. Horizontal PDUs are available in 1U and 2U heights with up to 24 outlets.

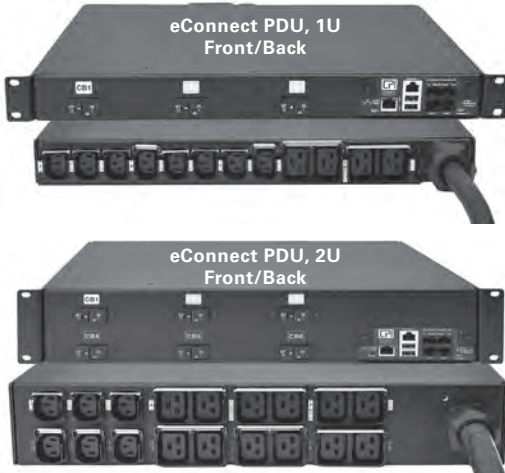

Note: Basic Horizontal eConnect PDUs do not have Field-Replaceable Modules



Preinstalled Adjustable Depth Mounting Brackets



Hydraulic-Magnetic Breakers



Field-Replaceable Controller Module



Locking Outlets

Field-Replaceable Controller Module

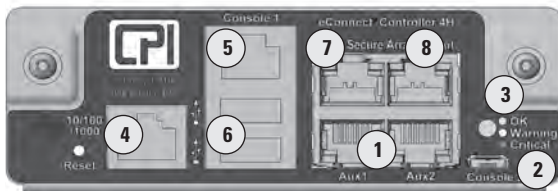

Note: Horizontal eConnect PDUs do not have a LCD Local Display.

- 1 Proprietary Auxiliary Ports
- 2 Console 2 Port - USB
- 3 Status LED
- 4 Ethernet Port - RJ45
- 5 Console 1 Port - RJ45
- 6 USB Type A Ports for Firmware and Temperature/Humidity Sensors
- 7 Secure Array/PDU Linking/Serial Port (link-in)
- 8 Secure Array/PDU Linking/Serial Port (link-out)

eConnect PDU Selection Guide

The first step when selecting a rack PDU is to identify the level of functionality. The chart below summarizes the monitoring and control differences.

eConnect Model	Basic Power Distribution	Inlet Metering	Branch Circuit Metering	Remote Access	Access Control	Outlet Metering	Switched Outlets
Basic	✓						
Metered	✓	✓					
Monitored	✓	✓	✓	✓	✓		
Monitored Pro	✓	✓	✓	✓	✓	✓	
Switched	✓	✓	✓	✓	✓		✓
Switched Pro	✓	✓	✓	✓	✓	✓	✓



The Power Selector enables you to select the best power product for your application by narrowing down options based on your requirements. After you're done comparing, you can email or print the results. Visit selectapdu.com to access the Power Selector.



Vertical and Horizontal Options Available



Basic eConnect PDUs provide reliable power distribution in high-density applications where no power monitoring is required.

Resistance to High Temperature

Market-leading temperature ratings of up to 149°F (65°C) ensures reliability when mounted toward hot aisles

Simplified Load Balancing

Phase-balance outlets on three-phase models ensure equal loading across all phases; allows use of shorter equipment power cords for better cable and airflow management

No Accidental Disconnections

Patented, low-profile locking outlets prevent accidental disconnections without requiring special cords

Easy Identification of Failover Unit

Redundancy Pack includes 2 PDUs (one in Black and one in Glacier White) for easy identification of the primary and secondary unit

Latest UL Compliance

Meets UL and IEC 62368 for compliance with new listing requirements for North America and the European Union

Cabinet Preinstallation

Complete ecosystem ships ready for IT equipment integration. Saves deployment time and reduces packaging waste.

Basic eConnect PDU

Additional Features:

- Breaker and outlet groups are color-coded in multi-breaker units for easy identification
- Universal tool-less mounting features
- Customization capabilities: outlet configurations, color options, power cord length, input connection types and more
- Made in the United States, TAA-compliant

Specifications:

- Single-input, vertical and horizontal rack-mount PDUs
- Circuit Protection:
 - UL 489 listed, single- or two-pole, hydraulic-magnetic breakers available on single- and three-phase models with 30A and above input
 - 10kAIC breakers on 220-240/380-415 VAC models; 5kAIC for all other models
 - Low-profile design prevents accidental discharge
- Power Output:
 - Alternating current, 50/60 Hz, 10' (3 m) input power cord
 - Voltage, maximum current, and inlet/plug type varies per model (see ordering table)
- Power Output:
 - NEMA 5-20R, Locking IEC C13 and/or IEC C19 Outlets, specific to PDU with up to 54 outlets (see order table)
- Mounting:
 - Vertical PDUs: 2 preinstalled tool-less mounting buttons; adjustable positions; Top or bottom power cord entry orientation
 - Horizontal PDUs: Include rack-mount brackets for 19"EIA (482.6 mm) racks
- Bonding/Grounding:
 - Bonded power inlet/plug and external bond connection with a threaded M5 attachment point
 - Includes a bonding kit for CPI cabinets
- Operating Conditions:
 - Temperature: 32°F – 149°F (0°C – 65°C) at Input Power Rating (kW)
 - Relative Humidity: 5% – 95%, noncondensing
 - Elevation: 0 – 10,000 ft (0 – 3,000 m)
- Dimensions:
 - For specific dimensions, download the individual product cut sheets by searching the base part number (ex: Ex-xxxx) on chatsworth.com

Certifications:

- UL/cUL/IEC62368, CE (EU), FCC Part 15, Class A, EN 55022, RoHS Compliant



The Power Selector enables you to select the best power product for your application by narrowing down options based on your requirements. After you're done comparing, you can email or print the results. Visit selectapdu.com to access the Power Selector.

BASIC ECONNECT® PDU, VERTICAL

Basic eConnect PDU, Vertical - North America								
Part Number			Input Amperage	Input Plug	Outlets	kW Capacity (UL)	Cabinet Capacity	
Black*	Glacier White*	Redundancy Pack**						
120 Volt, Single-Phase Input								
EO-1001-C	EO-1001-E	EO-1001-CE	20A	C20 Inlet to L5-20	(24) 5-20	1.9 kW	42U & higher	
EO-1002-C	EO-1002-E	EO-1002-CE	30A	L5-30	(24) 5-20	2.9 kW	42U & higher	
208 Volt, Single-Phase Input								
EO-1003-C	EO-1003-E	EO-1003-CE	20A	C20 Inlet to L6-20	(24) C13	3.3 kW	42U & higher	
EO-1004-C	EO-1004-E	EO-1004-CE	30A	L6-30	(24) C13	5 kW	42U & higher	
EO-1015-C	EO-1015-E	EO-1015-CE	30A	L6-30	(36) C13 + (6) C19	5 kW	42U & higher	
120/208 Volt, Three-Phase Input								
EO-1013-C	EO-1013-E	EO-1013-CE	20A	L21-20	(30) C13 + (6) C19 + (6) 5-20	5.7 kW	42U & higher	
EO-1017-C	EO-1017-E	EO-1017-CE	20A	L21-20	(36) C13 + (6) C19	5.7 kW	42U & higher	
EO-1014-C	EO-1014-E	EO-1014-CE	30A	L21-30	(30) C13 + (6) C19 + (6) 5-20	8.6 kW	42U & higher	
EO-1018-C	EO-1018-E	EO-1018-CE	30A	L21-30	(36) C13 + (6) C19	8.6 kW	42U & higher	
208 Volt, Three-Phase Input								
EO-1016-C	EO-1016-E	EO-1016-CE	30A	L15-30	(36) C13 + (6) C19	8.6 kW	42U & higher	
EO-1007-C	EO-1007-E	EO-1007-CE	50A	CS8365	(30) C13 + (12) C19	14.4 kW	42U & higher	
EO-1019-C	EO-1019-E	EO-1019-CE	50A	CS8365	(36) C13 + (6) C19	14.4 kW	42U & higher	
EO-1125-C	EO-1125-E	EO-1125-CE	50A	CS8365	(54) C13	14.4 kW	45U & higher	
EO-1008-C	EO-1008-E	EO-1008-CE	60A	IEC 60309 60A 3P+E	(30) C13 + (12) C19	17.2 kW	42U & higher	
EO-1020-C	EO-1020-E	EO-1020-CE	60A	IEC 60309 60A 3P+E	(36) C13 + (6) C19	17.2 kW	42U & higher	
EO-1033-C	EO-1033-E	EO-1033-CE	60A	IEC 60309 60A 3P+E	(12) C13 + (18) C19	17.2 kW	42U & higher	
EO-1126-C	EO-1126-E	EO-1126-CE	60A	IEC 60309 60A 3P+E	(54) C13	17.2 kW	45U & higher	
240/415 Volt, Three-Phase Input								
EO-1021-C	EO-1021-E	EO-1021-CE	30A	L22-30	(36) C13 + (6) C19	17.2 kW	42U & higher	
EO-1127-C	EO-1127-E	EO-1127-CE	30A	L22-30	(54) C13	17.2 kW	45U & higher	

Basic eConnect PDU, Vertical - Worldwide								
Part Number			Input Amperage	Input Plug	Outlets	kW Capacity Worldwide (CE)	kW Capacity North America (UL)	Cabinet Capacity
Black*	Glacier White*	Redundancy Pack**						
220 - 240 Volt, Single-Phase Input								
EO-1005-C	EO-1005-E	EO-1005-CE	16A	C20 Inlet to IEC 60309 16A 1P+N+E	(24) C13	3.8 kW	3.8 kW	42U & higher
EO-1006-C	EO-1006-E	EO-1006-CE	32A	IEC 60309 32A 1P+N+E	(24) C13	7.7 kW	6.1 kW	42U & higher
EO-1022-C	EO-1022-E	EO-1022-CE	32A	IEC 60309 32A 1P+N+E	(36) C13 + (6) C19	7.7 kW	6.1 kW	42U & higher
220-240/380-415 Volt, Three-Phase Input								
EO-1023-C	EO-1023-E	EO-1023-CE	16/20A	IEC 60309 16/20A 3P+N+E	(36) C13 + (6) C19	11.5 kW	11.5 kW	42U & higher
EO-1009-C	EO-1009-E	EO-1009-CE	32A	IEC 60309 32A 3P+N+E	(30) C13 + (12) C19	23 kW	18.4 kW	42U & higher
EO-1024-C	EO-1024-E	EO-1024-CE	32A	IEC 60309 32A 3P+N+E	(36) C13 + (6) C19	23 kW	18.4 kW	42U & higher
EO-1128-C	EO-1128-E	EO-1128-CE	32A	IEC 60309 32A 3P+N+E	(54) C13	23 kW	18.4 kW	45U & higher

Notes: *Shipping weight for each unit is 27 lb (12 kg). **Redundancy Pack includes 2 PDUs in Black and Glacier White for easy identification of the primary and secondary unit; shipping weight is 54 lb (24 kg).

BASIC ECONNECT® PDU, HORIZONTAL

Basic eConnect PDU, Horizontal - North America							
Part Number			Input Amperage	Input Plug	Outlets	kW Capacity (UL)	Form Factor (U) Height
Black*	Glacier White*	Redundancy Pack**					
120 Volt, Single-Phase Input							
E0-1243-C	E0-1243-E	E0-1243-CE	20A	C20 Inlet to L5-20	(12) 5-20	1.9 kW	1U
E0-1244-C	E0-1244-E	E0-1244-CE	30A	NEMA L5-30P	(12) 5-20	2.9 kW	1U
208 Volt, Single-Phase Input							
E0-1245-C	E0-1245-E	E0-1245-CE	20A	C20 Inlet to L6-20	(12) C13	3.3 kW	1U
E0-1270-C	E0-1270-E	E0-1270-CE	20A	C20 Inlet to L6-20	(8) C13 + (4) C19	3.3 kW	1U
E0-1246-C	E0-1246-E	E0-1246-CE	30A	NEMA L6-30P	(12) C13	5 kW	1U
E0-1253-C	E0-1253-E	E0-1253-CE	30A	NEMA L6-30P	(9) C19	5 kW	1U
E0-1271-C	E0-1271-E	E0-1271-CE	30A	NEMA L6-30P	(8) C13 + (4) C19	5 kW	1U
120/208 Volt, Three-Phase Input							
E0-1248-C	E0-1248-E	E0-1248-CE	20A	NEMA L21-20P	(12) C13	5.7 kW	1U
E0-1255-C	E0-1255-E	E0-1255-CE	20A	NEMA L21-20P	(9) C19	5.7 kW	1U
E0-1273-C	E0-1273-E	E0-1273-CE	20A	NEMA L21-20P	(8) C13 + (4) C19	5.7 kW	1U
E0-1249-C	E0-1249-E	E0-1249-CE	30A	NEMA L21-30P	(12) C13	8.6 kW	1U
E0-1256-C	E0-1256-E	E0-1256-CE	30A	NEMA L21-30P	(9) C19	8.6 kW	1U
E0-1274-C	E0-1274-E	E0-1274-CE	30A	NEMA L21-30P	(8) C13 + (4) C19	8.6 kW	1U
208 Volt, Three-Phase Input							
E0-1247-C	E0-1247-E	E0-1247-CE	30A	NEMA L15-30P	(12) C13	8.6 kW	1U
E0-1254-C	E0-1254-E	E0-1254-CE	30A	NEMA L15-30P	(9) C19	8.6 kW	1U
E0-1272-C	E0-1272-E	E0-1272-CE	30A	NEMA L15-30P	(8) C13 + (4) C19	8.6 kW	1U

Basic eConnect PDU, Horizontal - Worldwide								
Part Number			Input Amperage	Input Plug	Outlets	kW Capacity (CE)	kW Capacity North America (UL)	Form Factor (U) Height
Black*	Glacier White*	Redundancy Pack**						
220 - 240 Volt, Single-Phase Input								
E0-1250-C	E0-1250-E	E0-1250-CE	16A	C20 Inlet to IEC 60309 16A 1P+N+E	(12) C13	3.8 kW	3.8 kW	1U
E0-1275-C	E0-1275-E	E0-1275-CE	16A	C20 Inlet to IEC 60309 16A 1P+N+E	(8) C13 + (4) C19	3.8 kW	3.8 kW	1U
E0-1252-C	E0-1252-E	E0-1252-CE	32A	IEC 60309 32A 1P+N+E	(12) C13	7.7 kW	6.1 kW	1U
E0-1257-C	E0-1257-E	E0-1257-CE	32A	IEC 60309 32A 1P+N+E	(9) C19	7.7 kW	6.1 kW	1U
E0-1277-C	E0-1277-E	E0-1277-CE	32A	IEC 60309 32A 1P+N+E	(8) C13 + (4) C19	7.7 kW	6.1 kW	1U
220 - 240/380-415 Volt, Three-Phase Input								
E0-1251-C	E0-1251-E	E0-1251-CE	16/20A	IEC 60309 16/20A 3P+N+E	(12) C13	11.5 kW	11.5 kW	1U
E0-1258-C	E0-1258-E	E0-1258-CE	16/20A	IEC 60309 16/20A 3P+N+E	(9) C19	11.5 kW	11.5 kW	1U
E0-1276-C	E0-1276-E	E0-1276-CE	16/20A	IEC 60309 16/20A 3P+N+E	(8) C13 + (4) C19	11.5 kW	11.5 kW	1U

Notes: *Shipping weight for each unit is 18 lb (8.2 kg); **Redundancy Pack includes 2 PDUs in Black and Glacier White for easy identification of the primary and secondary unit; shipping weight is 35 lb (15.9 kg)



The Power Selector enables you to select the best power product for your application by narrowing down options based on your requirements. After you're done comparing, you can email or print the results. Visit selectapdu.com to access the Power Selector.

BASIC ECONNECT® PDU, HORIZONTAL

Basic eConnect PDU, Horizontal - North America								
Part Number			Input Amperage	Input Plug	Outlets	kW Capacity (UL)	Form Factor (U) Height	
Black*	Glacier White*	Redundancy Pack**						
120 Volt, Single-Phase Input								
EO-1401-C	EO-1401-E	EO-1401-CE	20A	C20 Inlet to L5-20	(24) 5-20	1.9 kW		2U
EO-1402-C	EO-1402-E	EO-1402-CE	30A	NEMA L5-30P	(24) 5-20	2.9 kW		2U
208 Volt, Single-Phase Input								
EO-1403-C	EO-1403-E	EO-1403-CE	20A	C20 Inlet to L6-20	(24) C13	3.3 kW		2U
EO-1459-C	EO-1459-E	EO-1459-CE	20A	C20 Inlet to L6-20	(18) C13 + (6) C19	3.3 kW		2U
EO-1404-C	EO-1404-E	EO-1404-CE	30A	NEMA L6-30P	(24) C13	5 kW		2U
EO-1461-C	EO-1461-E	EO-1461-CE	30A	NEMA L6-30P	(18) C13 + (6) C19	5 kW		2U
EO-1478-C	EO-1478-E	EO-1478-CE	30A	NEMA L6-30P	(6) C13 + (12) C19	5 kW		2U
120/208 Volt, Single-Phase Input								
EO-1469-C	EO-1469-E	EO-1469-CE	30A	NEMA L14-30P	(12) C13 + (6) C19 + (4) 5-20	5 kW		2U
120/208 Volt, Three-Phase Input								
EO-1439-C	EO-1439-E	EO-1439-CE	20A	NEMA L21-20P	(24) C13	5.7 kW		2U
EO-1463-C	EO-1463-E	EO-1463-CE	20A	NEMA L21-20P	(18) C13 + (6) C19	5.7 kW		2U
EO-1480-C	EO-1480-E	EO-1480-CE	20A	NEMA L21-20P	(6) C13 + (12) C19	5.7 kW		2U
EO-1467-C	EO-1467-E	EO-1467-CE	20A	NEMA L21-20P	(12) C13 + (6) C19 + (4) 5-20	5.7 kW		2U
EO-1440-C	EO-1440-E	EO-1440-CE	30A	NEMA L21-30P	(24) C13	8.6 kW		2U
EO-1464-C	EO-1464-E	EO-1464-CE	30A	NEMA L21-30P	(18) C13 + (6) C19	8.6 kW		2U
EO-1482-C	EO-1482-E	EO-1482-CE	30A	NEMA L21-30P	(6) C13 + (12) C19	8.6 kW		2U
EO-1468-C	EO-1468-E	EO-1468-CE	30A	NEMA L21-30P	(12) C13 + (6) C19 + (4) 5-20	8.6 kW		2U
208 Volt, Three-Phase Input								
EO-1441-C	EO-1441-E	EO-1441-CE	30A	NEMA L15-30P	(24) C13	8.6 kW		2U
EO-1465-C	EO-1465-E	EO-1465-CE	30A	NEMA L15-30P	(18) C13 + (6) C19	8.6 kW		2U
EO-1483-C	EO-1483-E	EO-1483-CE	30A	NEMA L15-30P	(6) C13 + (12) C19	8.6 kW		2U
EO-1484-C	EO-1484-E	EO-1484-CE	50A	CS8365	(6) C13 + (12) C19	14.4 kW		2U
EO-1485-C	EO-1485-E	EO-1485-CE	60A	IEC 60309 60A 3P+E	(6) C13 + (12) C19	17.2 kW		2U
Basic eConnect PDU, Horizontal - Worldwide								
Part Number			Input Amperage	Input Plug	Outlets	kW Capacity (CE)	kW Capacity North America (UL)	Form Factor (U) Height
Black*	Glacier White*	Redundancy Pack**						
220 - 240 Volt, Single-Phase Input								
EO-1405-C	EO-1405-E	EO-1405-CE	16A	C20 Inlet to IEC 60309 16A 1P+N+E	(24) C13	3.8 kW	3.8 kW	2U
EO-1460-C	EO-1460-E	EO-1460-CE	16A	C20 Inlet to IEC 60309 16A 1P+N+E	(18) C13 + (6) C19	3.8 kW	3.8 kW	2U
EO-1406-C	EO-1406-E	EO-1406-CE	32A	IEC 60309 32A 1P+N+E	(24) C13	7.7 kW	6.1 kW	2U
EO-1462-C	EO-1462-E	EO-1462-CE	32A	IEC 60309 32A 1P+N+E	(18) C13 + (6) C19	7.7 kW	6.1 kW	2U
EO-1479-C	EO-1479-E	EO-1479-CE	32A	IEC 60309 32A 1P+N+E	(6) C13 + (12) C19	7.7 kW	6.1 kW	2U
220 - 240/380-415 Volt, Three-Phase Input								
EO-1442-C	EO-1442-E	EO-1442-CE	16/20A	IEC 60309 16/20A 3P+N+E	(24) C13	11.5 kW	11.5 kW	2U
EO-1466-C	EO-1466-E	EO-1466-CE	16/20A	IEC 60309 16/20A 3P+N+E	(18) C13 + (6) C19	11.5 kW	11.5 kW	2U
EO-1481-C	EO-1481-E	EO-1481-CE	16/20A	IEC 60309 16/20A 3P+N+E	(6) C13 + (12) C19	11.5 kW	11.5 kW	2U
EO-1486-C	EO-1486-E	EO-1486-CE	32A	IEC 60309 32A 3P+N+E	(6) C13 + (12) C19	23 kW	18.4 kW	2U

Notes: *Shipping weight for each unit is 23 lb (10.4 kg); **Redundancy Pack includes 2 PDUs in Black and Glacier White for easy identification of the primary and secondary unit; shipping weight is 45 lb (20.4 kg)



Metered eConnect PDUs feature a local display for easy reading of input current to help with initial installation and properly balanced operations.

Resistance to High Temperature

Market-leading temperature ratings of up to 149°F (65°C) ensures reliability when mounted toward hot aisles

Simplified Load Balancing

Phase-balance outlets on three-phase models ensure equal loading across all phases; allows use of shorter equipment power cords for better cable and airflow management

No Accidental Disconnections

Patented, low-profile locking outlets prevent accidental disconnections without requiring special cords

Easy Identification of Failover Unit

Redundancy Pack includes 2 PDUs (one in Black and one in Glacier White) for easy identification of the primary and secondary unit

Latest UL Compliance

Meets UL and IEC 62368 for compliance with new listing requirements for North America and the European Union

Cabinet Preinstallation

Complete ecosystem ships ready for IT equipment integration. Saves deployment time and reduces packaging waste.

Metered eConnect PDU

Additional Features:

- Input current metering across phases through LED display
- Breakers and outlet groups are color-coded in multi-breaker units for easy identification
- Universal tool-less mounting features
- Customization capabilities: outlet configurations, color options, power cord length, input connection types and more
- Made in the United States, TAA-compliant

Specifications:

- **Circuit Protection:**
 - UL 489 listed, single- or two-pole, hydraulic-magnetic breakers available on single- and three-phase models with 30A and above input
 - 10kAIC breakers on 220-240/380-415 VAC models; 5kAIC for all other models
 - Low-profile design prevents accidental discharge
- **Metering**
 - Input line currents
 - Display: 4-digit LED, displays input current for all phases; typical accuracy of +/-2%
- **Power Output:**
 - Alternating current, 50/60 Hz, 10' (3 m) input power cord
 - Voltage, maximum current, and inlet/plug type varies per model (see ordering table)
- **Power Output:**
 - NEMA 5-20R, Locking IEC C13 and/or IEC C19 Outlets, specific to PDU with up to 54 outlets (see order table)
- **Mounting:**
 - 2 preinstalled toolless mounting buttons; adjustable positions
 - Top or bottom power cord entry orientation
- **Bonding/Grounding**
 - Bonded power inlet/plug and external bond connection with a threaded M5 attachment point
 - Includes a bonding kit for CPI cabinets
- **Operating Conditions:**
 - Temperature: 32°F – 149°F (0°C – 65°C) at Input Power Rating (kW)
 - Relative Humidity: 5% – 95%, noncondensing
 - Elevation: 0 – 10,000 ft (0 – 3,000 m)
 - Dimensions:
 - For specific dimensions, download the individual product cut sheets by searching the base part number (ex: Ex-xxxx) on chatsworth.com

Certifications:

- UL/cUL/IEC62368, CE (EU), FCC Part 15, Class A, EN 55022, RoHS Compliant



The Power Selector enables you to select the best power product for your application by narrowing down options based on your requirements. After you're done comparing, you can email or print the results. Visit selectapdu.com to access the Power Selector.

Metered eConnect PDU, Vertical - North America							
Part Number			Input Amperage	Input Plug	Outlets	kW Capacity (UL)	Cabinet Capability
Black*	Glacier White*	Redundancy Pack**					
120 Volt, Single-Phase Input							
E1-2001-C	E1-2001-E	E1-2001-CE	20A	C20 Inlet to L5-20	(24) 5-20	1.9 kW	42U & higher
E1-2002-C	E1-2002-E	E1-2002-CE	30A	L5-30	(24) 5-20	2.9 kW	42U & higher
208 Volt, Single-Phase Input							
E1-2003-C	E1-2003-E	E1-2003-CE	20A	C20 Inlet to L6-20	(24) C13	3.3 kW	42U & higher
E1-2004-C	E1-2004-E	E1-2004-CE	30A	L6-30	(24) C13	5 kW	42U & higher
E1-2015-C	E1-2015-E	E1-2015-CE	30A	L6-30	(36) C13 + (6) C19	5 kW	42U & higher
208 Volt, Three-Phase Input							
E1-2016-C	E1-2016-E	E1-2016-CE	30A	L15-30	(36) C13 + (6) C19	8.6 kW	42U & higher
E1-2007-C	E1-2007-E	E1-2007-CE	50A	CS8365	(30) C13 + (12) C19	14.4 kW	42U & higher
E1-2019-C	E1-2019-E	E1-2019-CE	50A	CS8365	(36) C13 + (6) C19	14.4 kW	42U & higher
E1-2125-C	E1-2125-E	E1-2125-CE	50A	CS8365	(54) C13	14.4 kW	45U & higher
E1-2008-C	E1-2008-E	E1-2008-CE	60A	IEC 60309 60A 3P+E	(30) C13 + (12) C19	17.2 kW	42U & higher
E1-2020-C	E1-2020-E	E1-2020-CE	60A	IEC 60309 60A 3P+E	(36) C13 + (6) C19	17.2 kW	42U & higher
E1-2126-C	E1-2126-E	E1-2026-CE	60A	IEC 60309 60A 3P+E	(54) C13	17.2 kW	45U & higher
E1-2033-C	E1-2033-E	E1-2033-CE	60A	IEC 60309 60A 3P+E	(12) C13 + (18) C19	17.2 kW	42U & higher
120/208 Volt, Three-Phase Input							
E1-2013-C	E1-2013-E	E1-2013-CE	20A	L21-20	(30) C13 + (6) C19 + (6) 5-20	5.7 kW	42U & higher
E1-2017-C	E1-2017-E	E1-2017-CE	20A	L21-20	(36) C13 + (6) C19	5.7 kW	42U & higher
E1-2014-C	E1-2014-E	E1-2014-CE	30A	L21-30	(30) C13 + (6) C19 + (6) 5-20	8.6 kW	42U & higher
E1-2018-C	E1-2018-E	E1-2018-CE	30A	L21-30	(36) C13 + (6) C19	8.6 kW	42U & higher
240/415 Volt, Three-Phase Input							
E1-2021-C	E1-2021-E	E1-2021-CE	30A	L22-30	(36) C13 + (6) C19	17.2 kW	42U & higher
E1-2127-C	E1-2127-E	E1-2127-CE	30A	L22-30	(54) C13	17.2 kW	45U & higher

Metered eConnect PDU, Vertical - Worldwide								
Part Number			Input Amperage	Input Plug	Outlets	kW Capacity Worldwide (CE)	kW Capacity North America (UL)	Cabinet Capability
Black*	Glacier White*	Redundancy Pack**						
220 - 240 Volt, Single-Phase Input								
E1-2005-C	E1-2005-E	E1-2005-CE	16A	C20 Inlet to IEC 60309 16A 1P+N+E	(24) C13	3.8 kW	3.8 kW	42U & higher
E1-2006-C	E1-2006-E	E1-2006-CE	32A	IEC 60309 32A 1P+N+E	(24) C13	7.7 kW	6.1 kW	42U & higher
E1-2022-C	E1-2022-E	E1-2022-CE	32A	IEC 60309 32A 1P+N+E	(18) C13 + (6) C19	7.7 kW	6.1 kW	42U & higher
220-240/380-415 Volt, Three-Phase Input								
E1-2023-C	E1-2023-E	E1-2023-CE	16/20A	IEC 60309 16/20A 3P+N+E	(36) C13 + (6) C19	11.5 kW	11.5 kW	42U & higher
E1-2009-C	E1-2009-E	E1-2009-CE	32A	IEC 60309 32A 3P+N+E	(30) C13 + (12) C19	23 kW	18.4 kW	42U & higher
E1-2024-C	E1-2024-E	E1-2024-CE	32A	IEC 60309 32A 3P+N+E	(36) C13 + (6) C19	23 kW	18.4 kW	42U & higher
E1-2128-C	E1-2128-E	E1-2128-CE	32A	IEC 60309 32A 3P+N+E	(54) C13	23 kW	18.4 kW	45U & higher

Notes: *Shipping weight for each unit is 27 lb (12 kg). **Redundancy Pack includes 2 PDUs in Black and Glacier White for easy identification of the primary and secondary unit; shipping weight is 54 lb (24 kg).



Vertical and Horizontal Options Available



Monitored eConnect PDUs provide remote power monitoring to the input and branch circuit level, making it possible to obtain and manage power consumption at the cabinet level.

Reduced Networking Costs and Complexity

Secure Array® allows the use of a single IP address for up to 48 connected PDUs (32 when electronic locks are integrated). Second IP address for the entire array provides failover capability

Simplified Load Balancing

Phase-balance outlets on three-phase models ensure equal loading across all phases; allows use of shorter equipment power cords for better cable and airflow management

No Accidental Disconnections

Patented, low-profile locking outlets prevent accidental disconnections without requiring special cords

Electronic Lock Integration

Patented technology seamlessly integrates PDU, environmental sensors and electronic locks into a single hardware and software solution

Gigabit Ethernet

Ensures compatibility with enterprise routers and switches

Cabinet Preinstallation

Complete ecosystem ships ready for IT equipment integration. Saves deployment time and reduces packaging waste.

Monitored eConnect PDU

Additional Features:

- Input and branch circuit monitoring with billing-grade +/-1% accuracy
- Field-replaceable controller module for easy serviceability and upgradeability while maintaining power to critical loads; SD-card transfers PDU configuration
- Onboard GUI, RESTful API, SNMP v1/v2/v3, Command Line Interface (CLI), and native Power IQ® DCIM software integration allows users to easily manage PDUs
- Zero Touch Provisioning (ZTP) automates configuration and provisioning of large deployments of PDUs.
- HTTPs support, RADIUS and LDAP integration for enhanced authentication and security
- Customization capabilities: outlet configurations, color options, power cord length, input connection types and more
- Made in the United States, TAA-compliant

Specifications:

- Single-input, vertical and horizontal rack-mount PDUs
- Circuit Protection:
 - UL 489 listed, single- or two-pole, hydraulic-magnetic breakers available on single- and three-phase models with 30A and above input
 - 10kAIC breakers on 220-240/380-415 VAC models; 5kAIC for all other models
 - Low-profile design prevents accidental discharge
- Metering:
 - Input line currents
 - Voltage, current, power, energy and power factor at branch circuits
 - +/- 1% billing-grade
- Networking:
 - 10/100/1000MB Ethernet Port
 - Secure Array IP Consolidation for up to 48 PDUs with no integrated electronic locks or 32 PDUs with integrated electronic locks
 - Secure Array IP Consolidation supports alternate/failover network connection through a second PDU
- Console Access:
 - Through serial console port connection and Command Line Interface (CLI)
- Controller:
 - Field-replaceable module; SD-card transfers PDU configuration
- Firmware:
 - Flash upgradeable through USB port, Web interface, CLI, API or PowerIQ
- Electronic Lock Integration:
 - Front and rear cabinet door locks (ordered separately) connected to AUX ports on the PDU
 - Door locks are powered from and remotely accessed through the PDU
- Mounting:
 - Vertical PDUs: 2 preinstalled tool-less mounting buttons; adjustable positions; Top or bottom power cord entry orientation
 - Horizontal PDUs: Include rack-mount brackets for 19"EIA (482.6 mm) racks
- Dimensions:
 - For specific dimensions, download the individual product cut sheets by searching the base part number (ex: Ex-xxxx) on chatsworth.com

Certifications:

- UL/cUL/IEC62368, CE (EU), FCC Part 15, Class A, EN 55022, RoHS Compliant



The Power Selector enables you to select the best power product for your application by narrowing down options based on your requirements. After you're done comparing, you can email or print the results. Visit selectapdu.com to access the Power Selector.

MONITORED ECONNECT® PDU, VERTICAL

Monitored eConnect PDU, Vertical - North America								
Part Number			Input Amperage	Input Plug	Outlets	kW Capacity (UL)	Cabinet Capability	
Black*	Glacier White*	Redundancy Pack**						
120 Volt, Single-Phase Input								
EA-3001-C	EA-3001-E	EA-3001-CE	20A	C20 Inlet to L5-20	(24) 5-20	1.9 kW	42U & higher	
EA-3002-C	EA-3002-E	EA-3002-CE	30A	L5-30	(24) 5-20	2.9 kW	42U & higher	
208 Volt, Single-Phase Input								
EA-3003-C	EA-3003-E	EA-3003-CE	20A	C20 Inlet to L6-20	(24) C13	3.3 kW	42U & higher	
EA-3004-C	EA-3004-E	EA-3004-CE	30A	L6-30	(24) C13	5 kW	42U & higher	
EA-3015-C	EA-3015-E	EA-3015-CE	30A	L6-30	(36) C13 + (6) C19	5 kW	42U & higher	
120/208 Volt, Single-Phase Input								
EA-3087-C	EA-3087-E	EA-3087-CE	30A	L14-30	(30) C13 + (6) C19 + (6) 5-20	5 kW	42U & higher	
120/208 Volt, Three-Phase Input								
EA-3013-C	EA-3013-E	EA-3013-CE	20A	L21-20	(30) C13 + (6) C19 + (6) 5-20	5.7 kW	42U & higher	
EA-3017-C	EA-3017-E	EA-3017-CE	20A	L21-20	(36) C13 + (6) C19	5.7 kW	42U & higher	
EA-3014-C	EA-3014-E	EA-3014-CE	30A	L21-30	(30) C13 + (6) C19 + (6) 5-20	8.6 kW	42U & higher	
EA-3018-C	EA-3018-E	EA-3018-CE	30A	L21-30	(36) C13 + (6) C19	8.6 kW	42U & higher	
208 Volt, Three-Phase Input								
EA-3016-C	EA-3016-E	EA-3016-CE	30A	L15-30	(36) C13 + (6) C19	8.6 kW	42U & higher	
EA-3007-C	EA-3007-E	EA-3007-CE	50A	CS8365	(30) C13 + (12) C19	14.4 kW	42U & higher	
EA-3019-C	EA-3019-E	EA-3019-CE	50A	CS8365	(36) C13 + (6) C19	14.4 kW	42U & higher	
EA-3125-C	EA-3125-E	EA-3125-CE	50A	CS8365	(54) C13	14.4 kW	45U & higher	
EA-3126-C	EA-3126-E	EA-3126-CE	50A	CS8365	(54) C13	17.2 kW	45U & higher	
EA-3008-C	EA-3008-E	EA-3008-CE	60A	IEC 60309 60A 3P+E	(30) C13 + (12) C19	17.2 kW	42U & higher	
EA-3020-C	EA-3020-E	EA-3020-CE	60A	IEC 60309 60A 3P+E	(36) C13 + (6) C19	17.2 kW	42U & higher	
EA-3033-C	EA-3033-E	EA-3033-CE	60A	IEC 60309 60A 3P+E	(12) C13 + (18) C19	17.2 kW	42U & higher	
240/415 Volt, Three-Phase Input								
EA-3021-C	EA-3021-E	EA-3021-CE	30A	L22-30	(36) C13 + (6) C19	17.2 kW	42U & higher	
EA-3127-C	EA-3127-E	EA-3127-CE	30A	L22-30	(54) C13	17.2 kW	45U & higher	
Monitored eConnect PDU, Vertical - Worldwide								
Part Number			Input Amperage	Input Plug	Outlets	kW Capacity Worldwide (CE)	kW Capacity North America (UL)	Cabinet Capability
Black*	Glacier White*	Redundancy Pack**						
220 - 240 Volt, Single-Phase Input								
EA-3005-C	EA-3005-E	EA-3005-CE	16A	C20 Inlet to IEC 60309 16A 1P+N+E	(24) C13	3.8kW	3.8kW	42U & higher
EA-3006-C	EA-3006-E	EA-3006-CE	32A	C20 Inlet to IEC 60309 32A 1P+N+E	(24) C13	7.7 kW	6.1 kW	42U & higher
EA-3022-C	EA-3022-E	EA-3022-CE	32A	C20 Inlet to IEC 60309 32A 1P+N+E	(36) C13 + (6) C19	7.7 kW	6.1 kW	42U & higher
220-240/380-415 Volt, Three-Phase Input								
EA-3023-C	EA-3023-E	EA-3023-CE	16/20A	IEC 60309 16/20A 3P+N+E	(36) C13 + (6) C19	11.5 kW	11.5 kW	42U & higher
EA-3009-C	EA-3009-E	EA-3009-CE	32A	IEC 60309 32A 3P+N+E	(30) C13 + (12) C19	23 kW	18.4 kW	42U & higher
EA-3024-C	EA-3024-E	EA-3024-CE	32A	IEC 60309 32A 3P+N+E	(36) C13 + (6) C19	23 kW	18.4 kW	42U & higher
EA-3128-C	EA-3128-E	EA-3128-CE	32A	IEC 60309 20A 3P+N+E	(54) C13	23 kW	18.4 kW	45U & higher

Notes: *Shipping weight for each unit is 27 lb (12 kg). **Redundancy Pack includes 2 PDUs in Black and Glacier White for easy identification of the primary and secondary unit; shipping weight is 54 lb (24 kg).

MONITORED ECONNECT®PDU, HORIZONTAL

Monitored eConnect PDU, Horizontal - North America							
Part Number			Input Amperage	Input Plug	Outlets	kW Capacity (UL)	Form Factor (U) Height
Black*	Glacier White*	Redundancy Pack**					
120 Volt, Single-Phase Input							
EA-3243-C	EA-3243-E	EA-3243-CE	20A	C20 Inlet to L5-20	(12) 5-20	1.9 kW	1U
EA-3244-C	EA-3244-E	EA-3244-CE	30A	NEMA L5-30P	(12) 5-20	2.9 kW	1U
208 Volt, Single-Phase Input							
EA-3245-C	EA-3245-E	EA-3245-CE	20A	C20 Inlet to L6-20	(12) C13	3.3 kW	1U
EA-3270-C	EA-3270-E	EA-3270-CE	20A	C20 Inlet to L6-20	(8) C13 + (4) C19	3.3 kW	1U
EA-3246-C	EA-3246-E	EA-3246-CE	30A	NEMA L6-30P	(12) C13	5 kW	1U
EA-3253-C	EA-3253-E	EA-3253-CE	30A	NEMA L6-30P	(9) C19	5 kW	1U
EA-3271-C	EA-3271-E	EA-3271-CE	30A	NEMA L6-30P	(8) C13 + (4) C19	5 kW	1U
120/208 Volt, Three-Phase Input							
EA-3248-C	EA-3248-E	EA-3248-CE	20A	NEMA L21-20P	(12) C13	5.7 kW	1U
EA-3255-C	EA-3255-E	EA-3255-CE	20A	NEMA L21-20P	(9) C19	5.7 kW	1U
EA-3273-C	EA-3273-E	EA-3273-CE	20A	NEMA L21-20P	(8) C13 + (4) C19	5.7 kW	1U
EA-3249-C	EA-3249-E	EA-3249-CE	30A	NEMA L21-30P	(12) C13	8.6 kW	1U
EA-3256-C	EA-3256-E	EA-3256-CE	30A	NEMA L21-30P	(9) C19	8.6 kW	1U
EA-3274-C	EA-3274-E	EA-3274-CE	30A	NEMA L21-30P	(8) C13 + (4) C19	8.6 kW	1U
208 Volt, Three-Phase Input							
EA-3247-C	EA-3247-E	EA-3247-CE	30A	NEMA L15-30P	(12) C13	8.6 kW	1U
EA-3254-C	EA-3254-E	EA-3254-CE	30A	NEMA L15-30P	(9) C19	8.6 kW	1U
EA-3272-C	EA-3272-E	EA-3272-CE	30A	NEMA L15-30P	(8) C13 + (4) C19	8.6 kW	1U

Monitored eConnect PDU, Horizontal - Worldwide								
Part Number			Input Amperage	Input Plug	Outlets	kW Capacity (CE)	kW Capacity North America (UL)	Form Factor (U) Height
Black*	Glacier White*	Redundancy Pack**						
220 - 240 Volt, Single-Phase Input								
EA-3250-C	EA-3250-E	EA-3250-CE	16A	C20 Inlet to IEC 60309 16A 1P+N+E	(12) C13	3.8 kW	3.8 kW	1U
EA-3275-C	EA-3275-E	EA-3275-CE	16A	C20 Inlet to IEC 60309 16A 1P+N+E	(8) C13 + (4) C19	3.8 kW	3.8 kW	1U
EA-3252-C	EA-3252-E	EA-3252-CE	32A	IEC 60309 32A 1P+N+E	(12) C13	7.7 kW	6.1 kW	1U
EA-3257-C	EA-3257-E	EA-3257-CE	32A	IEC 60309 32A 1P+N+E	(9) C19	7.7 kW	6.1 kW	1U
EA-3277-C	EA-3277-E	EA-3277-CE	32A	IEC 60309 32A 1P+N+E	(8) C13 + (4) C19	7.7 kW	6.1 kW	1U
220 - 240/380-415 Volt, Three-Phase Input								
EA-3251-C	EA-3251-E	EA-3251-CE	16/20A	IEC 60309 16/20A 3P+N+E	(12) C13	11.5 kW	11.5 kW	1U
EA-3258-C	EA-3258-E	EA-3258-CE	16/20A	IEC 60309 16/20A 3P+N+E	(9) C19	11.5 kW	11.5 kW	1U
EA-3276-C	EA-3276-E	EA-3276-CE	16/20A	IEC 60309 16/20A 3P+N+E	(8) C13 + (4) C19	11.5 kW	11.5 kW	1U

Notes: *Shipping weight for each unit is 18 lb (8.2 kg) **Redundancy Pack includes 2 PDUs in Black and Glacier White for easy identification of the primary and secondary unit; shipping weight is 35 lb (15.9 kg)

MONITORED ECONNECT®PDU, HORIZONTAL

Monitored eConnect PDU, Horizontal - North America								
Part Number			Input Amperage	Input Plug	Outlets	kW Capacity (UL)	Form Factor (U) Height	
Black*	Glacier White*	Redundancy Pack**						
120 Volt, Single-Phase Input								
EA-3401-C	EA-3401-E	EA-3401-CE	20A	C20 Inlet to L5-20	(24) 5-20	1.9 kW		2U
EA-3402-C	EA-3402-E	EA-3402-CE	30A	NEMA L5-30P	(24) 5-20	2.9 kW		2U
208 Volt, Single-Phase Input								
EA-3403-C	EA-3403-E	EA-3403-CE	20A	C20 Inlet to L6-20	(24) C13	3.3 kW		2U
EA-3459-C	EA-3459-E	EA-3459-CE	20A	C20 Inlet to L6-20	(18) C13 + (6) C19	3.3 kW		2U
EA-3404-C	EA-3404-E	EA-3404-CE	30A	NEMA L6-30P	(24) C13	5 kW		2U
EA-3461-C	EA-3461-E	EA-3461-CE	30A	NEMA L6-30P	(18) C13 + (6) C19	5 kW		2U
EA-3478-C	EA-3478-E	EA-3478-CE	30A	NEMA L6-30P	(6) C13 + (12) C19	5 kW		2U
120/208 Volt, Single-Phase Input								
EA-3469-C	EA-3469-E	EA-3469-CE	30A	NEMA L14-30P	(12) C13 + (6) C19 + (4) 5-20	5 kW		2U
120/208 Volt, Three-Phase Input								
EA-3439-C	EA-3439-E	EA-3439-CE	20A	NEMA L21-20P	(24) C13	5.7 kW		2U
EA-3463-C	EA-3463-E	EA-3463-CE	20A	NEMA L21-20P	(18) C13 + (6) C19	5.7 kW		2U
EA-3480-C	EA-3480-E	EA-3480-CE	20A	NEMA L21-20P	(6) C13 + (12) C19	5.7 kW		2U
EA-3467-C	EA-3467-E	EA-3467-CE	20A	NEMA L21-20P	(12) C13 + (6) C19 + (4) 5-20	5.7 kW		2U
EA-3440-C	EA-3440-E	EA-3440-CE	30A	NEMA L21-30P	(24) C13	8.6 kW		2U
EA-3464-C	EA-3464-E	EA-3464-CE	30A	NEMA L21-30P	(18) C13 + (6) C19	8.6 kW		2U
EA-3482-C	EA-3482-E	EA-3482-CE	30A	NEMA L21-30P	(6) C13 + (12) C19	8.6 kW		2U
EA-3468-C	EA-3468-E	EA-3468-CE	30A	NEMA L21-30P	(12) C13 + (6) C19 + (4) 5-20	8.6 kW		2U
208 Volt, Three-Phase Input								
EA-3441-C	EA-3441-E	EA-3441-CE	30A	NEMA L15-30P	(24) C13	8.6 kW		2U
EA-3465-C	EA-3465-E	EA-3465-CE	30A	NEMA L15-30P	(18) C13 + (6) C19	8.6 kW		2U
EA-3483-C	EA-3483-E	EA-3483-CE	30A	NEMA L15-30P	(6) C13 + (12) C19	8.6 kW		2U
EA-3484-C	EA-3484-E	EA-3484-CE	50A	CS8365	(6) C13 + (12) C19	14.4 kW		2U
EA-3485-C	EA-3485-E	EA-3485-CE	60A	IEC 60309 60A 3P+E	(6) C13 + (12) C19	17.2 kW		2U
Monitored eConnect PDU, Horizontal - Worldwide								
Part Number			Input Amperage	Input Plug	Outlets	kW Capacity (CE)	kW Capacity North America (UL)	Form Factor (U) Height
Black*	Glacier White*	Redundancy Pack**						
220 - 240 Volt, Single-Phase Input								
EA-3405-C	EA-3405-E	EA-3405-CE	16A	C20 Inlet to IEC 60309 16A 1P+N+E	(24) C13	3.8 kW	3.8 kW	2U
EA-3460-C	EA-3460-E	EA-3460-CE	16A	C20 Inlet to IEC 60309 16A 1P+N+E	(18) C13 + (6) C19	3.8 kW	3.8 kW	2U
EA-3406-C	EA-3406-E	EA-3406-CE	32A	IEC 60309 32A 1P+N+E	(24) C13	7.7 kW	6.1 kW	2U
EA-3462-C	EA-3462-E	EA-3462-CE	32A	IEC 60309 32A 1P+N+E	(18) C13 + (6) C19	7.7 kW	6.1 kW	2U
EA-3479-C	EA-3479-E	EA-3479-CE	32A	IEC 60309 32A 1P+N+E	(6) C13 + (12) C19	7.7 kW	6.1 kW	2U
220 - 240/380-415 Volt, Three-Phase Input								
EA-3442-C	EA-3442-E	EA-3442-CE	16/20A	IEC 60309 16/20A 3P+N+E	(24) C13	11.5 kW	11.5 kW	2U
EA-3466-C	EA-3466-E	EA-3466-CE	16/20A	IEC 60309 16/20A 3P+N+E	(18) C13 + (6) C19	11.5 kW	11.5 kW	2U
EA-3481-C	EA-3481-E	EA-3481-CE	16/20A	IEC 60309 16/20A 3P+N+E	(6) C13 + (12) C19	11.5 kW	11.5 kW	2U
EA-3486-C	EA-3486-E	EA-3486-CE	32A	IEC 60309 32A 3P+N+E	(6) C13 + (12) C19	23 kW	18.4 kW	2U

Notes: *Shipping weight for each unit is 23 lb (10.4 kg); **Redundancy Pack includes 2 PDUs in Black and Glacier White for easy identification of the primary and secondary unit; shipping weight is 45 lb (20.4 kg)



Vertical and Horizontal Options Available



Monitored Pro eConnect PDUs provide remote power monitoring down to the outlet level, making it possible to obtain power consumption for each piece of equipment.

Reduced Networking Costs and Complexity

Secure Array® allows the use of a single IP address for up to 48 connected PDUs (32 when electronic locks are integrated). Second IP address for the entire array provides failover capability

Simplified Load Balancing

Phase-balance outlets on three-phase models ensure equal loading across all phases; allows use of shorter equipment power cords for better cable and airflow management

No Accidental Disconnections

Patented, low-profile locking outlets prevent accidental disconnections without requiring special cords

Electronic Lock Integration

Patented technology seamlessly integrates PDU, environmental sensors and electronic locks into a single hardware and software solution

Gigabit Ethernet

Ensures compatibility with enterprise routers and switches

Cabinet Preinstallation

Complete ecosystem ships ready for IT equipment integration. Saves deployment time and reduces packaging waste.

Monitored Pro eConnect PDU

Additional Features:

- Individual outlet monitoring; outlet grouping
- Field-replaceable controller module for easy serviceability and upgradeability while maintaining power to critical loads; SD-card transfers PDU configuration
- Onboard GUI, RESTful API, SNMP v1/v2/v3, Command Line Interface (CLI), and native Power IQ® DCIM software integration allows users to easily manage PDUs
- Zero Touch Provisioning (ZTP) automates configuration and provisioning of large deployments of PDUs.
- HTTPs support, RADIUS and LDAP integration for enhanced authentication and security
- Customization capabilities: outlet configurations, color options, power cord length, input connection types and more
- Made in the United States, TAA-compliant

Specifications:

- Single-input, vertical and horizontal rack-mount PDUs
- Circuit Protection:
 - UL 489 listed, single- or two-pole, hydraulic-magnetic breakers available on single- and three-phase models with 30A and above input
 - 10kAIC breakers on 220-240/380-415 VAC models; 5kAIC for all other models
 - Low-profile design prevents accidental discharge
- Metering:
 - Input line currents
 - Voltage, current, power, energy and power factor at branch circuits and individual outlets
 - +/- 1% billing-grade
 - Ability to name outlets to identify attached equipment
 - Outlet grouping for power charge back reports
- Networking:
 - 10/100/1000MB Ethernet Port
 - Secure Array IP Consolidation for up to 48 PDUs with no integrated electronic locks or 32 PDUs with integrated electronic locks
 - Secure Array IP Consolidation supports alternate/failover network connection through a second PDU
- Console Access:
 - Through serial console port connection and Command Line Interface (CLI)
- Controller:
 - Field-replaceable module; SD-card transfers PDU configuration
- Firmware:
 - Flash upgradeable through USB port, Web interface, CLI, API or Power IQ
- Electronic Lock Integration:
 - Front and rear cabinet door locks (ordered separately) connected to AUX ports on the PDU
 - Door locks are powered from and remotely accessed through the PDU
- Mounting:
 - Vertical PDUs: 2 preinstalled tool-less mounting buttons; adjustable positions; Top or bottom power cord entry orientation
- Dimensions:
 - For specific dimensions, download the individual product cut sheets by searching the base part number (ex: Ex-xxxx) on chatsworth.com

Certifications:

- UL/cUL/IEC62368, CE (EU), FCC Part 15, Class A, EN 55022, RoHS Compliant

MONITORED PRO ECONNECT® PDU, VERTICAL

Monitored Pro eConnect PDU, Vertical - North America							
Part Number			Input Amperage	Input Plug	Outlets	kW Capacity (UL)	Cabinet Capacity
Black*	Glacier White*	Redundancy Pack**					
120 Volt, Single-Phase Input							
EA-4001-C	EA-4001-E	EA-4001-CE	20A	C20 Inlet to L5-20	(24) 5-20	1.9 kW	42U & higher
EA-4002-C	EA-4002-E	EA-4002-CE	30A	L5-30	(24) 5-20	2.9 kW	42U & higher
208 Volt, Single-Phase Input							
EA-4069-C	EA-4069-E	EA-4069-CE	20A	C20 Inlet to L6-20	(18) C13 + (6) C19	3.3 kW	42U & higher
EA-4070-C	EA-4070-E	EA-4070-CE	20A	C20 Inlet to L6-20	(24) C13	3.3 kW	42U & higher
EA-4004-C	EA-4004-E	EA-4004-CE	30A	L6-30	(24) C13	5 kW	42U & higher
EA-4012-C	EA-4012-E	EA-4012-CE	30A	L6-30	(18) C13 + (6) C19	5 kW	42U & higher
120 - 208 Volt, Three-Phase Input							
EA-4006-C	EA-4006-E	EA-4006-CE	20A	L21-20	(24) C13	5.7 kW	42U & higher
EA-4014-C	EA-4014-E	EA-4014-CE	20A	L21-20	(18) C13 + (6) C19	5.7 kW	42U & higher
EA-4025-C	EA-4025-E	EA-4025-CE	20A	L21-20	(18) C13 + (6) C19 Outlets + (3) 5-20 Convenience Outlets****	5.7 kW	42U & higher
EA-4007-C	EA-4007-E	EA-4007-CE	30A	L21-30	(24) C13	8.6 kW	42U & higher
EA-4015-C	EA-4015-E	EA-4015-CE	30A	L21-30	(18) C13 + (6) C19	8.6 kW	42U & higher
EA-4026-C	EA-4026-E	EA-4026-CE	30A	L21-30	(18) C13 + (6) C19 Outlets + (3) 5-20 Convenience Outlets****	8.6 kW	42U & higher
EA-4035-C	EA-4035-E	EA-4035-CE	30A	L21-30	(36) C13	8.6 kW	42U & higher
208 Volt, Three-Phase Input							
EA-4005-C	EA-4005-E	EA-4005-CE	30A	L15-30	(24) C13	8.6 kW	42U & higher
EA-4013-C	EA-4013-E	EA-4013-CE	30A	L15-30	(18) C13 + (6) C19	8.6 kW	42U & higher
EA-4034-C	EA-4034-E	EA-4034-CE	30A	L15-30	(36) C13	8.6 kW	42U & higher
EA-4016-C	EA-4016-E	EA-4016-CE	50A	CS8365	(18) C13 + (6) C19	14.4 kW	42U & higher
EA-4027-C	EA-4027-E	EA-4027-CE	50A	CS8365	(12) C13 + (12) C19	14.4 kW	42U & higher
EA-4136-C	EA-4136-E	EA-4136-CE	50A	CS8365	(36) C13	14.4kW	45U & higher
EA-4144-C	EA-4144-E	EA-4144-CE	50A	CS8365	(24) C13 + (12) C19	14.4 kW	45U & higher
EA-4017-C	EA-4017-E	EA-4017-CE	60A	IEC 60309 60A 3P+E	(18) C13 + (6) C19	17.2 kW	42U & higher
EA-4028-C	EA-4028-E	EA-4028-CE	60A	IEC 60309 60A 3P+E	(12) C13 + (12) C19	17.2 kW	42U & higher
EA-4137-C	EA-4137-E	EA-4137-CE	60A	IEC 60309 60A 3P+E	(36) C13	17.2 kW	45U & higher
EA-4145-C	EA-4145-E	EA-4145-CE	60A	IEC 60309 60A 3P+E	(24) C13 + (12) C19	17.2 kW	45U & higher
240/415 Volt, Three-Phase Input							
EA-4018-C	EA-4018-E	EA-4018-CE	30A	L22-30	(18) C13 + (6) C19	17.2 kW	42U & higher
EA-4029-C	EA-4029-E	EA-4029-CE	30A	L22-30	(12) C13 + (12) C19	17.2 kW	42U & higher
EA-4038-C	EA-4038-E	EA-4038-CE	30A	L22-30	(36) C13	17.2 kW	42U & higher
EA-4046-C	EA-4046-E	EA-4046-CE	30A	L22-30	(24) C13 + (12) C19	17.2 kW	42U & higher

Notes: *Shipping weight for each unit is 27 lb (12 kg).

**Redundancy Pack includes 2 PDUs in Black and Glacier White for easy identification of the primary and secondary unit; shipping weight is 54 lb (24 kg).

***Convenience outlets do not provide monitoring or switching capabilities.

Monitored Pro eConnect PDU, Vertical - Worldwide								
Part Number			Input Amperage	Input Plug	Outlets	kW Capacity Worldwide (CE)	kW Capacity North America (UL)	Cabinet Capability
Black*	Glacier White*	Redundancy Pack**						
220 - 240 Volt, Single-Phase Input								
EA-4008-C	EA-4008-E	EA-4008-CE	16A	C20 Inlet to IEC 60309 16A 1P+N+E	(24) C13	3.8kW	3.8kW	42U & higher
EA-4019-C	EA-4019-E	EA-4019-CE	16A	C20 Inlet to IEC 60309 16A 1P+N+E	(18) C13 + (6) C19	3.8kW	3.8kW	42U & higher
EA-4009-C	EA-4009-E	EA-4009-CE	32A	IEC 60309 32A 1P+N+E	(24) C13	7.7 kW	6.1kW	42U & higher
EA-4020-C	EA-4020-E	EA-4020-CE	32A	IEC 60309 32A 1P+N+E	(18) C13 + (6) C19	7.7 kW	6.1kW	42U & higher
220-240/380-415 Volt, Three-Phase Input								
EA-4010-C	EA-4010-E	EA-4010-CE	16/20A	IEC 60309 16/20A 3P+N+E	(24) C13	11.5kW	11.5kW	42U & higher
EA-4021-C	EA-4021-E	EA-4021-CE	16/20A	IEC 60309 16/20A 3P+N+E	(18) C13 + (6) C19	11.5kW	11.5kW	42U & higher
EA-4030-C	EA-4030-E	EA-4030-CE	16/20A	IEC 60309 16/20A 3P+N+E	(12) C13 + (12) C19	11.5kW	11.5kW	42U & higher
EA-4039-C	EA-4039-E	EA-4039-CE	16/20A	IEC 60309 16/20A 3P+N+E	(36) C13	11.5kW	11.5kW	42U & higher
EA-4047-C	EA-4047-E	EA-4047-CE	16/20A	IEC 60309 16/20A 3P+N+E	(24) C13 + (12) C19	11.5kW	11.5kW	42U & higher
EA-4022-C	EA-4022-E	EA-4022-CE	32A	IEC 60309 32A 3P+N+E	(18) C13 + (6) C19	23 kW	18.4kW	42U & higher
EA-4031-C	EA-4031-E	EA-4031-CE	32A	IEC 60309 32A 3P+N+E	(12) C13 + (12) C19	23 kW	18.4kW	42U & higher
EA-4040-C	EA-4040-E	EA-4040-CE	32A	IEC 60309 32A 3P+N+E	(36) C13	23 kW	18.4kW	42U & higher
EA-4048-C	EA-4048-E	EA-4048-CE	32A	IEC 60309 32A 3P+N+E	(24) C13 + (12) C19	23 kW	18.4kW	42U & higher

Notes: *Shipping weight for each unit is 27 lb (12 kg).

**Redundancy Pack includes 2 PDUs (one in Black and one in Glacier White) for easy identification of the primary and secondary unit; shipping weight is 54 lb (24 kg).



The Power Selector enables you to select the best power product for your application by narrowing down options based on your requirements. After you're done comparing, you can email or print the results. Visit selectapdu.com to access the Power Selector.

MONITORED PRO ECONNECT®PDU, HORIZONTAL

Monitored Pro eConnect PDU, Horizontal - North America							
Part Number			Input Amperage	Input Plug	Outlets	kW Capacity (UL)	Form Factor (U) Height
Black*	Glacier White*	Redundancy Pack**					
120 Volt, Single-Phase Input							
EA-4274-C	EA-4274-E	EA-4274-CE	20A	C20 Inlet to L5-20	(12) 5-20	1.9 kW	1U
EA-4275-C	EA-4275-E	EA-4275-CE	30A	NEMA L5-30P	(12) 5-20	2.9 kW	1U
208 Volt, Single-Phase Input							
EA-4276-C	EA-4276-E	EA-4276-CE	20A	C20 Inlet to L6-20	(12) C13	3.3 kW	1U
EA-4293-C	EA-4293-E	EA-4293-CE	20A	C20 Inlet to L6-20	(8) C13 + (4) C19	3.3 kW	1U
EA-4277-C	EA-4277-E	EA-4277-CE	30A	NEMA L6-30P	(12) C13	5 kW	1U
EA-4284-C	EA-4284-E	EA-4284-CE	30A	NEMA L6-30P	(9) C19	5 kW	1U
EA-4294-C	EA-4294-E	EA-4294-CE	30A	NEMA L6-30P	(8) C13 + (4) C19	5 kW	1U
120/208 Volt, Three-Phase Input							
EA-4279-C	EA-4279-E	EA-4279-CE	20A	NEMA L21-20P	(12) C13	5.7 kW	1U
EA-4279-C	EA-4279-E	EA-4279-CE	20A	NEMA L21-20P	(12) C13	5.7 kW	1U
EA-4296-C	EA-4296-E	EA-4296-CE	20A	NEMA L21-20P	(8) C13 + (4) C19	5.7 kW	1U
EA-4280-C	EA-4280-E	EA-4280-CE	30A	NEMA L21-30P	(12) C13	8.6 kW	1U
EA-4287-C	EA-4287-E	EA-4287-CE	30A	NEMA L21-30P	(9) C19	8.6 kW	1U
EA-4297-C	EA-4297-E	EA-4297-CE	30A	NEMA L21-30P	(8) C13 + (4) C19	8.6 kW	1U
208 Volt, Three-Phase Input							
EA-4278-C	EA-4278-E	EA-4278-CE	30A	NEMA L15-30P	(12) C13	8.6 kW	1U
EA-4285-C	EA-4285-E	EA-4285-CE	30A	NEMA L15-30P	(9) C19	8.6 kW	1U
EA-4295-C	EA-4295-E	EA-4295-CE	30A	NEMA L15-30P	(8) C13 + (4) C19	8.6 kW	1U

Monitored Pro eConnect PDU, Horizontal - Worldwide								
Part Number			Input Amperage	Input Plug	Outlets	kW Capacity (CE)	kW Capacity North America (UL)	Form Factor (U) Height
Black*	Glacier White*	Redundancy Pack**						
220 - 240 Volt, Single-Phase Input								
EA-4281-C	EA-4281-E	EA-4281-CE	16A	C20 Inlet to IEC 60309 16A 1P+N+E	(12) C13	3.8 kW	3.8 kW	1U
EA-4298-C	EA-4298-E	EA-4298-CE	16A	C20 Inlet to IEC 60309 16A 1P+N+E	(8) C13 + (4) C19	3.8 kW	3.8 kW	1U
EA-4283-C	EA-4283-E	EA-4283-CE	32A	IEC 60309 32A 1P+N+E	(12) C13	7.7 kW	6.1 kW	1U
EA-4289-C	EA-4289-E	EA-4289-CE	32A	IEC 60309 32A 1P+N+E	(9) C19	7.7 kW	6.1 kW	1U
EA-42A0-C	EA-42A0-E	EA-42A0-CE	32A	IEC 60309 32A 1P+N+E	(8) C13 + (4) C19	7.7 kW	6.1 kW	1U
220 - 240/380-415 Volt, Three-Phase Input								
EA-4282-C	EA-4282-E	EA-4282-CE	16/20A	IEC 60309 16/20A 3P+N+E	(12) C13	11.5 kW	11.5 kW	1U
EA-4288-C	EA-4288-E	EA-4288-CE	16/20A	IEC 60309 16/20A 3P+N+E	(9) C19	11.5 kW	11.5 kW	1U
EA-4299-C	EA-4299-E	EA-4299-CE	16/20A	IEC 60309 16/20A 3P+N+E	(8) C13 + (4) C19	11.5 kW	11.5 kW	1U

Notes: *Shipping weight for each unit is 18 lb (8.2 kg). **Redundancy Pack includes 2 PDUs in Black and Glacier White for easy identification of the primary and secondary unit; shipping weight is 35 lb (15.9 kg)

MONITORED PRO ECONNECT®PDU, HORIZONTAL

Monitored Pro eConnect PDU, Horizontal - North America								
Part Number			Input Amperage	Input Plug	Outlets	kW Capacity (UL)	Form Factor (U) Height	
Black*	Glacier White*	Redundancy Pack**						
120 Volt, Single-Phase Input								
EA-4401-C	EA-4401-E	EA-4401-CE	20A	C20 Inlet to L5-20	(24) 5-20	1.9 kW		2U
EA-4402-C	EA-4402-E	EA-4402-CE	30A	NEMA L5-30P	(24) 5-20	2.9 kW		2U
208 Volt, Single-Phase Input								
EA-4470-C	EA-4470-E	EA-4470-CE	20A	C20 Inlet to L6-20	(24) C13	3.3 kW		2U
EA-4469-C	EA-4469-E	EA-4469-CE	20A	C20 Inlet to L6-20	(18) C13 + (6) C19	3.3 kW		2U
EA-4404-C	EA-4404-E	EA-4404-CE	30A	NEMA L6-30P	(24) C13	5 kW		2U
EA-4412-C	EA-4412-E	EA-4412-CE	30A	NEMA L6-30P	(18) C13 + (6) C19	5 kW		2U
EA-44A1-C	EA-44A1-E	EA-44A1-CE	30A	NEMA L6-30P	(6) C13 + (12) C19	5 kW		2U
120/208 Volt, Single-Phase Input								
EA-4492-C	EA-4492-E	EA-4492-CE	30A	NEMA L14-30P	(12) C13 + (6) C19 + (4) 5-20	5 kW		2U
120/208 Volt, Three-Phase Input								
EA-4406-C	EA-4406-E	EA-4406-CE	20A	NEMA L21-20P	(24) C13	5.7 kW		2U
EA-4414-C	EA-4414-E	EA-4414-CE	20A	NEMA L21-20P	(18) C13 + (6) C19	5.7 kW		2U
EA-44A3-C	EA-44A3-E	EA-44A3-CE	20A	NEMA L21-20P	(6) C13 + (12) C19	5.7 kW		2U
EA-4490-C	EA-4490-E	EA-4490-CE	20A	NEMA L21-20P	(12) C13 + (6) C19 + (4) 5-20	5.7 kW		2U
EA-4407-C	EA-4407-E	EA-4407-CE	30A	NEMA L21-30P	(24) C13	8.6 kW		2U
EA-4415-C	EA-4415-E	EA-4415-CE	30A	NEMA L21-30P	(18) C13 + (6) C19	8.6 kW		2U
EA-44A5-C	EA-44A5-E	EA-44A5-CE	30A	NEMA L21-30P	(6) C13 + (12) C19	8.6 kW		2U
EA-4491-C	EA-4491-E	EA-4491-CE	30A	NEMA L21-30P	(12) C13 + (6) C19 + (4) 5-20	8.6 kW		2U
208 Volt, Three-Phase Input								
EA-4405-C	EA-4405-E	EA-4405-CE	30A	NEMA L15-30P	(24) C13	8.6 kW		2U
EA-4413-C	EA-4413-E	EA-4413-CE	30A	NEMA L15-30P	(18) C13 + (6) C19	8.6 kW		2U
EA-44A6-C	EA-44A6-E	EA-44A6-CE	30A	NEMA L15-30P	(6) C13 + (12) C19	8.6 kW		2U
EA-44A7-C	EA-44A7-E	EA-44A7-CE	50A	CS8365	(6) C13 + (12) C19	14.4 kW		2U
EA-44A8-C	EA-44A8-E	EA-44A8-CE	60A	IEC 60309 60A 3P+E	(6) C13 + (12) C19	17.2 kW		2U

Monitored Pro eConnect PDU, Horizontal - Worldwide								
Part Number			Input Amperage	Input Plug	Outlets	kW Capacity (CE)	kW Capacity North America (UL)	Form Factor (U) Height
Black*	Glacier White*	Redundancy Pack**						
220 - 240 Volt, Single-Phase Input								
EA-4408-C	EA-4408-E	EA-4408-CE	16A	C20 Inlet to IEC 60309 16A 1P+N+E	(24) C13	3.8 kW	3.8 kW	2U
EA-4419-C	EA-4419-E	EA-4419-CE	16A	C20 Inlet to IEC 60309 16A 1P+N+E	(18) C13 + (6) C19	3.8 kW	3.8 kW	2U
EA-4409-C	EA-4409-E	EA-4409-CE	32A	IEC 60309 32A 1P+N+E	(24) C13	7.7 kW	6.1 kW	2U
EA-4420-C	EA-4420-E	EA-4420-CE	32A	IEC 60309 32A 1P+N+E	(18) C13 + (6) C19	7.7 kW	6.1 kW	2U
EA-44A2-C	EA-44A2-E	EA-44A2-CE	32A	IEC 60309 32A 1P+N+E	(6) C13 + (12) C19	7.7 kW	6.1 kW	2U
220 - 240/380-415 Volt, Three-Phase Input								
EA-4410-C	EA-4410-E	EA-4410-CE	16/20A	IEC 60309 16/20A 3P+N+E	(24) C13	11.5 kW	11.5 kW	2U
EA-4421-C	EA-4421-E	EA-4421-CE	16/20A	IEC 60309 16/20A 3P+N+E	(18) C13 + (6) C19	11.5 kW	11.5 kW	2U
EA-44A4-C	EA-44A4-E	EA-44A4-CE	16/20A	IEC 60309 16/20A 3P+N+E	(6) C13 + (12) C19	11.5 kW	11.5 kW	2U
EA-44A9-C	EA-44A9-E	EA-44A9-CE	32A	IEC 60309 32A 3P+N+E	(6) C13 + (12) C19	23 kW	18.4 kW	2U

Notes: *Shipping weight for each unit is 23 lb (10.4 kg). **Redundancy Pack includes 2 PDUs in Black and Glacier White for easy identification of the primary and secondary unit; shipping weight is 45 lb (20.4 kg)



Switched eConnect PDUs provide remote monitoring of power at the rack level and individual outlet control, making it possible to remotely turn power on or off at each outlet.

Reduced Networking Costs and Complexity

Secure Array® allows the use of a single IP address for up to 48 connected PDUs (32 when electronic locks are integrated). Second IP address for the entire array provides failover capability

Simplified Load Balancing

Phase-balance outlets on three-phase models ensure equal loading across all phases; allows use of shorter equipment power cords for better cable and airflow management

No Accidental Disconnections

Patented, low-profile locking outlets prevent accidental disconnections without requiring special cords

Electronic Lock Integration

Patented technology seamlessly integrates PDU, environmental sensors and electronic locks into a single hardware and software solution

Gigabit Ethernet

Ensures compatibility with enterprise routers and switches

Cabinet Preinstallation

Complete ecosystem ships ready for IT equipment integration. Saves deployment time and reduces packaging waste.

Switched eConnect PDU

Additional Features:

- PDU monitoring and individual outlet switching; outlet grouping
- Field-replaceable controller module for easy serviceability and upgradeability while maintaining power to critical loads; SD-card transfers PDU configuration
- Bistable latching relays for reduced energy consumption and increased service reliability; maintains last state of power outlet if power is interrupted
- Input and branch circuit monitoring with billing-grade +/-1% accuracy
- Onboard GUI, RESTful API, SNMP v1/v2/v3, Command Line Interface (CLI), and native Power IQ® DCIM software integration allows users to easily manage PDUs
- Zero Touch Provisioning (ZTP) automates configuration and provisioning of large deployments of PDUs.
- HTTPs support, RADIUS and LDAP integration for enhanced authentication and security
- Customization capabilities: outlet configurations, color options, power cord length, input connection types and more
- Made in the United States, TAA-compliant

Specifications:

- Single-input, vertical rack-mount PDUs
- Circuit Protection:
 - UL 489 listed, single- or two-pole, hydraulic-magnetic breakers available on single- and three-phase models with 30A and above input
 - 10kAIC breakers on 220-240/380-415 VAC models; 5kAIC for all other models
 - Low-profile design prevents accidental discharge
- Metering:
 - Input line currents
 - Voltage, current, power, energy and power factor at branch circuits
 - +/- 1% billing-grade
 - Ability to name outlets to identify attached equipment
 - Outlet grouping for power charge back reports
- Switching:
 - Ability to turn on/off and cycle power to individual or group of outlets using bistable latching relays
 - Ability to name individual outlets to identify attached equipment
 - Status indicator LED light for individual outlets
- Console Access:
 - Through serial console port connection and Command Line Interface (CLI)
- Controller:
 - Field-replaceable module; SD-card transfers PDU configuration
- Firmware:
 - Flash upgradeable through USB port, Web interface, CLI, API or Power IQ
- Electronic Lock Integration:
 - Front and rear cabinet door locks (ordered separately) connected to AUX ports on the PDU
 - Door locks are powered from and remotely accessed through the PDU
- Mounting:
 - Vertical PDUs: 2 preinstalled tool-less mounting buttons; adjustable positions
 - Top or bottom power cord entry orientation
- Dimensions:
 - For specific dimensions, download the individual product cut sheets by searching the base part number (ex: Ex-xxxx) on chatsworth.com

Certifications:

- UL/cUL/IEC62368, CE (EU), FCC Part 15, Class A, EN 55022, RoHS Compliant

Switched eConnect PDU, Vertical - North America							
Black*	Part Number		Input Amperage	Input Plug	Outlets	kW Capacity (UL)	Cabinet Capability
	Glacier White*	Redundancy Pack**					
120 Volt, Single-Phase Input							
EA-5001-C	EA-5001-E	EA-5001-CE	20A	C20 Inlet to L5-20	(24) 5-20	1.9 kW	42U & higher
EA-5002-C	EA-5002-E	EA-5002-CE	30A	L5-30	(24) 5-20	2.9 kW	42U & higher
208 Volt, Single-Phase Input							
EA-5069-C	EA-5069-E	EA-5069-CE	20A	C20 Inlet to L6-20	(18) C13 + (6) C19	3.3 kW	42U & higher
EA-5070-C	EA-5070-E	EA-5070-CE	20A	C20 Inlet to L6-20	(24) C13	3.3 kW	42U & higher
EA-5004-C	EA-5004-E	EA-5004-CE	30A	L6-30	(24) C13	5 kW	42U & higher
EA-5012-C	EA-5012-E	EA-5012-CE	30A	L6-30	(18) C13 + (6) C19	5 kW	42U & higher
120/208 Volt, Three-Phase Input							
EA-5006-C	EA-5006-E	EA-5006-CE	20A	L21-20	(24) C13	5.7 kW	42U & higher
EA-5014-C	EA-5014-E	EA-5014-CE	20A	L21-20	(18) C13 + (6) C19	5.7 kW	42U & higher
EA-5025-C	EA-5025-E	EA-5025-CE	20A	L21-20	(18) C13 + (6) C19 Outlets + (3) 5-20 Convenience Outlets***	5.7 kW	42U & higher
EA-5007-C	EA-5007-E	EA-5007-CE	30A	L21-30	(24) C13	8.6 kW	42U & higher
EA-5015-C	EA-5015-E	EA-5015-CE	30A	L21-30	(18) C13 + (6) C19	8.6 kW	42U & higher
EA-5026-C	EA-5026-E	EA-5026-CE	30A	L21-30	(18) C13 + (6) C19 Outlets + (3) 5-20 Convenience Outlets***	8.6 kW	42U & higher
EA-5035-C	EA-5035-E	EA-5035-CE	30A	L21-30	(36) C13	8.6 kW	42U & higher
208 Volt, Three-Phase Input							
EA-5005-C	EA-5005-E	EA-5005-CE	30A	L15-30	(24) C13	8.6 kW	42U & higher
EA-5013-C	EA-5013-E	EA-5013-CE	30A	L15-30	(18) C13 + (6) C19	8.6 kW	42U & higher
EA-5034-C	EA-5034-E	EA-5034-CE	30A	L15-30	(36) C13	8.6 kW	42U & higher
EA-5016-C	EA-5016-E	EA-5016-CE	50A	CS8365	(18) C13 + (6) C19	14.4 kW	42U & higher
EA-5027-C	EA-5027-E	EA-5027-CE	50A	CS8365	(12) C13 + (12) C19	14.4 kW	42U & higher
EA-5136-C	EA-5136-E	EA-5136-CE	50A	CS8365	(36) C13	14.4 kW	45U & higher
EA-5144-C	EA-5144-E	EA-5144-CE	50A	CS8365	(24) C13 + (12) C19	14.4 kW	45U & higher
EA-5017-C	EA-5017-E	EA-5017-CE	60A	IEC 60309 60A 3P+E	(18) C13 + (6) C19	17.2 kW	42U & higher
EA-5028-C	EA-5028-E	EA-5028-CE	60A	IEC 60309 60A 3P+E	(12) C13 + (12) C19	17.2 kW	42U & higher
EA-5137-C	EA-5137-E	EA-5137-CE	60A	IEC 60309 60A 3P+E	(36) C13	17.2 kW	45U & higher
EA-5145-C	EA-5145-E	EA-5145-CE	60A	IEC 60309 60A 3P+E	(24) C13 + (12) C19	17.2 kW	45U & higher
240/415 Volt, Three-Phase Input							
EA-5018-C	EA-5018-E	EA-5018-CE	30A	L22-30	(18) C13 + (6) C19	17.2 kW	42U & higher
EA-5029-C	EA-5029-E	EA-5029-CE	30A	L22-30	(12) C13 + (12) C19	17.2 kW	42U & higher
EA-5038-C	EA-5038-E	EA-5038-CE	30A	L22-30	(36) C13	17.2 kW	42U & higher
EA-5046-C	EA-5046-E	EA-5046-CE	30A	L22-30	(24) C13 + (12) C19	17.2 kW	42U & higher

Notes: *Shipping weight for each unit is 27 lb (12 kg).

**Redundancy Pack includes 2 PDUs in Black and Glacier White for easy identification of the primary and secondary unit; shipping weight is 54 lb (24 kg).

***Convenience outlets do not provide monitoring or switching capabilities.

SWITCHED ECONNECT® PDU, VERTICAL

Switched eConnect PDU, Vertical - Worldwide								
Part Number			Input Amperage	Input Plug	Outlets	kW Capacity Worldwide (CE)	kW Capacity North America (UL)	Cabinet Capability
Black*	Glacier White*	Redundancy Pack**						
220 - 240 Volt, Single-Phase Input								
EA-5008-C	EA-5008-E	EA-5008-CE	16A	C20 Inlet to IEC 60309 16A 1P+N+E	(24) C13	3.8 kW	3.8 kW	42U & higher
EA-5019-C	EA-5019-E	EA-5019-CE	16A	C20 Inlet to IEC 60309 16A 1P+N+E	(18) C13 + (6) C19	3.8 kW	3.8 kW	42U & higher
EA-5009-C	EA-5009-E	EA-5009-CE	32A	IEC 60309 32A 1P+N+E	(24) C13	7.7 kW	6.1 kW	42U & higher
EA-5020-C	EA-5020-E	EA-5020-CE	32A	IEC 60309 32A 1P+N+E	(18) C13 + (6) C19	7.7 kW	6.1 kW	42U & higher
220-240/380-415 Volt, Three-Phase Input								
EA-5010-C	EA-5010-E	EA-5010-CE	16/20A	IEC 60309 16/20A 3P+N+E	(24) C13	11.5 kW	11.5 kW	42U & higher
EA-5021-C	EA-5021-E	EA-5021-CE	16/20A	IEC 60309 16/20A 3P+N+E	(18) C13 + (6) C19	11.5 kW	11.5 kW	42U & higher
EA-5030-C	EA-5030-E	EA-5030-CE	16/20A	IEC 60309 16/20A 3P+N+E	(12) C13 + (12) C19	11.5 kW	11.5 kW	42U & higher
EA-5039-C	EA-5039-E	EA-5039-CE	16/20A	IEC 60309 16/20A 3P+N+E	(36) C13	11.5 kW	11.5 kW	42U & higher
EA-5047-C	EA-5047-E	EA-5047-CE	16/20A	IEC 60309 16/20A 3P+N+E	(24) C13 + (12) C19	11.5 kW	11.5 kW	42U & higher
EA-5022-C	EA-5022-E	EA-5022-CE	32A	IEC 60309 32A 3P+N+E	(18) C13 + (6) C19	23 kW	18.4 kW	42U & higher
EA-5031-C	EA-5031-E	EA-5031-CE	32A	IEC 60309 32A 3P+N+E	(12) C13 + (12) C19	23 kW	18.4 kW	42U & higher
EA-5040-C	EA-5040-E	EA-5040-CE	32A	IEC 60309 32A 3P+N+E	(36) C13	23 kW	18.4 kW	42U & higher
EA-5048-C	EA-5048-E	EA-5048-CE	32A	IEC 60309 32A 3P+N+E	(24) C13 + (12) C19	23 kW	18.4 kW	42U & higher

Notes: *Shipping weight for each unit is 27 lb (12 kg). **Redundancy Pack includes 2 PDUs (one in Black and one in Glacier White) for easy identification of the primary and secondary unit; shipping weight is 54 lb (24 kg).



The Power Selector enables you to select the best power product for your application by narrowing down options based on your requirements. After you're done comparing, you can email or print the results. Visit selectapdu.com to access the Power Selector.



Vertical and Horizontal Options Available



Switched Pro eConnect PDUs provide remote power monitoring and control for each outlet on the PDU, making it possible to remotely measure and cycle power for each piece of equipment attached to the PDU.

Reduced Networking Costs and Complexity

Secure Array® allows the use of a single IP address for up to 48 connected PDUs (32 when electronic locks are integrated). Second IP address for the entire array provides failover capability

Simplified Load Balancing

Phase-balance outlets on three-phase models ensure equal loading across all phases; allows use of shorter equipment power cords for better cable and airflow management

No Accidental Disconnections

Patented, low-profile locking outlets prevent accidental disconnections without requiring special cords

Electronic Lock Integration

Patented technology seamlessly integrates PDU, environmental sensors and electronic locks into a single hardware and software solution

Gigabit Ethernet

Ensures compatibility with enterprise routers and switches

Cabinet Preinstallation

Complete ecosystem ships ready for IT equipment integration. Saves deployment time and reduces packaging waste.

Switched Pro eConnect PDU

Additional Features:

- Individual outlet monitoring and switching; outlet grouping
- Field-replaceable controller module for easy serviceability and upgradeability while maintaining power to critical loads; SD-card transfers PDU configuration
- Bistable latching relays for reduced energy consumption and increased service reliability; maintains last state of power outlet if power is interrupted
- Input and branch circuit monitoring with billing-grade +/-1% accuracy
- Onboard GUI, RESTful API, SNMP v1/v2/v3, Command Line Interface (CLI) and native Power IQ® DCIM software integration allows users to easily manage PDUs
- Zero Touch Provisioning (ZTP) automates configuration and provisioning of large deployments of PDUs.
- HTTPs support, RADIUS and LDAP integration for enhanced authentication and security
- Customization capabilities: outlet configurations, color options, power cord length, input connection types and more
- Made in the United States, TAA-compliant

Specifications:

- Single-input, vertical and horizontal rack-mount PDUs
- Circuit Protection:
 - UL 489 listed, single- or two-pole, hydraulic-magnetic breakers available on single- and three-phase models with 30A and above input
 - 10kAIC breakers on 220-240/380-415 VAC models; 5kAIC for all other models
 - Low-profile design prevents accidental discharge
- Metering:
 - Input line currents
 - Voltage, current, power, energy and power factor at branch circuits and individual outlets
 - +/- 1% billing-grade
 - Ability to name outlets to identify attached equipment
 - Outlet grouping for power charge back reports
- Switching:
 - Ability to turn on/off and cycle power to individual or group of outlets using bistable latching relays
 - Ability to name individual outlets to identify attached equipment
 - Status indicator LED light for individual outlets
 - Grouping of outlets for consolidated power control
- Console Access:
 - Through serial console port connection and Command Line Interface (CLI)
- Controller:
 - Field-replaceable module; SD-card transfers PDU configuration
- Firmware:
 - Flash upgradeable through USB port, Web interface, CLI, API or Power IQ
- Electronic Lock Integration:
 - Front and rear cabinet door locks (ordered separately) connected to ports on PDU
 - Door locks are powered from and remotely accessed through the PDU
- Mounting:
 - Vertical PDUs: 2 preinstalled tool-less mounting buttons; adjustable positions; Top or bottom power cord entry orientation
- Dimensions:
 - For specific dimensions, download the individual product cut sheets by searching the base part number (ex: Ex-xxxx) on chatsworth.com

Certifications:

- UL/cUL/IEC62368, CE (EU), FCC Part 15, Class A, EN 55022, RoHS Compliant

SWITCHED PRO ECONNECT® PDU, VERTICAL

Switched Pro eConnect PDU, Vertical - North America							
Part Number			Input Amperage	Input Plug	Outlets	kW Capacity (UL)	Cabinet Capacity
Black*	Glacier White*	Redundancy Pack**					
120 Volt, Single-Phase Input							
EA-6001-C	EA-6001-E	EA-6001-CE	20A	C20 Inlet to L5-20	(24) 5-20	1.9 kW	42U & higher
EA-6002-C	EA-6002-E	EA-6002-CE	30A	L5-30	(24) 5-20	2.9 kW	42U & higher
208 Volt, Single-Phase Input							
EA-6069-C	EA-6069-E	EA-6069-CE	20A	C20 Inlet to L6-20	(18) C13 + (6) C19	3.3 kW	42U & higher
EA-6070-C	EA-6070-E	EA-6070-CE	20A	C20 Inlet to L6-20	(24) C13	3.3 kW	42U & higher
EA-6004-C	EA-6004-E	EA-6004-CE	30A	L6-30	(24) C13	5 kW	42U & higher
EA-6012-C	EA-6012-E	EA-6012-CE	30A	L6-30	(18) C13 + (6) C19	5 kW	42U & higher
120/208 Volt, Three-Phase Input							
EA-6006-C	EA-6006-E	EA-6006-CE	20A	L21-20	(24) C13	5.7 kW	42U & higher
EA-6014-C	EA-6014-E	EA-6014-CE	20A	L21-20	(18) C13 + (6) C19	5.7 kW	42U & higher
EA-6025-C	EA-6025-E	EA-6025-CE	20A	L21-20	(18) C13 + (6) C19 Outlets + (3) 5-20 Convenience Outlets***	5.7 kW	42U & higher
EA-6007-C	EA-6007-E	EA-6007-CE	30A	L21-30	(24) C13	8.6 kW	42U & higher
EA-6015-C	EA-6015-E	EA-6015-CE	30A	L21-30	(18) C13 + (6) C19	8.6 kW	42U & higher
EA-6026-C	EA-6026-E	EA-6026-CE	30A	L21-30	(18) C13 + (6) C19 Outlets + (3) 5-20 Convenience Outlets***	8.6 kW	42U & higher
EA-6035-C	EA-6035-E	EA-6035-CE	30A	L21-30	(36) C13	8.6 kW	42U & higher
208 Volt, Three-Phase Input							
EA-6005-C	EA-6005-E	EA-6005-CE	30A	L15-30	(24) C13	8.6 kW	42U & higher
EA-6013-C	EA-6013-E	EA-6013-CE	30A	L15-30	(18) C13 + (6) C19	8.6 kW	42U & higher
EA-6034-C	EA-6034-E	EA-6034-CE	30A	L15-30	(36) C13	8.6 kW	42U & higher
EA-6016-C	EA-6016-E	EA-6016-CE	50A	CS8365	(18) C13 + (6) C19	14.4 kW	42U & higher
EA-6027-C	EA-6027-E	EA-6027-CE	50A	CS8365	(12) C13 + (12) C19	14.4 kW	42U & higher
EA-6136-C	EA-6136-E	EA-6136-CE	50A	CS8365	(36) C13	14.4 kW	45U & higher
EA-6144-C	EA-6144-E	EA-6144-CE	50A	CS8365	(24) C13 + (12) C19	14.4 kW	45U & higher
EA-6017-C	EA-6017-E	EA-6017-CE	60A	IEC 60309 60A 3P+E	(18) C13 + (6) C19	17.2 kW	42U & higher
EA-6028-C	EA-6028-E	EA-6028-CE	60A	IEC 60309 60A 3P+E	(12) C13 + (12) C19	17.2 kW	42U & higher
EA-6137-C	EA-6137-E	EA-6137-CE	60A	IEC 60309 60A 3P+E	(36) C13	17.2 kW	45U & higher
EA-6145-C	EA-6145-E	EA-6145-CE	60A	IEC 60309 60A 3P+E	(24) C13 + (12) C19	17.2 kW	45U & higher
240/415 Volt, Three-Phase Input							
EA-6018-C	EA-6018-E	EA-6018-CE	30A	L22-30	(18) C13 + (6) C19	17.2 kW	42U & higher
EA-6029-C	EA-6029-E	EA-6029-CE	30A	L22-30	(12) C13 + (12) C19	17.2 kW	42U & higher
EA-6038-C	EA-6038-E	EA-6038-CE	30A	L22-30	(36) C13	17.2 kW	42U & higher
EA-6046-C	EA-6046-E	EA-6046-CE	30A	L22-30	(24) C13 + (12) C19	17.2 kW	42U & higher

Notes: *Shipping weight for each unit is 27 lb (12 kg).

**Redundancy Pack includes 2 PDUs in Black and Glacier White for easy identification of the primary and secondary unit; shipping weight is 54 lb (24 kg).

***Convenience outlets do not provide monitoring or switching capabilities.



The Power Selector enables you to select the best power product for your application by narrowing down options based on your requirements. After you're done comparing, you can email or print the results. Visit selectapdu.com to access the Power Selector.

Switched Pro eConnect PDU, Vertical - Worldwide								
Part Number			Input Amperage	Input Plug	Outlets	kW Capacity Worldwide (CE)	kW Capacity North America (UL)	Cabinet Capability
Black*	Glacier White*	Redundancy Pack**						
220 - 240 Volt, Single-Phase Input								
EA-6008-C	EA-6008-E	EA-6008-CE	16/20A	C20 Inlet to IEC 60309 16/20A 1P+N+E	(24) C13	3.8 kW	3.8 kW	42U & higher
EA-6019-C	EA-6019-E	EA-6019-CE	16/20A	C20 Inlet to IEC 60309 16/20A 1P+N+E	(18) C13 + (6) C19	3.8 kW	3.8 kW	42U & higher
EA-6009-C	EA-6009-E	EA-6009-CE	32A	IEC 60309 32A 1P+N+E	(24) C13	7.7 kW	6.1 kW	42U & higher
EA-6020-C	EA-6020-E	EA-6020-CE	32A	IEC 60309 32A 1P+N+E	(18) C13 + (6) C19	7.7 kW	6.1 kW	42U & higher
220-240/380-415 Volt, Three-Phase Input								
EA-6010-C	EA-6010-E	EA-6010-CE	16/20A	IEC 60309 16/20A 3P+N+E	(24) C13	11.5 kW	11.5 kW	42U & higher
EA-6021-C	EA-6021-E	EA-6021-CE	16/20A	IEC 60309 16/20A 3P+N+E	(18) C13 + (6) C19	11.5 kW	11.5 kW	42U & higher
EA-6030-C	EA-6030-E	EA-6030-CE	16/20A	IEC 60309 16/20A 3P+N+E	(12) C13 + (12) C19	11.5 kW	11.5 kW	42U & higher
EA-6039-C	EA-6039-E	EA-6039-CE	16/20A	IEC 60309 16/20A 3P+N+E	(36) C13	11.5 kW	11.5 kW	42U & higher
EA-6047-C	EA-6047-E	EA-6047-CE	16/20A	IEC 60309 16/20A 3P+N+E	(24) C13 + (12) C19	11.5 kW	11.5 kW	42U & higher
EA-6022-C	EA-6022-E	EA-6022-CE	32A	IEC 60309 32A 3P+N+E	(18) C13 + (6) C19	23 kW	18.4 kW	42U & higher
EA-6031-C	EA-6031-E	EA-6031-CE	32A	IEC 60309 32A 3P+N+E	(12) C13 + (12) C19	23 kW	18.4 kW	42U & higher
EA-6040-C	EA-6040-E	EA-6040-CE	32A	IEC 60309 32A 3P+N+E	(36) C13	23 kW	18.4 kW	42U & higher
EA-6048-C	EA-6048-E	EA-6048-CE	32A	IEC 60309 32A 3P+N+E	(24) C13 + (12) C19	23 kW	18.4 kW	42U & higher

Notes: *Shipping weight for each unit is 27 lb (12 kg).

**Redundancy Pack includes 2 PDUs (one in Black and one in Glacier White) for easy identification of the primary and secondary unit; shipping weight is 54 lb (24 kg).



The Power Selector enables you to select the best power product for your application by narrowing down options based on your requirements. After you're done comparing, you can email or print the results. Visit selectapdu.com to access the Power Selector.

SWITCHED PRO ECONNECT® PDU, HORIZONTAL

Switched Pro eConnect PDU, Horizontal - North America								
Part Number			Input Amperage	Input Plug	Outlets	kW Capacity (UL)	Form Factor (U) Height	
Black*	Glacier White*	Redundancy Pack**						
120 Volt, Single-Phase Input								
EA-6274-C	EA-6274-E	EA-6274-CE	20A	C20 Inlet to L5-20	(12) 5-20	1.9 kW	1U	
EA-6275-C	EA-6275-E	EA-6275-CE	30A	NEMA L5-30P	(12) 5-20	2.9 kW	1U	
208 Volt, Single-Phase Input								
EA-6276-C	EA-6276-E	EA-6276-CE	20A	C20 Inlet to L6-20	(12) C13	3.3 kW	1U	
EA-6293-C	EA-6293-E	EA-6293-CE	20A	C20 Inlet to L6-20	(8) C13 + (4) C19	3.3 kW	1U	
EA-6277-C	EA-6277-E	EA-6277-CE	30A	NEMA L6-30P	(12) C13	5 kW	1U	
EA-6284-C	EA-6284-E	EA-6284-CE	30A	NEMA L6-30P	(9) C19	5 kW	1U	
EA-6294-C	EA-6294-E	EA-6294-CE	30A	NEMA L6-30P	(8) C13 + (4) C19	5 kW	1U	
120/208 Volt, Three-Phase Input								
EA-6279-C	EA-6279-E	EA-6279-CE	20A	NEMA L21-20P	(12) C13	5.7 kW	1U	
EA-6286-C	EA-6286-E	EA-6286-CE	20A	NEMA L21-20P	(9) C19	5.7 kW	1U	
EA-6296-C	EA-6296-E	EA-6296-CE	20A	NEMA L21-20P	(8) C13 + (4) C19	5.7 kW	1U	
EA-6280-C	EA-6280-E	EA-6280-CE	30A	NEMA L21-30P	(12) C13	8.6 kW	1U	
EA-6287-C	EA-6287-E	EA-6287-CE	30A	NEMA L21-30P	(9) C19	8.6 kW	1U	
EA-6297-C	EA-6297-E	EA-6297-CE	30A	NEMA L21-30P	(8) C13 + (4) C19	8.6 kW	1U	
208 Volt, Three-Phase Input								
EA-6278-C	EA-6278-E	EA-6278-CE	30A	NEMA L15-30P	(12) C13	8.6 kW	1U	
EA-6285-C	EA-6285-E	EA-6285-CE	30A	NEMA L15-30P	(9) C19	8.6 kW	1U	
EA-6295-C	EA-6295-E	EA-6295-CE	30A	NEMA L15-30P	(8) C13 + (4) C19	8.6 kW	1U	

Switched Pro eConnect PDU, Horizontal - Worldwide									
Part Number			Input Amperage	Input Plug	Outlets	kW Capacity (CE)	kW Capacity North America (UL)	Form Factor (U) Height	
Black*	Glacier White*	Redundancy Pack**							
220 - 240 Volt, Single-Phase Input									
EA-6281-C	EA-6281-E	EA-6281-CE	16A	C20 Inlet to IEC 60309 16A 1P+N+E	(12) C13	3.8 kW	3.8 kW	1U	
EA-6298-C	EA-6298-E	EA-6298-CE	16A	C20 Inlet to IEC 60309 16A 1P+N+E	(8) C13 + (4) C19	3.8 kW	3.8 kW	1U	
EA-6283-C	EA-6283-E	EA-6283-CE	32A	IEC 60309 32A 1P+N+E	(12) C13	7.7 kW	6.1 kW	1U	
EA-6289-C	EA-6289-E	EA-6289-CE	32A	IEC 60309 32A 1P+N+E	(9) C19	7.7 kW	6.1 kW	1U	
EA-62A0-C	EA-62A0-E	EA-62A0-CE	32A	IEC 60309 32A 1P+N+E	(8) C13 + (4) C19	7.7 kW	6.1 kW	1U	
220 - 240/380-415 Volt, Three-Phase Input									
EA-6282-C	EA-6282-E	EA-6282-CE	16/20A	IEC 60309 16/20A 3P+N+E	(12) C13	11.5 kW	11.5 kW	1U	
EA-6288-C	EA-6288-E	EA-6288-CE	16/20A	IEC 60309 16/20A 3P+N+E	(9) C19	11.5 kW	11.5 kW	1U	
EA-6299-C	EA-6299-E	EA-6299-CE	16/20A	IEC 60309 16/20A 3P+N+E	(8) C13 + (4) C19	11.5 kW	11.5 kW	1U	

Notes: *Shipping weight for each unit is 18 lb (8.2 kg). **Redundancy Pack includes 2 PDUs in Black and Glacier White for easy identification of the primary and secondary unit; shipping weight is 35 lb (15.9 kg)

SWITCHED PRO ECONNECT® PDU, HORIZONTAL

Switched Pro eConnect PDU, Horizontal - North America								
Part Number			Input Amperage	Input Plug	Outlets	kW Capacity (UL)	Form Factor (U) Height	
Black*	Glacier White*	Redundancy Pack**						
120 Volt, Single-Phase Input								
EA-6401-C	EA-6401-E	EA-6401-CE	20A	C20 Inlet to L5-20	(24) 5-20	1.9 kW		2U
EA-6402-C	EA-6402-E	EA-6402-CE	30A	NEMA L5-30P	(24) 5-20	2.9 kW		2U
208 Volt, Single-Phase Input								
EA-6470-C	EA-6470-E	EA-6470-CE	20A	C20 Inlet to L6-20	(24) C13	3.3 kW		2U
EA-6469-C	EA-6469-E	EA-6469-CE	20A	C20 Inlet to L6-20	(18) C13 + (6) C19	3.3 kW		2U
EA-6404-C	EA-6404-E	EA-6404-CE	30A	NEMA L6-30P	(24) C13	5 kW		2U
EA-6412-C	EA-6412-E	EA-6412-CE	30A	NEMA L6-30P	(18) C13 + (6) C19	5 kW		2U
EA-64A1-C	EA-64A1-E	EA-64A1-CE	30A	NEMA L6-30P	(6) C13 + (12) C19	5 kW		2U
120/208 Volt, Single-Phase Input								
EA-6492-C	EA-6492-E	EA-6492-CE	30A	NEMA L14-30P	(12) C13 + (6) C19 + (4) 5-20	5 kW		2U
120/208 Volt, Three-Phase Input								
EA-6406-C	EA-6406-E	EA-6406-CE	20A	NEMA L21-20P	(24) C13	5.7 kW		2U
EA-6414-C	EA-6414-E	EA-6414-CE	20A	NEMA L21-20P	(18) C13 + (6) C19	5.7 kW		2U
EA-64A3-C	EA-64A3-E	EA-64A3-CE	20A	NEMA L21-20P	(6) C13 + (12) C19	5.7 kW		2U
EA-6490-C	EA-6490-E	EA-6490-CE	20A	NEMA L21-20P	(12) C13 + (6) C19 + (4) 5-20	5.7 kW		2U
EA-6407-C	EA-6407-E	EA-6407-CE	30A	NEMA L21-30P	(24) C13	8.6 kW		2U
EA-6415-C	EA-6415-E	EA-6415-CE	30A	NEMA L21-30P	(18) C13 + (6) C19	8.6 kW		2U
EA-64A5-C	EA-64A5-E	EA-64A5-CE	30A	NEMA L21-30P	(6) C13 + (12) C19	8.6 kW		2U
EA-6491-C	EA-6491-E	EA-6491-CE	30A	NEMA L21-30P	(12) C13 + (6) C19 + (4) 5-20	8.6 kW		2U
208 Volt, Three-Phase Input								
EA-6405-C	EA-6405-E	EA-6405-CE	30A	NEMA L15-30P	(24) C13	8.6 kW		2U
EA-6413-C	EA-6413-E	EA-6413-CE	30A	NEMA L15-30P	(18) C13 + (6) C19	8.6 kW		2U
EA-64A6-C	EA-64A6-E	EA-64A6-CE	30A	NEMA L15-30P	(6) C13 + (12) C19	8.6 kW		2U
EA-64A7-C	EA-64A7-E	EA-64A7-CE	50A	CS8365	(6) C13 + (12) C19	14.4 kW		2U
EA-64A8-C	EA-64A8-E	EA-64A8-CE	60A	IEC 60309 60A 3P+E	(6) C13 + (12) C19	17.2 kW		2U

Switched Pro eConnect PDU, Horizontal - Worldwide									
Part Number			Input Amperage	Input Plug	Outlets	kW Capacity (CE)	kW Capacity North America (UL)	Form Factor (U) Height	
Black*	Glacier White*	Redundancy Pack**							
220 - 240 Volt, Single-Phase Input									
EA-6408-C	EA-6408-E	EA-6408-CE	16A	C20 Inlet to IEC 60309 16A 1P+N+E	(24) C13	3.8 kW	3.8 kW	2U	
EA-6419-C	EA-6419-E	EA-6419-CE	16A	C20 Inlet to IEC 60309 16A 1P+N+E	(18) C13 + (6) C19	3.8 kW	3.8 kW	2U	
EA-6409-C	EA-6409-E	EA-6409-CE	32A	IEC 60309 32A 1P+N+E	(24) C13	7.7 kW	6.1 kW	2U	
EA-6420-C	EA-6420-E	EA-6420-CE	32A	IEC 60309 32A 1P+N+E	(18) C13 + (6) C19	7.7 kW	6.1 kW	2U	
EA-64A2-C	EA-64A2-E	EA-64A2-CE	32A	IEC 60309 32A 1P+N+E	(6) C13 + (12) C19	7.7 kW	6.1 kW	2U	
220 - 240/380-415 Volt, Three-Phase Input									
EA-6410-C	EA-6410-E	EA-6410-CE	16/20A	IEC 60309 16/20A 3P+N+E	(24) C13	11.5 kW	11.5 kW	2U	
EA-6421-C	EA-6421-E	EA-6421-CE	16/20A	IEC 60309 16/20A 3P+N+E	(18) C13 + (6) C19	11.5 kW	11.5 kW	2U	
EA-64A4-C	EA-64A4-E	EA-64A4-CE	16/20A	IEC 60309 16/20A 3P+N+E	(6) C13 + (12) C19	11.5 kW	11.5 kW	2U	
EA-64A9-C	EA-64A9-E	EA-64A9-CE	32A	IEC 60309 32A 3P+N+E	(6) C13 + (12) C19	23 kW	18.4 kW	2U	

Notes: *Shipping weight for each unit is 23 lb (10.4 kg). **Redundancy Pack includes 2 PDUs in Black and Glacier White for easy identification of the primary and secondary unit; shipping weight is 45 lb (20.4 kg)



14676-001



14812-001

Field-Replaceable Controller Module

Field-replaceable controller module for eConnect® Power Distribution Unit (PDU). Compatible with eConnect Monitored, Monitored Pro, Switched or Switched Pro eConnect PDUs. Allows replacement of controller module while maintaining power to critical loads. Ability to use an SD-card to transfer PDU configuration. Available in two options, to match to either a Vertical or Horizontal eConnect PDU form factor. Both controller modules include connections for ethernet, Secure Array IP Consolidation, temperature and humidity sensors, RFID Electronic Locks and serial/console interface. Controller module for Vertical eConnect PDUs also includes a local display.

Part Number	Description	Shipping Weight lb (kg)
14676-001	eConnect Controller 4 (MCM4) for Vertical eConnect PDUs	1 (0.5)
14812-001	eConnect Controller 4 (MCM4) for Horizontal eConnect PDUs	1 (0.5)

Note: Compatible with PDU P/Ns: EA-3xxx, EA-4xxx, EA-5xxx, EA-6xxx.



eConnect® RFID Electronic Lock Kit

Integrate cabinet access control along with power management and environmental monitoring under a single network connection, one user interface and one user database for dramatically reduced deployment savings. Fully compatible with DCIM software. Available on Monitored, Monitored Pro, Switched and Switched Pro eConnect PDUs

Part Number	Description	Shipping Weight lb (kg)
14666-001	eConnect® RFID Electronic Lock Kit For ZetaFrame	3 (1.4)



Power IQ® for eConnect PDUs

Features:

- Vendor-agnostic tool that provides monitoring, logging and charting of a variety of data center assets (health map, trend analysis, capacity forecast, power chargeback reports, and more)
- Power Usage Effectiveness (PUE) gauge and chart
- Centralized power control of all IT assets connected to Switched and Switched Pro PDUs
- Centralized grouping capabilities of outlets, PDUs and other equipment
- Automated emails alerts for quick identification of hotspots and other threshold violations
- Full support of CPI Secure Array technology, which allows you to achieve 90% reduction in rack PDU networking costs by supporting IP consolidation and failover capability
- Constant synchronization of data between eConnect PDUs and PIQ software
- Easy integration into third party applications through Web APIs
- Easy integration of SNMP enabled hardware devices through Dynamic plugins

Part Number	Power IQ for eConnect - Software and License, With One (1) Year Maintenance Plan
36603-001	Software and License for up to 10 Devices
36603-002	Software and License for up to 20 Devices
36603-005	Software and License for up to 50 Devices
36603-010	Software and License for up to 100 Devices
36603-020	Software and License for up to 200 Devices
36603-030	Software and License for up to 300 Devices
36603-040	Software and License for up to 400 Devices
36603-050	Software and License for up to 500 Devices

Part Number	Power IQ for eConnect - Support Services
36605-001	1-Hour of Professional Service
36605-002	1-Day Quick-Start Service
36605-003	Dynamic Plug-In, Developed, Certified and Tested by Professional Services

Part Number	Power IQ for eConnect - Additional Device Licenses
36604-001	Additional License for up to 10 Devices
36604-002	Additional License for up to 20 Devices
36604-005	Additional License for up to 50 Devices
36604-010	Additional License for up to 100 Devices

Part Number	Power IQ for eConnect - Server Hardware
36516-002	Power IQ for eConnect software, 39 lb (18 kg) Pre-installed on 1U Configured Dual Power Supply Server, 1 Year Support and Maintenance, Includes Rail Kit

Power Strips

Power Strips distribute basic, single-phase power to multiple pieces of equipment from a single power connection and provide optional features for local metering.

- NEMA-style outlets and plugs
- Includes a thermal circuit breaker to protect circuits from overload
- Available with surge-protection to protect equipment from power spikes and local meters to provide easy voltage and current monitoring

Part Number	Input			Output		Dims - in (mm)		
	Amp	kW	Plug	Breakers	Outlets	H	W	D
110-120 Volt, Single-Phase Power Strip								
12850-701	20	1.4	NEMA 5-15P	1 x 20A	(14) 5-20R	33.0 (838)	1.7 (43)	1.7 (43)
12848-701	15	1.4	NEMA 5-15P	2 x 10A	(24) 5-20R	66.0 (1676)	1.7 (43)	1.7 (43)
12850-703	20	1.4	NEMA L5-15P	1 x 20A	(14) 5-20R	33.0 (838)	1.7 (43)	1.7 (43)
12848-703	15	1.4	NEMA L5-15P	2 x 10A	(24) 5-20R	66.0 (1676)	1.7 (43)	1.7 (43)
12850-705	20	1.9	NEMA 5-20P	1 x 20A	(14) 5-20R	33.0 (838)	1.7 (43)	1.7 (43)
12848-705	20	1.9	NEMA 5-20P	2 x 10A	(24) 5-20R	66.0 (1676)	1.7 (43)	1.7 (43)
12850-707	20	1.9	NEMA L5-20P	1 x 20A	(14) 5-20R	33.0 (838)	1.7 (43)	1.7 (43)
12848-707	20	1.9	NEMA L5-20P	2 x 10A	(24) 5-20R	66.0 (1676)	1.7 (43)	1.7 (43)
110-120 Volt, Single-Phase Power Strip, Surge-Protected								
12850-702	15	1.4	NEMA 5-15P	1 x 20A	(14) 5-20R	33.0 (838)	1.7 (43)	1.7 (43)
12848-702	15	1.4	NEMA 5-15P	2 x 10A	(24) 5-20R	66.0 (1676)	1.7 (43)	1.7 (43)
12850-704	15	1.4	NEMA L5-15P	1 x 20A	(14) 5-20R	33.0 (838)	1.7 (43)	1.7 (43)
12848-704	15	1.4	NEMA L5-15P	2 x 10A	(24) 5-20R	66.0 (1676)	1.7 (43)	1.7 (43)
12850-706	20	1.9	NEMA 5-20P	1 x 20A	(14) 5-20R	33.0 (838)	1.7 (43)	1.7 (43)
12848-706	20	1.9	NEMA 5-20P	2 x 10A	(24) 5-20R	66.0 (1676)	1.7 (43)	1.7 (43)
12850-708	20	1.9	NEMA L5-20P	1 x 20A	(14) 5-20R	33.0 (838)	1.7 (43)	1.7 (43)
12848-708	20	1.9	NEMA L5-20P	2 x 10A	(24) 5-20R	66.0 (1676)	1.7 (43)	1.7 (43)

Notes: Input current is the breaker rating. The Input Amp column lists the maximum rated value of the Input Plug/inlet and circuit breaker rating. UL/NEC regulatory code requires current ratings on product labels to be derated to 80% of the maximum rated values (for example: 20 Amp = 16 Amp on UL product label). For the Input kW column, all values are derated calculations per UL for use in North America. Input kW is the listed rating. Includes rack mounting brackets and tool-less hardware. All power strips have IEC C20 inlets and include a power cord. Cords with locking plugs are 10' L (3 m). Cords with straight plugs are 8'2" L (2.4 m). Order mounting brackets for cabinets separately.

Metered Power Strips, Vertical Mount

Part Number	Input			Output		Dims - in (mm)		
	Amp	kW	Plug	Breakers	Outlets	H	W	D
110-120 Volt, Single-Phase Power Strip								
12848-751	15	1.4	NEMA 5-15P	2 x 10A	(24) 5-20R	66.0 (1676)	1.7 (43)	1.7 (43)
12848-755	20	1.9	NEMA 5-20P	2 x 10A	(24) 5-20R	66.0 (1676)	1.7 (43)	1.7 (43)
12848-757	20	1.9	NEMA L5-20P	2 x 10A	(24) 5-20R	66.0 (1676)	1.7 (43)	1.7 (43)
110-120 Volt, Single-Phase Power Strip, Surge-Protected								
12848-752	15	1.4	NEMA 5-15P	2 x 10A	(24) 5-20R	66.0 (1676)	1.7 (43)	1.7 (43)
12848-754	15	1.4	NEMA L5-15P	2 x 10A	(24) 5-20R	66.0 (1676)	1.7 (43)	1.7 (43)
12848-756	20	1.9	NEMA 5-20P	2 x 10A	(24) 5-20R	66.0 (1676)	1.7 (43)	1.7 (43)
12848-758	20	1.9	NEMA L5-20P	2 x 10A	(24) 5-20R	66.0 (1676)	1.7 (43)	1.7 (43)

Notes: Input current is the breaker rating. The Input Amp column lists the maximum rated value of the Input Plug/inlet and circuit breaker rating. UL/NEC regulatory code requires current ratings on product labels to be derated to 80% of the maximum rated values (for example: 20 Amp = 16 Amp on UL product label). For the Input kW column, all values are derated calculations per UL for use in North America. Input kW is the listed rating. Includes rack mounting brackets and tool-less hardware. All power strips have IEC C20 inlets and include a power cord. Cords with locking plugs are 10' L (3 m). Cords with straight plugs are 8'2" L (2.4 m). Order mounting brackets for cabinets separately.

Basic Power Strips, Horizontal Rack-Mount

Part Number	Input			Output		Dims - in (mm)		
	Amp	kW	Plug	Breakers	Outlets	H	W	D
110-120 Volt, Single-Phase Power Strip								
12816-701	15	1.4	NEMA 5-15P	1 x 20A	(8) 5-20R	1U	19"EIA/23"	1.4 (36)
12816-702	15	1.4	NEMA L5-15P	1 x 20A	(8) 5-20R	1U	19"EIA/23"	1.4 (36)
12816-705	20	1.9	NEMA 5-20P	1 x 20A	(8) 5-20R	1U	19"EIA/23"	1.4 (36)
12816-706	20	1.9	NEMA L5-20P	1 x 20A	(8) 5-20R	1U	19"EIA/23"	1.4 (36)
110-120 Volt, Single-Phase Power Strip, Surge-Protected								
12816-703	15	1.4	NEMA 5-15P	1 x 20A	(6) 5-20R	1U	19"EIA/23"	1.4 (36)
12816-704	15	1.4	NEMA L5-15P	1 x 20A	(6) 5-20R	1U	19"EIA/23"	1.4 (36)
12816-707	20	1.9	NEMA 5-20P	1 x 20A	(6) 5-20R	1U	19"EIA/23"	1.4 (36)
12816-708	20	1.9	NEMA L5-20P	1 x 20A	(6) 5-20R	1U	19"EIA/23"	1.4 (36)

Notes: Input current is the breaker rating. The Input Amp column lists the maximum rated value of the Input Plug/inlet and circuit breaker rating. UL/NEC regulatory code requires current ratings on product labels to be derated to 80% of the maximum rated values (for example: 20 Amp = 16 Amp on UL product label). For the Input kW column, all values are derated calculations per UL for use in North America. Input kW is the listed rating. Includes 19"EIA and 23"W horizontal rack-mount brackets. All power strips have IEC C20 inlets and include a power cord. Cords with locking plugs are 10'L (3 m). Cords with straight plugs are 8'2"L (2.4 m).

Metered Power Strips, Horizontal Rack-Mount

Part Number	Input			Output		Dims - in (mm)		
	Amp	kW	Plug	Breakers	Outlets	H	W	D
110-125 Volt, Single-Phase Power Strip								
13239-751	15	1.4	NEMA 5-15P	1 x 20A	(12) 5-20R	1U	19"EIA	4.6 (117)
13239-755	20	1.9	NEMA 5-20P	1 x 20A	(12) 5-20R	1U	19"EIA	4.6 (117)
13239-756	20	1.9	NEMA L5-20P	1 x 20A	(12) 5-20R	1U	19"EIA	4.6 (117)
110-125 Volt, Single-Phase Power Strip, Surge-Protected								
13239-753	15	1.4	NEMA 5-15P	1 x 20A	(12) 5-20R	1U	19"EIA	4.6 (117)
13239-757	20	1.9	NEMA 5-20P	1 x 20A	(12) 5-20R	1U	19"EIA	4.6 (117)
13239-758	20	1.9	NEMA L5-20P	1 x 20A	(12) 5-20R	1U	19"EIA	4.6 (117)

Notes: Input current is the breaker rating. The Input Amp column lists the maximum rated value of the Input Plug/inlet and circuit breaker rating. UL/NEC regulatory code requires current ratings on product labels to be derated to 80% of the maximum rated values (for example: 20 Amp = 16 Amp on UL product label). For the Input kW column, all values are derated calculations per UL for use in North America. Input kW is the listed rating. Includes 19"EIA and 23"W horizontal rack-mount brackets. All power strips have IEC C20 inlets and include a power cord. Cords with locking plugs are 10'L (3 m). Cords with straight plugs are 8'2"L (2.4 m).

Basic Power Strips for CUBE-iT® Cabinets

Part Number	Input			Output		Dims - in (mm)		
	Amp	kW	Plug	Breakers	Outlets	H	W	D
110-120 Volt, Single-Phase Power Strip								
12820-701	15	1.4	NEMA 5-15P	1 x 20A	(8) 5-20R	19.2 (488)	1.8 (44)	8.2 (208)
12820-702	15	1.4	NEMA L5-15P	1 x 20A	(8) 5-20R	19.2 (488)	1.8 (44)	8.2 (208)
12820-705	20	1.9	NEMA 5-20P	1 x 20A	(8) 5-20R	19.2 (488)	1.8 (44)	8.2 (208)
12820-706	20	1.9	NEMA L5-20P	1 x 20A	(8) 5-20R	19.2 (488)	1.8 (44)	8.2 (208)
110-120 Volt, Single-Phase Power Strip, Surge-Protected								
12820-703	15	1.4	NEMA 5-15P	1 x 20A	(6) 5-20R	19.2 (488)	1.8 (44)	8.2 (208)
12820-704	15	1.4	NEMA L5-15P	1 x 20A	(6) 5-20R	19.2 (488)	1.8 (44)	8.2 (208)
12820-707	20	1.9	NEMA 5-20P	1 x 20A	(6) 5-20R	19.2 (488)	1.8 (44)	8.2 (208)
12820-708	20	1.9	NEMA L5-20P	1 x 20A	(6) 5-20R	19.2 (488)	1.8 (44)	8.2 (208)

Notes: Dimensions include mounting bracket in vertical orientation. The Power Strip is 1.7"H (432 mm) x 1.7"W (43 mm) x 1.4"D (36 mm). All power strips have IEC C20 inlets and include a power cord. Cords with locking plugs are 10'L (3 m). Cords with straight plugs are 8'2"L (2.4 m).



International Power Strips

Specifications:

- Circuit Control:
 - Master lighted switch on horizontal rack-mount power strips
- Circuit Protection:
 - Thermal circuit breakers on vertical mount power strips
- Optional Surge Protection
 - 330 Volt, 1100 Joules
 - Surge suppression active indicator LED
- Current Metering:
 - Digital voltage and ammeter included on metered power strips
 - Meter has a 3-digit LED display
 - Overload alarm/flashing LED at breaker rating
- Mounting hardware/brackets:
 - Horizontal rack-mount power strips include mounting brackets for 19"W EIA and 23"W racks
 - Vertical mount power strips include tool-less buttons; order mounting brackets separately

Certifications:

- CE Marked

International Power Strips are not stocked in U.S., Canada or Latin America.

(See page 3-30 for Outlet and Input Plug Table)

Basic Power Strips, Vertical Mount

Part Number	Input			Output		Dims - in (mm)		
	Amp	kW*	Plug	Breakers	Outlets	H	W	D
220-250 Volt, Single-Phase Power Strip								
15642-202	16	4.0	IEC C20	1 x 16A	(10) C13, (4) C19	43.1 (1095)	2.5 (64)	1.8 (46)
15642-206	16	4.0	IEC C20	1 x 16A	(12) UK BS1363 13A	48.3 (1227)	2.5 (64)	1.8 (46)
15642-212	16	4.0	IEC 16A 1P+N+E	1 x 16A	(10) C13, (4) C19	43.1 (1095)	2.5 (64)	1.8 (46)
15642-216	16	4.0	IEC 16A 1P+N+E	1 x 16A	(12) UK BS1363 13A	48.3 (1227)	2.5 (64)	1.8 (46)
15642-222	32	8.0	IEC 32A 1P+N+E	2 x 16A	(10) C13, (4) C19	48.3 (1227)	2.5 (64)	1.8 (46)
15642-226	32	8.0	IEC 32A 1P+N+E	2 x 16A	(12) UK BS1363 13A	53.4 (1357)	2.5 (64)	1.8 (46)
15642-232	13	3.3	UK BS1363	1 x 13A	(10) C13, (4) C19	43.1 (1095)	2.5 (64)	1.8 (46)
15642-236	13	3.3	UK BS1363	1 x 13A	(12) UK BS1363 13A	48.3 (1227)	2.5 (64)	1.8 (46)
15644-202	16	4.0	IEC C20	1 x 16A	(20) C13, (4) C19	61.3 (1557)	2.5 (64)	1.8 (46)
15644-205	16	4.0	IEC C20	1 x 16A	(24) Schuko DIN49440 16A	61.0 (1549)	1.8 (46)	2.7 (69)
15644-207	16	4.0	IEC C20	1 x 16A	(24) Universal GB2009.3 10A	61.3 (1557)	2.5 (64)	1.8 (46)
15644-208	16	4.0	IEC C20	1 x 16A	(20) CH GB1002 10A, (4) 16A	61.3 (1557)	2.5 (64)	1.8 (46)
15644-212	16	4.0	IEC 16A 1P+N+E	1 x 16A	(20) C13, (4) C19	61.3 (1557)	2.5 (64)	1.8 (46)
15644-215	16	4.0	IEC 16A 1P+N+E	1 x 16A	(24) Schuko DIN49440 16A	61.0 (1549)	1.8 (46)	2.7 (69)
15644-217	16	4.0	IEC 16A 1P+N+E	1 x 16A	(24) Universal GB2009.3 10A	61.3 (1557)	2.5 (64)	1.8 (46)
15644-218	16	4.0	IEC 16A 1P+N+E	1 x 16A	(20) CH GB1002 10A, (4) 16A	61.3 (1557)	2.5 (64)	1.8 (46)
15644-222	32	8.0	IEC 32A 1P+N+E	2 x 16A	(20) C13, (4) C19	66.5 (1689)	2.5 (64)	1.8 (46)
15644-225	32	8.0	IEC 32A 1P+N+E	2 x 16A	(24) Schuko DIN49440 16A	64.8 (1646)	1.8 (46)	2.7 (69)
15644-227	32	8.0	IEC 32A 1P+N+E	2 x 16A	(24) Universal GB2009.3 10A	66.5 (1689)	2.5 (64)	1.8 (46)
15644-228	32	8.0	IEC 32A 1P+N+E	2 x 16A	(20) CH GB1002 10A, (4) 16A	66.5 (1689)	2.5 (64)	1.8 (46)
15644-232	13	3.3	UK BS1363	1 x 13A	(20) C13, (4) C19	61.3 (1557)	2.5 (64)	1.8 (46)
15644-237	13	3.3	UK BS1363	1 x 13A	(24) Universal GB2009.3 10A	61.3 (1557)	2.5 (64)	1.8 (46)
220-250 Volt, Single-Phase Power Strip, Surge-Protected								
15642-102	16	4.0	IEC C20	1 x 16A	(10) C13, (4) C19	43.1 (1095)	2.5 (64)	1.8 (46)
15642-106	16	4.0	IEC C20	1 x 16A	(12) UK BS1363 13A	48.3 (1227)	2.5 (64)	1.8 (46)
15642-112	16	4.0	IEC 16A 1P+N+E	1 x 16A	(10) C13, (4) C19	43.1 (1095)	2.5 (64)	1.8 (46)
15642-116	16	4.0	IEC 16A 1P+N+E	1 x 16A	(12) UK BS1363 13A	48.3 (1227)	2.5 (64)	1.8 (46)
15642-122	32	8.0	IEC 32A 1P+N+E	2 x 16A	(10) C13, (4) C19	48.3 (1227)	2.5 (64)	1.8 (46)
15642-126	32	8.0	IEC 32A 1P+N+E	2 x 16A	(12) UK BS1363 13A	53.4 (1357)	2.5 (64)	1.8 (46)
15642-132	13	3.3	UK BS1363	1 x 13A	(10) C13, (4) C19	43.1 (1095)	2.5 (64)	1.8 (46)
15642-136	13	3.3	UK BS1363	1 x 13A	(12) UK BS1363 13A	48.3 (1227)	2.5 (64)	1.8 (46)

Notes: All power strips have attached 10'L (3 m) power cord. *kW values are at a Nominal voltage of 250V.



15644-222 shown

Basic Power Strips, Vertical Mount

Part Number	Input			Output		Dims - in (mm)		
	Amp	kW*	Plug	Breakers	Outlets	H	W	D
220-250 Volt, Single-Phase Power Strip, Surge-Protected								
15644-102	16	4.0	IEC C20	1 x 16A	(20) C13, (4) C19	61.3 (1557)	2.5 (64)	1.8 (46)
15644-105	16	4.0	IEC C20	1 x 16A	(24) Schuko DIN49440 16A	61.0 (1549)	1.8 (46)	2.7 (69)
15644-107	16	4.0	IEC C20	1 x 16A	(24) Universal GB2009.3 10A	61.3 (1557)	2.5 (64)	1.8 (46)
15644-108	16	4.0	IEC C20	1 x 16A	(20) CH GB1002 10A, (4) 16A	61.3 (1557)	2.5 (64)	1.8 (46)
15644-112	16	4.0	IEC 16A 1P+N+E	1 x 16A	(20) C13, (4) C19	61.3 (1557)	2.5 (64)	1.8 (46)
15644-115	16	4.0	IEC 16A 1P+N+E	1 x 16A	(24) Schuko DIN49440 16A	61.0 (1549)	1.8 (46)	2.7 (69)
15644-117	16	4.0	IEC 16A 1P+N+E	1 x 16A	(24) Universal GB2009.3 10A	61.3 (1557)	2.5 (64)	1.8 (46)
15644-118	16	4.0	IEC 16A 1P+N+E	1 x 16A	(20) CH GB1002 10A, (4) 16A	61.3 (1557)	2.5 (64)	1.8 (46)
15644-122	32	8.0	IEC 32A 1P+N+E	2 x 16A	(20) C13, (4) C19	66.5 (1689)	2.5 (64)	1.8 (46)
15644-125	32	8.0	IEC 32A 1P+N+E	2 x 16A	(24) Schuko DIN49440 16A	64.8 (1646)	1.8 (46)	2.7 (69)
15644-127	32	8.0	IEC 32A 1P+N+E	2 x 16A	(24) Universal GB2009.3 10A	66.5 (1689)	2.5 (64)	1.8 (46)
15644-128	32	8.0	IEC 32A 1P+N+E	2 x 16A	(20) CH GB1002 10A, (4) 16A	66.5 (1689)	2.5 (64)	1.8 (46)
15644-132	13	3.3	UK BS1363	1 x 13A	(20) C13, (4) C19	61.3 (1557)	2.5 (64)	1.8 (46)
15644-137	13	3.3	UK BS1363	1 x 13A	(24) Universal GB2009.3 10A	61.3 (1557)	2.5 (64)	1.8 (46)

Notes: All power strips have attached 10'L (3 m) power cord. *kW values are at a Nominal voltage of 250V.

Metered Power Strips, Vertical Mount

Part Number	Input			Output		Dims - in (mm)		
	Amp	kW*	Plug	Breakers	Outlets	H	W	D
220-250 Volt, Single-Phase Power Strip								
15643-202	16	4.0	IEC C20	1 x 16A	(10) C13, (4) C19	43.1 (1095)	2.5 (64)	1.8 (46)
15643-206	16	4.0	IEC C20	1 x 16A	(12) UK BS1363 13A	48.3 (1227)	2.5 (64)	1.8 (46)
15643-212	16	4.0	IEC 16A 1P+N+E	1 x 16A	(10) C13, (4) C19	43.1 (1095)	2.5 (64)	1.8 (46)
15643-216	16	4.0	IEC 16A 1P+N+E	1 x 16A	(12) UK BS1363 13A	48.3 (1227)	2.5 (64)	1.8 (46)
15643-222	32	8.0	IEC 32A 1P+N+E	2 x 16A	(10) C13, (4) C19	48.3 (1227)	2.5 (64)	1.8 (46)
15643-226	32	8.0	IEC 32A 1P+N+E	2 x 16A	(12) UK BS1363 13A	53.4 (1357)	2.5 (64)	1.8 (46)
15643-232	13	3.3	UK BS1363	1 x 13A	(10) C13, (4) C19	43.1 (1095)	2.5 (64)	1.8 (46)
15643-236	13	3.3	UK BS1363	1 x 13A	(12) UK BS1363 13A	48.3 (1227)	2.5 (64)	1.8 (46)
15645-202	16	4.0	IEC C20	1 x 16A	(20) C13, (4) C19	61.3 (1557)	2.5 (64)	1.8 (46)
15645-205	16	4.0	IEC C20	1 x 16A	(24) Schuko DIN49440 16A	61.0 (1549)	1.8 (46)	2.7 (69)
15645-207	16	4.0	IEC C20	1 x 16A	(24) Universal GB2009.3 10A	61.3 (1557)	2.5 (64)	1.8 (46)
15645-208	16	4.0	IEC C20	1 x 16A	(20) CH GB1002 10A, (4) 16A	61.3 (1557)	2.5 (64)	1.8 (46)
15645-212	16	4.0	IEC 16A 1P+N+E	1 x 16A	(20) C13, (4) C19	61.3 (1557)	2.5 (64)	1.8 (46)
15645-215	16	4.0	IEC 16A 1P+N+E	1 x 16A	(24) Schuko DIN49440 16A	61.0 (1549)	1.8 (46)	2.7 (69)
15645-217	16	4.0	IEC 16A 1P+N+E	1 x 16A	(24) Universal GB2009.3 10A	61.3 (1557)	2.5 (64)	1.8 (46)
15645-218	16	4.0	IEC 16A 1P+N+E	1 x 16A	(20) CH GB1002 10A, (4) 16A	61.3 (1557)	2.5 (64)	1.8 (46)
15645-222	32	8.0	IEC 32A 1P+N+E	2 x 16A	(20) C13, (4) C19	66.5 (1689)	2.5 (64)	1.8 (46)
15645-225	32	8.0	IEC 32A 1P+N+E	2 x 16A	(24) Schuko DIN49440 16A	64.8 (1646)	1.8 (46)	2.7 (69)
15645-227	32	8.0	IEC 32A 1P+N+E	2 x 16A	(24) Universal GB2009.3 10A	66.5 (1689)	2.5 (64)	1.8 (46)
15645-228	32	8.0	IEC 32A 1P+N+E	2 x 16A	(20) CH GB1002 10A, (4) 16A	66.5 (1689)	2.5 (64)	1.8 (46)
15645-232	13	3.3	UK BS1363	1 x 13A	(20) C13, (4) C19	61.3 (1557)	2.5 (64)	1.8 (46)
15645-237	13	3.3	UK BS1363	1 x 13A	(24) Universal GB2009.3 10A	61.3 (1557)	2.5 (64)	1.8 (46)

*kW values are at a Nominal voltage of 250V.

Metered Power Strips, Vertical Mount

Part Number	Input			Breakers	Output	Dims - in (mm)		
	Amp	kW*	Plug		Outlets	H	W	D
220-250 Volt, Single-Phase Power Strip, Surge-Protected								
15643-102	16	4.0	IEC C20	1 x 16A	(10) C13, (4) C19	43.1 (1095)	2.5 (64)	1.8 (46)
15643-106	16	4.0	IEC C20	1 x 16A	(12) UK BS1363 13A	48.3 (1227)	2.5 (64)	1.8 (46)
15643-112	16	4.0	IEC 16A 1P+N+E	1 x 16A	(10) C13, (4) C19	43.1 (1095)	2.5 (64)	1.8 (46)
15643-116	16	4.0	IEC 16A 1P+N+E	1 x 16A	(12) UK BS1363 13A	48.3 (1227)	2.5 (64)	1.8 (46)
15643-122	32	8.0	IEC 32A 1P+N+E	2 x 16A	(10) C13, (4) C19	48.3 (1227)	2.5 (64)	1.8 (46)
15643-126	32	8.0	IEC 32A 1P+N+E	2 x 16A	(12) UK BS1363 13A	53.4 (1357)	2.5 (64)	1.8 (46)
15643-132	13	3.3	UK BS1363	1 x 13A	(10) C13, (4) C19	43.1 (1095)	2.5 (64)	1.8 (46)
15643-136	13	3.3	UK BS1363	1 x 13A	(12) UK BS1363 13A	48.3 (1227)	2.5 (64)	1.8 (46)
15645-102	16	4.0	IEC C20	1 x 16A	(20) C13, (4) C19	61.3 (1557)	2.5 (64)	1.8 (46)
15645-105	16	4.0	IEC C20	1 x 16A	(24) Schuko DIN49440 16A	61.0 (1549)	1.8 (46)	2.7 (69)
15645-107	16	4.0	IEC C20	1 x 16A	(24) Universal GB2009.3 10A	61.3 (1557)	2.5 (64)	1.8 (46)
15645-108	16	4.0	IEC C20	1 x 16A	(20) CH GB1002 10A, (4) 16A	61.3 (1557)	2.5 (64)	1.8 (46)
15645-112	16	4.0	IEC 16A 1P+N+E	1 x 16A	(20) C13, (4) C19	61.3 (1557)	2.5 (64)	1.8 (46)
15645-115	16	4.0	IEC 16A 1P+N+E	1 x 16A	(24) Schuko DIN49440 16A	61.0 (1549)	1.8 (46)	2.7 (69)
15645-117	16	4.0	IEC 16A 1P+N+E	1 x 16A	(24) Universal GB2009.3 10A	61.3 (1557)	2.5 (64)	1.8 (46)
15645-118	16	4.0	IEC 16A 1P+N+E	1 x 16A	(20) CH GB1002 10A, (4) 16A	61.3 (1557)	2.5 (64)	1.8 (46)
15645-122	32	8.0	IEC 32A 1P+N+E	2 x 16A	(20) C13, (4) C19	66.5 (1689)	2.5 (64)	1.8 (46)
15645-125	32	8.0	IEC 32A 1P+N+E	2 x 16A	(24) Schuko DIN49440 16A	64.8 (1646)	1.8 (46)	2.7 (69)
15645-127	32	8.0	IEC 32A 1P+N+E	2 x 16A	(24) Universal GB2009.3 10A	66.5 (1689)	2.5 (64)	1.8 (46)
15645-128	32	8.0	IEC 32A 1P+N+E	2 x 16A	(20) CH GB1002 10A, (4) 16A	66.5 (1689)	2.5 (64)	1.8 (46)
15645-132	13	3.3	UK BS1363	1 x 13A	(20) C13, (4) C19	61.3 (1557)	2.5 (64)	1.8 (46)
15645-137	13	3.3	UK BS1363	1 x 13A	(24) Universal GB2009.3 10A	61.3 (1557)	2.5 (64)	1.8 (46)

Notes: All power strips have attached 10'L (3 m) power cord. *kW values are at a Nominal voltage of 250V.



The Power Selector enables you to select the best power product for your application by narrowing down options based on your requirements. After you're done comparing, you can email or print the results. Visit selectapdu.com to access the Power Selector.

Basic Power Strips, Horizontal Rack-Mount

Part Number	Input			Output		Dims - in (mm)		
	Amp	kW*	Plug	Control	Outlets	H	W	D
220-250 Volt, Single-Phase Power Strip								
15640-201	16	4.0	IEC C20	Master Lighted Switch	(10) C13	1U	19"EIA/23"	1.8 (46)
15640-202	16	4.0	IEC C20	Master Lighted Switch	(6) C13, (4) C19	1U	19"EIA/23"	4.6 (117)
15640-203	16	4.0	IEC C20	Master Lighted Switch	(4) C19	1U	19"EIA/23"	1.8 (46)
15640-204	16	4.0	IEC C20	Master Lighted Switch	(6) CH GB1002 10A	1U	19"EIA/23"	1.8 (46)
15640-205	16	4.0	IEC C20	Master Lighted Switch	(6) Schuko DIN49440 16A	1U	19"EIA/23"	1.8 (46)
15640-206	16	4.0	IEC C20	Master Lighted Switch	(6) UK BS1363 13A	1U	19"EIA/23"	1.8 (46)
15640-207	16	4.0	IEC C20	Master Lighted Switch	(6) Universal GB2009.3 10A	1U	19"EIA/23"	1.8 (46)
15640-211	16	4.0	IEC 16A 1P+N+E	Master Lighted Switch	(10) C13	1U	19"EIA/23"	1.8 (46)
15640-212	16	4.0	IEC 16A 1P+N+E	Master Lighted Switch	(6) C13, (4) C19	1U	19"EIA/23"	4.6 (117)
15640-213	16	4.0	IEC 16A 1P+N+E	Master Lighted Switch	(4) C19	1U	19"EIA/23"	1.8 (46)
15640-214	16	4.0	IEC 16A 1P+N+E	Master Lighted Switch	(6) CH GB1002 10A	1U	19"EIA/23"	1.8 (46)
15640-215	16	4.0	IEC 16A 1P+N+E	Master Lighted Switch	(6) Schuko DIN49440 16A	1U	19"EIA/23"	1.8 (46)
15640-216	16	4.0	IEC 16A 1P+N+E	Master Lighted Switch	(6) UK BS1363 13A	1U	19"EIA/23"	1.8 (46)
15640-217	16	4.0	IEC 16A 1P+N+E	Master Lighted Switch	(6) Universal GB2009.3 10A	1U	19"EIA/23"	1.8 (46)
15640-231	13	3.3	UK BS1363	Master Lighted Switch	(10) C13	1U	19"EIA/23"	1.8 (46)
15640-232	13	3.3	UK BS1363	Master Lighted Switch	(6) C13, (4) C19	1U	19"EIA/23"	4.6 (117)
15640-236	13	3.3	UK BS1363	Master Lighted Switch	(6) UK BS1363 13A	1U	19"EIA/23"	1.8 (46)

Notes: Includes 19"EIA and 23"W horizontal rack-mount brackets. All power strips have a lighted master switch (no breaker) and an attached 10'L (3 m) cord.
*kW values are at a Nominal voltage of 250V.

+ power Simplify ordering, shipping and installation by requesting eConnect PDUs and eConnect RFID Electronic Lock Kit to be installed in CPI's ZetaFrame cabinets before they leave the factory. Request Redundancy Pack for easy identification of primary and secondary units.

Add power. Make it easy.



17763-007 shown.

IEC C20 PDU Input Power Cords

Input power cords for use with PDUs and Power Strips that have IEC C20 inlets.

- Select power cord to match power connection in the facility
- IEC C19 Connector attaches to the C20 Inlet on the PDU
- Sold individually, order (1) power cord per PDU



17763-010 shown.



17763-013 shown.

Part Number	Description	Shipping Weight lb (kg)
17763-001	PDU Input Power Cord, 110-125 VAC or 200-240 VAC, IEC C19 Connector to IEC C20 Plug, 10'L (3 m)	3 (1.4)
17763-002	PDU Input Power Cord, 110-125 VAC, IEC C19 Connector to NEMA 5-15P Plug, 8'2"L (2.4 m)	3 (1.4)
17763-003	PDU Input Power Cord, 110-125 VAC, IEC C19 Connector to NEMA 5-20P Plug, 8'2"L (2.4 m)	3 (1.4)
17763-004	PDU Input Power Cord, 200-240 VAC, IEC C19 Connector to NEMA 6-15P Plug, 8'2"L (2.4 m)	3 (1.4)
17763-005	PDU Input Power Cord, 200-240 VAC, IEC C19 Connector to NEMA 6-20P Plug, 8'2"L (2.4 m)	3 (1.4)
17763-006	PDU Input Power Cord, 110-125 VAC, IEC C19 Connector to NEMA L5-15P Plug, 10'L (3 m)	3 (1.4)
17763-007	PDU Input Power Cord, 110-125 VAC, IEC C19 Connector to NEMA L5-20P Plug, 10'L (3 m)	3 (1.4)
17763-008	PDU Input Power Cord, 200-240 VAC, IEC C19 Connector to NEMA L6-15P Plug, 10'L (3 m)	3 (1.4)
17763-010	PDU Input Power Cord, 200-240 VAC, IEC C19 Connector to IEC 16A 1P+N+E Plug, 10'L (3 m)	3 (1.4)
17763-011	PDU Input Power Cord, 200-240 VAC, IEC C19 Connector to 16A CEE7/7 Schuko Plug (Europe), 8'2"L (2.4 m)	3 (1.4)
17763-012	PDU Input Power Cord, 200-240 VAC, IEC C19 Connector to BS1363 Plug (Britains), 8'2"L (2.4 m)	3 (1.4)
17763-013	PDU Input Power Cord, 200-240 VAC, IEC C19 Connector to CEI23 Plug (Italian), 8'2"L (2.4 m)	3 (1.4)

Additional PDU Accessories



38645-700

Part Number	Description	Shipping Weight lb (kg)
17762-003	Cord Retention Tethers, Pack of 50	1 (0.5)
17762-002	Ground Wire Kit	1 (0.5)
17762-001	Tool-less Mounting Hardware Kit, Pack of 2	1 (0.5)
38645-700	Standard PDU Bracket for ZetaFrame Cabinet	2 (0.9)
35700-701	Mounting Bracket for Rack Systems	2 (0.9)

Note: Mounting Brackets are included with CPI Cabinets. Brackets for Cabinet Systems support two 2.2"W (56 mm) PDUs side-by-side or one 2.7"W (69 mm) PDU.

Remote Infrastructure Management (RIM) Protocol Converter

The Protocol Converter is ideal for environments where data from monitored equipment is incompatible with the protocols used by the BMS or NMS, especially in applications that feature legacy monitoring systems.

- Multiple input and output protocols allow easy integration with a wide variety of equipment
- Communicates with building management and network management systems
- Web-based interface simplifies setup and configuration
- Connects up to 32 devices (units, modules, or nodes)
- Monitors up to 1,024 Modbus registers, OID, or instances
- Use the dual port Protocol Converter to connect to multiple trunk lines for faster polling with a large number of devices
- Alarm notification through email when a device stops communicating



60106-001
Single Port



60106-002
Dual Port

Part Number	Description	Shipping Weight lb (kg)
60106-001	RIM Protocol Converter, SNMP/Modbus/BACnet, Single Port, black	5 (2.3)
60106-002	RIM Protocol Converter, SNMP/Modbus/BACnet, Dual Port, Black	5 (2.3)

Note: Includes (1) Protocol Converter, (1) external power supply and (1) network crossover cabler for initial configuration.



RIM-1000
Front view



RIM-1000
Rear view

Remote Infrastructure Management (RIM-1000)

Features:

- Remote monitoring of sensors and devices in your data centers and equipment rooms
- Configurable with expansion cards for a large number of sensor inputs
- Provides one integrated view of all facility equipment
- Accepts inputs from a wide range of environmental sensors and facility equipment
- Stores data internally, so there is no need for additional equipment or software to store or access data
- Provides a single web-based interface for accessing and reviewing all data
- Monitors user-set thresholds and sends SNMP traps, email or SMS alarm notifications for events
- Provides Modbus, BACnet and SNMP output for integration with other facility management systems

Certifications:

- CE
- ETL listed: conforms to UL 61010-1, EN 61010-1 Certified to CSA C22.2 NO. 61010-1
- RoHS compliant

Expansion Cards (RIM-1000)

You can add expansion cards to the RIM-1000 to provide additional connections for external sensors and additional relay outputs. When selecting an expansion card, check your RIM-1000 to be sure there is an open expansion card slot and be sure to match the input voltage of your RIM-1000 (24 VDC or 48 VDC).

Part Number	Description	Shipping Weight lb (kg)
60103-001	Expansion Card A, for 24 VDC or 48VDC RIM-1000, 12 configurable analog or digital NO inputs*, 8 relay outputs (maximum one can be installed in a 48 VDC RIM-1000)	1 (0.5)
60103-002	Expansion Card C, for 24 VDC RIM-1000, 24 digital NO/NC inputs	1 (0.5)

Note: 1U units have 1 expansion card slot. 2U units have 4 expansion card slots. An internal modem (for pager and PPP/dialup connections), and wall mount brackets are also available.

Specifications/RIM-1000:

- Includes:
 - (1) RIM-1000; (1) Power Supply with 24VDC models only and (1) Rack-mount brackets
- Power:
 - 1U, 24VDC Model: 24VDC ($\pm 10\%$), 1A max., external power supply included
 - 1U, 48VDC Model: 36-72VDC, 0.5A max., power input terminal block
 - 2U, 24VDC Model: 24VDC ($\pm 10\%$), 2.5A max., external power supply included
 - 2U, 48VDC Model: 36-72VDC, 1.25A max., power input terminal block
- Grounding: External ground point for chassis and EIA-485
- Inputs:
 - Analog/Digital: 8 Configurable as 4-20mA (12-bit A/D conversion) or Dry Contact NO/NC (<25mA)
 - Keypad: Standard 3x4; 3000VAC RMS optically isolated; 20 User Access Codes (accessible via phone/DTMF through modem)
- Outputs:
 - Relay: 2 Dry Contact, Form C, 1A @ 24VDC, 0.5A resistive @ 120VAC (controllable via user programmable logic)
 - Sensor/Accessory Power: 24VDC ($\pm 10\%$) @ 300mA max. (power for external sensors and/or devices)
- Expansion Cards:
 - 1U model accommodates 1 expansion card
 - 2U model accommodates up to 4 expansion cards
 - 24VDC model requires 24VDC expansion cards
 - 48VDC model requires 48VDC expansion cards
 - Expansion Card A: 12 analog (jumper selectable for 4-20mA, 0-5VDC or 0-10VDC) or digital normally open (NO) dry contact inputs (non-isolated, individual ground only); and 8 Form C Relay Outputs, 1A @ 24VDC, 0.5A resistive @ 120VAC. 48VDC model accepts only 1 Card A.
 - Expansion Card C: 24 digital normally open or normally closed dry contact inputs, 3000VAC RMS optically isolated (common or individual ground)
- Communication Ports:
 - Ethernet: 10/100BaseT, RJ45 connector; 500VAC RMS isolation
 - RS-232: DB9 female connector; 9600 baud; 3000VAC RMS optically isolated; 15kV ESD protection
 - EIA-485 (selectable as RS-232): Two-wire half duplex; terminal block (selecting RS-232 switches to DB9 male connector); 1200, 2400, or 9600 baud configurable; 3000VAC RMS optically isolated 3000VAC RMS optically isolated
 - Modem (RJ11 Telco; ordered separately): V.34bis/33.6 kbps; DTMF capable; PPP-enabled; FCC Part 68 approved; 1500VAC RMS isolation barrier; 2100V peak surge protection
- Protocols:
 - TCP/IP; UDP/IP; ICMP/IP; FTP; NTP: IPv4
 - HTTP/HTML; SNMP; Telnet: 1.1/4.0; up to 10 URL links to other IP addressable cameras/devices; Webpages comply with Rehabilitation Act of 1973, sections 504 and 508, US Dept. of Education with disabilities)
 - SNMP: V1: MIB-2 compliant; NMS Manageable with Get, Set, and Traps; V2c: Traps or Informs
 - SMTP (email): Supports Client Authentication (plain and login); compatible with ESMTP Servers
- Protocols:
 - Modbus: RTU transmission protocol; function codes: Slave - 03; Master - 01,02,03,04
 - Modbus/IP: Modbus Slave; TCP/IP transmission protocol; Reads up to 628 registers and converts to SNMP and BACnet
 - BACnet/IP: Reads up to 106 instances and converts to SNMP and Modbus
 - Terminal Emulation: VT100 compatible
 - TAP (Pager): Telocator Alphanumeric Protocol v1.8
- Alarm Notification
 - Pager (With Optional Modem) – Optional: 15 text, numeric, or alphanumeric pager numbers
 - Email (Ethernet, With Optional Modem through PPP): 8 email recipients; email sent on Alarm and Return To Normal
 - SNMP Traps (Ethernet): V1 and V2c: 4 Trap IPs/Community Strings
 - Escalation (with Optional Modem): Additional notification to 1 of the 15 pager numbers when the initial page results in a Failure To Acknowledge status
- Health Check/Self-Monitoring: Self resetting; captured in Log
- Internal Hardware:
 - Real Time Clock: Battery backed; ± 1.53 min/month accuracy
 - Memory: 16MB RAM; 128K NVRAM; 16MB Flash
- Logging Capabilities:
 - Alarm Log: Last 256 Alarms
 - Event Log: Last 100 Events
- Logging Capabilities:
 - Web User Access Log: Last 100 HTML Accesses
 - Digital Status Log: Last 100 Digital Status entries
 - Trending of Analog Inputs: 244 entries per time frame, per channel. High, low, and average values logged
 - Extended Trending (Analog Inputs): 3,840 entries over 32 inputs, physical or over Modbus. Logging at defined, user-selectable intervals.
- Login Security:
 - Web Browser Access (Ethernet, Modem, PPP): 1 Administrator plus 7 users
 - Terminal Emulation Access (Modem): 1 Administrator
- Front Panel Interface: 1 on/off power switch. Red and green LEDs indicate status, network link, network and modem activity
- Operating/Storage Environment:
 - Operating temperature: 32° to 158°F (0° to 70°C).
 - Humidity: 5% to 95% RH, non-condensing.
 - Altitude: 15,000ft (4,572m) max.
 - Storage temperature: -40° to 185°F (-40°C to 85°C)
- Dimensions and Weight:
 - 1U model: 1.8"H x 16.8"W x 7.9"D (46mmH x 427mmW x 201mmD); 6 lb (2.72 kg)
 - 2U model: 3.5"H x 16.8"W x 7.9"D (89mmH x 427mmW x 201mmD); 10 lb (4.54 kg)
- Mounting: 19" EIA, rack-mount brackets included; wall mount brackets available (sold separately)

Ordering Information:



RIM-1000
Shown

Part Number	(RIM-1000) System – 24 VDC Models	Shipping Weight lb (kg)
60101-001	1U, 24VDC, 8 configurable analog or digital NO/NC inputs, 2 relay outputs, 1 open expansion card slot, black	11 (5.0)
60101-002	1U, 24VDC, 8 configurable analog or digital NO/NC inputs, 12 configurable analog or digital NO inputs*, 10 relay outputs, no open expansion card slots, black	11 (5.0)
60101-003	1U, 24VDC, 8 configurable analog or digital NO/NC inputs, 24 digital NO/NC input, 2 relay outputs, no open expansion card slots, black	11 (5.0)
60101-004	2U, 24VDC, 8 configurable analog or digital NO/NC inputs, 2 relay outputs, 4 open expansion card slots, black	16 (7.3)
60101-005	2U, 24VDC, 8 configurable analog or digital NO/NC inputs, 12 configurable analog or digital NO inputs*, 10 relay outputs, 3 open expansion card slots, black	16 (7.3)
60101-006	2U, 24VDC, 8 configurable analog or digital NO/NC inputs, 24 digital NO/NC inputs, 2 relay outputs, 3 open expansion card slots, black	16 (7.3)
60101-007	2U, 24VDC, 8 configurable analog or digital NO/NC inputs, 12 configurable analog or digital NO inputs*, 24 digital NO/NC inputs, 10 relay outputs, 2 open expansion card slots, black	16 (7.3)
60101-008	2U, 24VDC, 8 configurable analog or digital NO/NC inputs, 24 configurable analog or digital NO inputs*, 18 relay outputs, 2 open expansion card slots, black	16 (7.3)
60101-009	2U, 24VDC, 8 configurable analog or digital NO/NC inputs, 48 digital NO/NC inputs, 2 relay outputs, 2 open expansion card slots, black	16 (7.3)
60101-010	2U, 24VDC, 8 configurable analog or digital NO/NC inputs, 48 configurable analog or digital NO inputs*, 34 relay outputs, no open expansion card slots, black	16 (7.3)
60101-011	2U, 24VDC, 8 configurable analog or digital NO/NC inputs, 96 digital NO/NC inputs, 2 relay outputs, no open expansion card slots, black	16 (7.3)
60101-012	2U, 24VDC, 8 configurable analog or digital NO/NC inputs, 12 configurable analog or digital NO inputs*, 72 digital NO/NC inputs, 10 relay outputs, no open expansion card slots, black	16 (7.3)

Note: The 12/24/48 configurable analog or digital NO inputs in these models are configured for a 4-20mA input, but can be manually reconfigured to 0-5 VDC or 0-10 VDC inputs by changing jumper settings on the expansion card. 48 VDC Models are also available. Refer to the Technical Data Sheet for detailed specifications.*



60114-002
shown

Note: Each combination Temperature and Humidity Sensor uses two Analog Inputs on the RIM-1000, one for temperature and one for humidity. Use Leak Spot Detector to monitor a specific spot for liquid. Use Leak Detection Controller Kit and additional Sensor Rope, if needed, to monitor an area. Leak Detection Controller Kit uses two digital inputs on the RIM-1000, one for leak detection and one for cable break. Sensors require power from the RIM-1000 or another power source. Refer to the Data Sheet for sensor specifications.

Sensors

Part Number	Analog Input, Sensors for RIM-1000	Shipping Weight lb (kg)
60111-001	Temperature Sensor, No Display, 50°F to 95°F (10°C to 35°C)	1 (0.5)
60111-006	Temperature and Humidity Sensor, No Display, 3% Accuracy RH, Selectable Temperature Range -20°F to 140°F (-28.9°C to 60°C); 0°F to 100°F (-17.8°C to 37.8°C); 40°F to 90°F (4.4°C to 32.3°C); or -4°F to 140°F (-20°C to 60°C),	1 (0.5)
60111-007	Temperature and Humidity Sensor, With Display, 3% Accuracy RH, Selectable Temperature Range -20°F to 140°F (-28.9°C to 60°C); 0°F to 100°F (-17.8°C to 37.8°C); 40°F to 90°F (4.4°C to 32.3°C); or -4°F to 140°F (-20°C to 60°C),	1 (0.5)
Digital Input, Sensors for RIM-1000		
60109-001	Leak Spot Detector, with 14'L (4.2 m) cable	1 (0.5)
60109-002	Leak Detection Controller Kit, 10 ft (3 m) Sensor Rope, Power Supply	1 (0.5)
60109-003	Leak Detection Sensor Rope, 10 ft L (3.0 m)	1 (0.5)
60109-004	Leak Detection Sensor Rope, 25 ft L (7.6 m)	1 (0.5)
60109-005	Leak Detection Sensor Rope, 50 ft L (15.2 m)	3 (1.4)
60109-006	J-Clips, adhesive backing, to install Sensor Rope, Pack of 10	1 (0.5)
60109-007	J-Clips, adhesive backing, to install Sensor Rope, Pack of 50	1 (0.5)
60110-001	Power Fail Monitor, with one 120 VAC, 15A (NEMA 5-15P) connection	1 (0.5)
60113-001	Smoke Detector	1 (0.5)
60114-001	Motion Sensor	1 (0.5)
60115-001	Magnetic Door Sensor	1 (0.5)



RIM-750
Front view



RIM-750
Rear view

Remote Infrastructure Management (RIM-750)

Features:

- Remote monitoring of sensors in computer and network equipment rooms
- Simple installation and setup
- Web-accessible with a clean, easy-to-use, mobile-friendly web interface that displays sensor readings and trends
- Monitors 8 digital inputs and 4 temperature or temperature/humidity sensors, plus one zone of leak detection with up to 200 feet (60 meters) of Sensor Rope
- USB power inlet allows you to power RIM-750 with the included wall adapter or a USB port on a server or other device, such as the eConnect PDU
- Multiple alarm notification configurations, including audible and visible indicators, email messaging and/or relay activation
- Relay output allows for simple control of an external device upon alarm condition
- Modbus or SNMP output enables simple integration with other facility management systems (BMS)
- Integrated logging and trending, including CSV downloadable trending data

Part Number	Description	Shipping Weight lb (kg)
60100-001	RIM-750, with 4 Temperature/Humidity inputs, 8 digital inputs, 1 leak detection input, 1 relay output, black	2 (0.9)
60100-002	RIM-750 and Leak Detection Kit Bundle, includes 1 RIM-750 with a Leak Detection Lead Cable and 200' (60 m) of Leak Detection Sensor Rope	9 (4.1)

Certifications:

- CE
- ETL listed: conforms to UL 61010-1, EN 61010-1 Certified to CSA C22.2 NO. 61010-1
- RoHS compliant

Specifications:

- Includes:
 - (1) RIM-750, (1) network cable, 3.3 ft (1m) long, (1) USB power adapter with USB mini B to USB A cable
- Power:
 - Power with included wall adapter or from USB port with 5VDC @ 500mA max. output
 - USB mini-B power inlet, (US) 5VDC @ 500mA max.
 - Includes a 110/240VAC 50/60Hz wall adapter with US (type "A") outlet blade and type "C", "G" & "I" adapter blades
- Wired Inputs:
 - Temperature/Humidity: 4 each, 1-wire digital temperature or 1-wire digital temperature/humidity sensor inputs; plug-and-play; configurable alarm points
 - Digital: 8 each, digital alarm points; configurable
 - Leak Detection: 1 each, zone leak detection, supports 200 ft (60 m) of conductive fluid Sensor Rope; Leak Detection Lead Cable and Sensor Rope(s) must be ordered separately
- Relay Output:
 - 1 each, Form C summary relay; 2A @ 30VDC, 0.5A @125VAC; configurable as summary alarm output or manual operation
- Alarm Notification:
 - Panel: Audible alarm, visible LED
 - Integrated Web Interface: Dashboard overview with alarm indicators
 - Email: up to 8 email recipients; email sent on alarm to all recipients, distribution list, or email-to-SMS
 - SNMP Traps: Multiple community strings
 - Relay: 1 Form C summary relay output

- Web Interface Login Security:
 - 8 password read only, 8 password read/write
- Communication Port:
 - Ethernet: 10/100 BaseT, RJ45 connector; 500VAC RMS isolation; DHCP enabled; Static IP-addressable
- Protocols:
 - TCP/IP: ARP; DNS; UDP; DHCP; ICMP
 - HTML: Supports multiple simultaneous connections
 - SMTP (email): SMTP authentication; SMTP relay; supports SSL; up to 8 recipients
 - Modbus TCP/IP: Modbus slave; TCP/IP transmission protocol
 - SNMP: V1; V2C MIB-2 compliant; NMS manageable with Get and Traps; V2C Get, V2C and V1 Traps
 - NTP: Custom server settings
- Logging: Logs 50 most recent alarm and return to normal events with date/time stamp.
- Trending: Records up to 86,400 points of sensor data. Sample interval set from 1 second to 1 day. CSV downloadable.
- Operating Environment
 - Temperature: -40°F to 185°F (-40°C to 85°C)
 - Humidity: 0% to 100% RH, non-condensing
 - Altitude: 15,000ft (4,572m) max.
 - Storage Environment: -40°F to 185°F (-40°C to 85°C)
- Dimensions: 1.00"H x 5.63"W x 2.63"D (25mm x 143mmW x 67mmD)
- Weight: 10.1 oz. (287g)
- Mounting: Stand alone; keyholes included for wall mount; rack-mount bracket available



Rack-Mount Bracket

- Holds (2) RIM-750 units
- 1U x 19" EIA x 3"D (76 mm)
- Black Finish

Part Number	Description	Shipping Weight lb (kg)
60107-001	Rack-Mount Bracket, 1U x 19" EIA x 3"D (76 mm)	1 (0.5)



60114-002 shown

Sensors

Part Number	Sensors for RIM-750	Shipping Weight lb (kg)
Temperature and Humidity Sensors		
60108-001	Temperature Sensor, RJ11, 25'L (7.6 m) cord	1 (0.5)
60108-002	Temperature and Humidity Sensor, RJ11, 25'L (7.6 m) cord	1 (0.5)
Digital Input, Sensors		
60113-002	Smoke Detector, Power Supply included	2 (0.9)
60114-002	Motion Detector, Power Supply included	2 (0.9)
60115-001	Magnetic Door Sensor	1 (0.5)
Leak Detection, Sensors		
60116-001	Leak Detection Lead Cable, 15'L (4.57 m) and End of Line Terminator*	1 (0.5)
60109-003	Leak Detection Sensor Rope, 10 ft L (3.0 m)	1 (0.5)
60109-004	Leak Detection Sensor Rope, 25 ft L (7.6 m)	1 (0.5)
60109-005	Leak Detection Sensor Rope, 50 ft L (15.2 m)	3 (1.4)
60109-006	J-Clips, to install Sensor Rope, Pack of 10	1 (0.5)
60109-007	J-Clips, to install Sensor Rope, Pack of 50	1 (0.5)

Note: The RIM-750 has four connections for temperature and humidity sensors, eight connections for digital input sensor, and one built-in single-zone leak detection controller that supports up to 200 feet (60 m) of Sensor Rope, one Leak Detection Lead Cable is required to attach Sensor Rope(s) to the RIM-750. Connect Sensor Ropes end-to-end to extend length, as required. Do not exceed 200 feet (60 m).

Alternately, you can use up to four Leak Spot Detectors, which attach to one of the eight digital inputs on the RIM-750. When using a mix of Sensor Rope and Leak Spot Detectors, each Leak Spot Detector reduces the total footage of Sensor Rope supported by the built-in single-zone controller by 50 feet (15.2 m). For example, if you use two leak Spot Detectors, the RIM-750 will only support up to 100 feet (30 m) of Sensor Rope. Smoke Detector and Motion Sensor require an external power source (a VAC power supply is included).



RFID Electronic Lock Kit

The Electronic Lock Kit solution can be preinstalled in CPI cabinets and features swinghandles with integrated dual-frequency card reader technology. Audit trail capability allows for enhanced regulatory compliance.

Features:

- Integrated RFID Card Reader – Separate lock options recognize existing employee 125 kHz or 13.56 MHz RFID cards, including HID, iClass®, MIFARE® and DESFire technologies
- Future-proof Design – Modular reader allows the use of the same swinghandle as card technologies evolve
- Flexible Management – Multiple methods of integration: through eConnect PDUs, networked controller or building security access control system
- Regulatory Compliance – Allows audit trail to be maintained for every access attempt within DCIM software or access control systems in order to comply with HIPAA, PCI DSS, GDPR, FISMA, Saas SOC 2®, HITECH and more
- Quick Deployment – Locks can be factory-preinstalled into CPI TeraFrame and GlobalFrame cabinets
- eConnect Integration – Eliminates the need for a separate IP address or a separate source of power for the lock. Saves significant deployment costs normally associated with wiring the locks to security panels
- Remote Access Control – Ability to remotely open/close doors allows administrators to provide access to contractors without badges
- Centralized Authentication – Ability to use the permissions set within RADIUS server to provide higher levels of security



eConnect RFID Electronic Lock Kit

eConnect RFID Electronic Lock Kit is a front and rear single-factor, 12V lock solution that is activated by RFID cards and fully integrates into networked eConnect PDUs (P/N EX-XXXX only), so that no additional appliance or external software are required. Available on vertical Monitored, Monitored Pro, Switched and Switched Pro PDUs.

Kit includes:

- 12 Volt locks
- Front and rear swinghandles
- 3 door sensors (front and rear doors)
- 2 wiring harnesses (for front and rear connection)
- 2 mechanical override keys

Part Number	Description	Shipping Weight lb (kg)
14666-001	eConnect® RFID Electronic Lock Kit	3 (1.4)
14665-001	USB Temperature and Humidity Sensor	1 (0.5)
36651-001	Wire Harness Kit	1 (0.5)
36652-001	Door Sensor Kit	1 (0.5)
36653-001	RF IDEas EAC Smart Card Reader	1 (0.5)
36654-001	RFID Cards, Pack of 20	1 (0.5)

Note: Use this kit with eConnect PDUs with eConnect Controller 4 (MCM4) only.



Networked RFID Electronic Lock Kit

Networked RFID Electronic Lock Kit provides a networked electronic lock solution for physical security of data center cabinets. Secure Array IP Consolidation technology connects up to 32 controllers (32 cabinets) under one IP address, providing significant savings in networking costs. The controller module features a Gigabit Ethernet port and a built-in web interface.

Kit includes:

- 12 Volt locks
- Capability to integrate with USB Temperature and Humidity Sensor
- Front and rear swinghandles
- 3 door sensors (front and rear doors)
- 2 wiring harnesses (for front and rear connection)
- 2 mechanical override keys

Part Number	Description	Shipping Weight lb (kg)
14667-001	Networked RFID Electronic Lock Kit*	7 (3.2)
14665-001	USB Temperature and Humidity Sensor	1 (0.5)
36653-001	RF IDeas EAC Smart Card Reader	1 (0.5)
36654-001	RFID Cards, Pack of 20	1 (0.5)

Note: Use with 125 kHz CSN and/or 13.56 MHz UID RFID cards. Does not support PACS smart cards.



Security System RFID Electronic Lock Kit

Security System RFID Electronic Lock solution that integrates with Wiegand-based security panels. It supports connection for two separate channels for independent system control.

Kit includes:

- Front and rear swinghandles
- 3 door sensors (front and rear doors)
- 2 wiring harnesses (for front and rear connection)
- 2 mechanical override keys

Part Number	Description	Shipping Weight lb (kg)
14668-001	Security System RFID Electronic Lock Kit	3 (1.4)
36653-001	RF IDeas EAC Smart Card Reader	1 (0.5)
36654-001	RFID Cards, Pack of 20	1 (0.5)

Note: Use with 125 kHz CSN and/or 13.56 MHz UID RFID cards. Does not support PACS smart cards.



Available in U.S. & Canada only

Features:

Compact Design—This compact design will easily fit where a conventional UPS will not

Long-Life Battery—Lithium iron phosphate batteries provide protection for up to 8-10 years or 2000 discharges

Highest Efficiency—operates at up to 98% efficiency, saving utility costs and reducing heat output

High Temperature Tolerance—Lithium Ion battery technology allows continuous operation at up to 104°F (40°C) without reduction in battery life

Auto restart—after full battery discharge, automatically restarts when utility power returns

Lithium Ion Standby UPS, 350VA-600VA

This compact design is excellent for use in wall-mount networking and computer equipment cabinets when providing protection to network switches, industrial computers, automation systems, programmable logic controllers (PLCs), video walls, kiosks, and point-of-sale (POS) equipment.

- Available models: 350VA/200W, 600VA/360W
- Surface mount to wall, ceiling, under counters or inside enclosure
- UL, CE, RoHS, TAA compliant
- 6 years electronics, 6 years battery warranty (USA and Canada)

Specifications:

- Standby UPS with lithium iron phosphate batteries
- For indoor use in environmentally controlled areas or within environmental enclosures that maintain Operating Conditions
- Power Capacity: Specific to UPS
- Power Input:
 - Alternating current, 50/60 Hz autosenesing
 - Voltage, 120 VAC nominal or 200-240 VAC (see ordering table)
- Power Output:
 - Voltage, 120 VAC nominal or 200-240 VAC (see ordering table)
 - Waveform: Sine wave (normal), simulated sine wave (battery mode)
 - Frequency: 50/60 Hz
 - Surge suppression: 300 joules
 - Transfer time: 2-6 ms (typical)
- Battery:
 - Cell type: Lithium Iron Phosphate (LiFePO4)
 - Cell configuration: Specific to UPS
 - LS350x: (8) LiFePO4 18650 cells, 2400 mAh
 - LS600x: (16) LiFePO4 18650 cells, 4400 mAh
- Physical:
 - Flange mount on a wall, ceiling or flat surface
 - Dimensions: Specific to UPS
 - LS350x: 1.25"H x 6.9"W x 8.5"D (32 mm x 175 mm x 216 mm)
 - LS600x: 1.6"H x 7.3"W x 10.8"D (40 mm x 185 mm x 275 mm)
 - Surface-mount brackets add .6" (15 mm) to width on each side
 - Weight: Specific to UPS
 - LS350x: 3.4 lb (1.5 kg)
 - LS600x: 4.7 lb (2.1 kg)
 - Line cord: Specific to UPS (see ordering table)
 - Receptacles: Specific to UPS (see ordering table)
- Operating Conditions:
 - Temperature: 32-104°F (0-40°C)
 - Humidity: 0-90%
 - Elevation: 0-11,500' above sea level
- Approvals:
 - 120 Volt models: UL-177B, cTUVus, FCC, RoHS, TAA compliant
 - 200-240 Volt models: CE, RoHS, TAA Compliant
- Communications Interface:
 - Specific to UPS:
 - LS350x: USB interface with cable and software
 - LS600x: RS-232 port
- Included in Box:
 - ViewPower software, user manual, line cord (120 VAC models)

Lithium Ion Standby UPS, 350VA-600VA:

Part Number	Capacity VA	Capacity W	Input Plug*	Output Receptacles	Runtime 100% Load	Runtime 50% Load	External Battery Option
120 Volt							
LS350A	350	200	C14 Inlet to 5-15P	(3) 5-15R	6	14	No
LS600A	600	360	C14 Inlet to 5-15P	(3) 5-15R	6	14	No
200-240 Volt							
LS350B	350	200	C14 Inlet (no cord)	(2) C13	6	14	No
LS600B	600	360	C14 Inlet (no cord)	(2) C13	6	14	No

*On 120 Volt models, included line cord is 3' (0.9 m) long. On 200-240 Volt models, order a line cord separately. C13 to required plug.

Battery Runtimes:

Estimated Runtimes On Internal Batteries (mins)										
System Load (W)	20	40	80	120	160	200	240	280	320	360
LS350x	72	35	17	11	9	7	N/A	N/A	N/A	N/A
LS600x	161	79	35	23	17	14	11	9	8	6

Note: Runtimes are shown in minutes and will vary based on battery condition, age, cycles and ambient temperature



Available in U.S. & Canada only

Features:

Pure Sine Wave Line-Interactive Conversion—

Provides robust power protection against blackouts, brownouts and voltage surges

99% efficient operation—high efficiency ECO mode lowers energy consumption

Auto restart—Automatically restarts when utility power returns after full battery discharge

Smart LCD display—Vital monitoring and precise information from the front panel

Programmable receptacle group—maximize uptime for critical loads and equipment by shedding less critical loads

Temperature compensation—temperature compensated charging to prolong battery life and help reduce replacement costs

Hot swappable battery—easy to replace without interrupting the load

Maintenance bypass—an optional maintenance bypass distribution module enables the UPS to be replaced or serviced without interruption of power to critical loads

Extended battery runtimes—optional matching battery modules available for extended runtimes

Lead Acid Line-Interactive UPS, 800VA–5000VA

Reliable and economical backup power protection for servers and network applications.

- Available models: 800VA, 1100VA, 1500VA, 2000VA, 2200VA, 3000VA, 5000VA
- Tower, two-post, and four-post rack mounting configurations
- UL, CE, RoHS, TAA compliant
- 3 years electronics, 3 years battery warranty (USA and Canada)

Specifications:

- Pure sine wave Line-Interactive UPS with lead acid batteries
- For indoor use in environmentally controlled areas or within environmental enclosures that maintain Operating Conditions
- Power Capacity: Specific to UPS
- Power Input:
 - Alternating current, 50/60 Hz autosensting
 - Voltage, varies per model (see ordering table)
 - 120 VAC models support 120 VAC nominal input, -32% to +27% range without use of battery
 - 200-240 VAC models support 208/220/230/240 VAC nominal input, 162-290 VAC range
- Power Output:
 - Voltage, varies per model (see ordering table)
 - 120 Volt models support 120 VAC nominal with 100/115/127 VAC selectable output
 - 200-240 Volt models support 230 VAC nominal with 208/220/230/240 VAC selectable output.
 - Waveform: Pure sine wave
 - Transfer time (typical): 2-6 ms
 - Efficiency: Up to 99% ECO mode, 95% buck and boost mode
 - Harmonic distorton: 2% @ 100% linear load; 5% @ 100% non-linear load
- Battery:
 - Battery Chemistry: Sealed, maintenance-free lead acid
 - Battery Size: Specific to UPS
 - VL800x: (2) 12V 7AH
 - VL1100x: (2) 12V 9AH
 - VL1500x: (4) 12V 7AH
 - VL2000x: (4) 12V 9AH
 - VL2200x: (6) 12V 7AH
 - VL3000x: (6) 12V 9AH
 - VL5000x: (6) 12V 580W at 5 min
 - Charger current: 1.5A max
 - Recharge Time: 4 hours to 90%
- Rack-Mount Spaces: 2U, includes mounting bracket
- Dimensions: Specific to UPS
 - VL800x: 3.5" H x 17.2" W x 15.1" D (89 mm x 437 mm x 384 mm)
 - VL1100x: 3.5" H x 17.2" W x 15.1" D (89 mm x 437 mm x 384 mm)
 - VL1500x: 3.5" H x 17.2" W x 18.9" D (89 mm x 437 mm x 480 mm)
 - VL2000x: 3.5" H x 17.2" W x 18.9" D (89 mm x 437 mm x 480 mm)
 - VL2200x: 3.5" H x 17.2" W x 23.6" D (89 mm x 437 mm x 600 mm)
 - VL3000x: 3.5" H x 17.2" W x 23.6" D (89 mm x 437 mm x 600 mm)
 - VL5000x: 3.5" H x 17.2" W x 23.6" D (89 mm x 437 mm x 600 mm)
 - Add 1" (25.4 mm) to front for bezel; extends in front of the equipment mounting rails
- Weight: Specific to UPS
 - VL800x: 29.3 lb (13.3 kg)
 - VL1100x: 30.5 lb (13.8 kg)
 - VL1500x: 44.7 lb (20.3 kg)
 - VL2000x: 47.4 lb (21.5 kg)
 - VL2200x: 61.7 lb (27.9 kg)
 - VL3000x: 67.1 lb (30.4 kg)
 - VL5000x: 78.5 lb (35.6 kg)

Specifications (continued):

- Line cord: Specific to UPS (see ordering table)
- Receptacles: Specific to UPS (see ordering table)
- Optional Battery Packs
 - Rack-Mount Spaces: 2U, includes mounting brackets
- Dimensions: Specific to Battery Pack:
 - VXBP1: 3.5"H x 17.2"W x 18.9"D (89 mm x 437 mm x 480 mm)
 - VXBP2: 3.5"H x 17.2"W x 23.6"D (89 mm x 437 mm x 600 mm)
 - VXBP3: 3.5"H x 17.2"W x 23.6"D (89 mm x 437 mm x 600 mm)
- Weight: Specific to Battery Pack:
 - VXBP1: 74.6 lb (33.8 kg)
 - VXBP2: 104.4 lb (47.4 kg)
 - VXBP3: 110.4 lb (50.1 kg)
- Battery: Specific to Battery Pack:
 - VXBP1: (8) 12V 9AH / 48VDC
 - VXBP2: (12) 12V 9AH / 72VDC
 - VXBP3: (12) 12V 580W at 5 min / 72VDC

- Operating Conditions:
 - Temperature: 32-104°F (0-40°C)
 - Audible noise: <45dBA
 - Elevation: 0-11,500' (0-3500 m) above sea level
- Approvals:
 - 120 Volt models: UL, cUL, RoHS, TAA Compliant
 - 200-240 Volt models: CE, RoHS, TAA Compliant
- Warranty:
 - 3 years electronics, 3 years battery warranty (USA and Canada)
- Communications Interface:
 - RS232, USB, EPO, intelligent slot for optional card (Web/SNMP)
- Included in Box:
 - ViewPower software, user manual, horizontal brackets, and tower pedestals

Lead Acid Line-Interactive UPS, 800VA–5000VA:

VL3000A-1 Rear

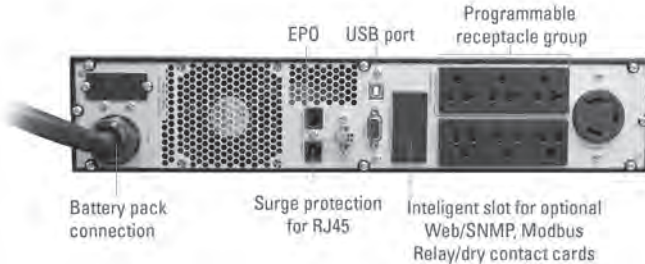

VL3000B Rear

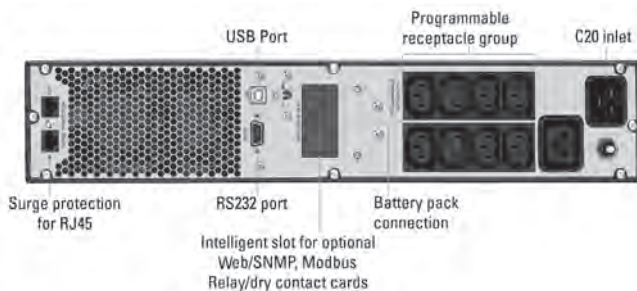

Lead Acid Line-Interactive UPS, 800VA–5000VA:

Part Number	Capacity VA	Capacity W	Input Plug*	Output Receptacles	Runtime 100% Load	Runtime 50% Load	External Battery Option	Bypass Distribution Module Compatibility
120 Volt								
VL800A	800	720	5-15P	(8) 5-15R	4	11	No	BDM1A
VL1100A	1100	990	5-15P	(8) 5-15R	3	11	No	BDM1A
VL1500A	1500	1350	5-15P	(8) 5-15R	4	12	VXBP1	BDM1A
VL2000A	2000	1800	5-20P	(8) 5-20R	4	12	VXBP1	BDM1B
VL2200A	2200	2000	5-20P	(8) 5-20R	4	12	VXBP2	BDM1B
VL3000A	3000	2700	L5-30P	(8) 5-20R	4	12	VXBP2	BDM1D
VL3000A-1	3000	2700	L5-30P	(1) L5-30R + (6) 5-20R	4	12	VXBP2	BDM1D
200-240 Volt*								
VL3000B	3000	2700	C19 Inlet to L6-20P	(1) C19 + (8) C13	3	8	VXBP2	BDM1C
VL5000B	5000	4500	L6-30P	(1) L6-30R + (4) C19	2	5	VXBP3	No
VL5000B-1	5000	4500	L6-30P	(2) L6-30R + (2) L6-20R + (1) C19	3	8	VXBP3	No

**For 120 VAC models, Voltage input is 120 nominal, -32% to +27% range without use of battery. Voltage output is 120 VAC nominal with 100/115/127 VAC selectable output. Line cord is 6' (1.8 m) long.

*For 200-240V models, voltage input is 208/220/230/240 VAC nominal, 162-290 VAC range. Voltage output is 230 VAC nominal with 208/220/230/240 VAC selectable output.

Line cord on VL3000B is 8' (2.4 m) long. Other line cords are 6' (1.8 m) long.

Battery Runtimes:

Battery Runtimes as a percentage of full load														
UPS P/N	Capacity (Watts)	Internal Batteries Only				With (1) Battery Pack				With (2) Battery Packs				Battery P/N
		25%	50%	75%	100%	25%	50%	75%	100%	25%	50%	75%	100%	
VL800A	720	29	11	6	4	N/A	N/A	N/A	N/A	N/A	N/A	N/A	N/A	N/A
VL1100A	990	26	11	5	3	N/A	N/A	N/A	N/A	N/A	N/A	N/A	N/A	N/A
VL1500A	1350	31	12	6	4	124	53	31	22	216	102	61	42	VXBP1
VL2000A	1800	30	12	6	4	119	50	30	20	211	97	58	40	VXBP1
VL2200A	2000	32	12	6	4	125	54	32	22	219	104	62	43	VXBP2
VL3000A	2700	30	12	6	4	119	50	30	20	211	97	58	40	VXBP2
VL3000A-1	2700	30	12	6	4	119	50	30	20	211	97	58	40	VXBP2
VL3000B	2700	13	8	5	3	56	34	24	20	107	66	47	38	VXBP3
VL5000B	4500	10	5	3	2	38	24	18	14	71	45	33	27	VXBP3
VL5000B-1	4500	10	5	3	2	38	24	18	14	71	45	33	27	VXBP3

Battery runtimes shown in minutes and will vary based on battery condition, age, cycles and ambient temperature. Maximum of two external battery packs per UPS.



Available in U.S. & Canada only

Features:

6-Year Full Warranty—industry-leading coverage for both Lithium Ion batteries and UPS electronics.

Double-Conversion Online—Provides the most robust power protection against blackouts, brownouts, voltage surges, frequency variation and harmonic distortion

Longer Runtimes—Internal runtimes up to 5 times longer than lead-acid UPS

Longer Lifespan—Up to 2000 full discharge cycles. Up to 10 times more than lead-acid UPS

Quick Recharge—90 minutes to 90% full charge with powerful 8 Amp charger

Lower Weight—25% less heavy than typical lead-acid UPS

Battery Management System—Ensures cell voltage balancing, current sharing and protection for over-charge and over-discharge

Maintenance bypass—optional bypass distribution module enables the UPS to be replaced or serviced without power interruption

Lithium Ion Online UPS,1500VA–3000VA

Provides more than twice the life, higher temperature, tolerance, longer runtime, and faster recharge when compared to typical lead-acid battery solutions. double-conversion Online technology makes this UPS ideal for protection of network, server, edge, light industrial and distributed IT applications.

- Available models: 1500VA/1350W, 2000VA/1800W, 3000VA/2700W
- Tower, two-post, and four-post rack mounting configurations
- UL, cUL, RoHS, FCC A, UN38.3 for battery transportation
- Hot swappable internal lithium ion battery pack

Specifications:

- Double-conversion online UPS with lithium iron phosphate battery
- For indoor use in environmentally controlled areas or within environmental enclosures that maintain Operating Conditions
- Power Capacity: Specific to UPS
- Power Input:
 - Alternating current, 50/60 Hz autosensing
 - Voltage, varies per model (see ordering table)
 - 120 Volt models support 55-150 VAC input depending on load level
 - 200-240 Volt models support 110-330 VAC input depending on load level
- Power Output:
 - Voltage, varies per model (see ordering table)
 - 120 Volt models support 100/110/115/120/127 VAC selectable output
 - 200-240 Volt models support 200/208/220/230/240 VAC selectable output
 - Waveform: Pure sine wave: <=2% THD (linear load), <=4% THD (non-linear load)
 - Frequency: 50/60 Hz ± 0.1 Hz
 - Efficiency: Up to 98% efficiency
 - Overload Capacity: Online mode: >110% & ≤ 130% for 5 min; >130% & ≤140% for 30 sec; >140% for 1.5 sec
- Battery:
 - Cell type: Lithium Iron Phosphate, LFP26650 2600 mAh
 - Cell configuration: Specific to UPS
 - LD1500x: (1) 15S2P
 - LD2000x: (2) 15S2P
 - LD3000x: (3) 24S1P
 - Charger Voltage: Specific to UPS
 - LD1500x: 52.2 VDC
 - LD2000x: 52.2 VDC
 - LD3000x: 84.0 VDC
 - Charger current: 1/2/4/6/8 Amp (4 Amp default), adjustable through LCD
 - Recharge Time: 1.5 hours to 90% charge
- Rack-Mount Spaces: 2U, includes mounting bracket
- Dimensions: Specific to UPS
 - LD1500x: 3.5"H x 17.2"W x 15.1"D (89 mm x 437 mm x 384 mm)
 - LD2000x: 3.5"H x 17.2"W x 19.0"D (89 mm x 437 mm x 482 mm)
 - LD3000x: 3.5"H x 17.2"W x 23.8"D (89 mm x 437 mm x 605 mm)
 - Add 1" (25.4 mm) to front for bezel. Bezel extends in front of the equipment mounting rails.
- Weight: Specific to UPS
 - LD1500x: 25.6 lb (11.5 kg)
 - LD2000x: 33.5 lb (15.2 kg)
 - LD3000x: 45.2 lb (20.5 kg)
- Line cord: Specific to UPS (see ordering table)
- Receptacles: Specific to UPS (see ordering table)- VL5000x: 78.5 lb (35.6 kg)
- Operating Conditions:
 - Temperature: 32-104°F (0-40°C)
 - Elevation: 0-11,500' (0-3500 m) above sea level

Specifications (continued):

- Approvals:
 - 120 Volt models: UL, cUL, RoHS, FCC Class A and TAA Compliant, battery pack comply to UL1973, UN38.3 for battery transport
 - 200-240 Volt models: CE, RoHS and TAA Compliant, battery packs comply to UL1973, UN38.3 for battery transportation
- Warranty:
 - 6 years electronics, 6 years battery warranty (USA and Canada)
- Communications Interface:
 - RS232, USB, EPO, intelligent slot for optional card (Web/SNMP)
- Included in Box:
 - ViewPower software, user manual, horizontal brackets, and tower pedestals



Hot Swappable Battery

Lithium Ion Online UPS,1500VA–3000VA:

LD1500A / LD2000A Rear View



LD3000B Rear View



Lithium Ion Online UPS,1500VA–3000VA:

Part Number	Capacity VA	Capacity W	Input Plug*	Output Receptacles	Runtime 100% Load	Runtime 50% Load	Bypass Distribution Module Compatibility
120 Volt**							
LD1500A	1500	1350	5-15P	(8) 5-15R	8	19	BDM1A
LD2000A	2000	1800	5-20P	(8) 5-20R	14	30	BDM1B
LD3000A	3000	2700	L5-30P	(1) L5-30P + (6) 5-20R	11	23	BDM1D
LD1500A	1500	1350	5-15P	(8) 5-15R	8	19	BDM1A
LD2000A	2000	1800	5-20P	(8) 5-20R	14	30	BDM1B
LD3000A	3000	2700	L5-30P	(1) L5-30P + (6) 5-20R	11	23	BDM1D
200-240 Volt*							
LD1500B	1500	1350	C14 Inlet to L6-20P	(8) C13	8	19	BDM1C
LD2000B	2000	1800	C20 Inlet to L6-20P	(8) C13	14	30	BDM1C
LD3000B	3000	2700	C20 Inlet to L6-20P	(1) C19+ (8) C13	11	23	BDM1C

**Voltage input: 55-150 VAC (depending on load level)

**Voltage output: 100/110/115/120/127 VAC selectable. Derate capacity to 80% when output voltage is adjusted to 100 VAC.

**Line cord is 6' (1.8 m) long.

*Voltage input 110-330 VAC (depending on load level)

*Voltage output: 200/208/220/230/240 VAC selectable. Derate capacity to 80% when output voltage is adjusted to 200 or 208 VAC.

*Line cord is 8' (2.4 m) long.

Battery Runtimes:

Estimated Runtimes on Internal Batteries (mins)										
Percentage Load										
UPS P/N	10%	20%	30%	40%	50%	60%	70%	80%	90%	100%
LD1500X	111	54	34	25	19	16	13	11	9	8
LD2000X	163	79	51	38	30	24	21	18	16	14
LD3000X	127	62	40	29	23	19	16	14	12	11

Runtimes are shown in minutes and will vary based on battery condition, age, cycles and ambient temperature.



Available in U.S. & Canada only

Features:

Double-Conversion Online—Provides the most robust power protection against blackouts, brownouts, voltage surges, frequency variation and harmonic distortion

High output power factor—provides near unity output power factor rating (2U units)

Efficient operation—operation—up to 98% ECO mode efficiency lowers energy consumption

Charging current—1/2/4/6/8/12A, adjustable from LCD display. Optimize charging for most battery solutions (2U units only)

Fast recharge—up to 95% battery charge in just 3 hours (2U units)

Multiple communications capability—RS-232, USB, and optional Web/SNMP communications card

Programmable receptacles—remote on/off control (2U only) to extend runtimes to critical pieces of equipment in the event of a utility power outage

Extended battery runtimes—optional matching battery modules available for extended runtimes

Lead Acid Online UPS, 1000VA-3000VA

Reliable and economical backup power protection for servers and network applications.

- Available models: 1000VA, 1500VA, 2000VA, 3000VA
- Tower, wall, two-post, and four-post rack mounting configurations
- UL, cUL, CE, RoHS, FCC A, FCC B, TAA compliant (UPS only)
- Hot swappable battery design
- 3 years electronics, 3 years battery warranty (USA and Canada)

Specifications:

- Double-conversion online UPS with lead acid battery
- For indoor use in environmentally controlled areas or within environmental enclosures that maintain Operating Conditions
- Power Capacity: Specific to UPS
- Power Input:
 - Alternating current, 50/60 Hz autosenesing
 - Voltage, varies per model (see ordering table)
 - 120 VAC models support 55-150 VAC input depending on load level
 - 200-240 VAC models support 208/220/230/240 VAC input depending on load level
- Power Output:
 - Voltage, varies per model (see ordering table)
 - 120 Volt models support 120 VAC nominal. 2U models support 100/110/115/127 VAC selectable output. Capacities are based on highest selectable voltage. Some models derate at lower voltages.
 - 200-240 Volt models support 230 VAC nominal. 2U models support 200/208/220/230/240 VAC selectable output. Capacities derates to 90% at 208 Volt.
 - Waveform: Pure sine wave:
 - 1U: <3% THD (linear load), <5% THD (non-linear load);
 - 2U: <2% THD (linear load), <4% THD (non-linear load)
 - Frequency:
 - 1U: 50/60 Hz ± 0.3 Hz
 - 2U: 50/60 Hz ± 0.1 Hz
 - Efficiency: Up to 98% efficiency
 - Overload Capacity: Online mode
 - 1U: > 105% & ≤ 130% for 2 min; >130% & ≤200% for 10 sec;
 - >200% for 250 ms sec
 - 2U: >110% & ≤ 130% for 5 min; >130% & ≤140% for 30 sec; >140% for 1.5 sec
- Battery:
 - Battery Chemistry: Sealed, maintenance-free lead acid
 - Battery Size: Specific to UPS
 - VD1000x1U: (4) 6V 290W
 - VD1000x: (2) 12V 9AH
 - VD1500x: (3) 12V 9AH
 - VD2000x: (4) 12V 9AH
 - VD3000x: (6) 12V 9AH
 - Charger Voltage: Specific to UPS
 - VD1000x1U: 27.4 VDC
 - VD1000x: 27.4 VDC
 - VD1500x: 41.1 VDC
 - VD2000x: 58.8 VDC
 - VD3000x: 82.1 VDC
 - Charger current:
 - 1U: 1A default
 - 2U: 2A default, max 8A, adjustable through LCD
 - Recharge Time:
 - 1U: < 9 hours to 90%
 - 2U: < 3 hours to 95% with 2A charger current

Specifications (continued):

- Rack-Mount Spaces: 1U or 2U, includes mounting brackets
- Dimensions: Specific to UPS
 - 1U:
 - VD1000x1U: 1.7"H x 17.2"W x 17.8"D (43 mm x 437 mm x 452 mm)
 - 2U:
 - VD1000x: 3.5"H x 17.2"W x 15.1"D (89 mm x 437 mm x 384 mm)
 - VD1500x: 3.5"H x 17.2"W x 15.1"D (89 mm x 437 mm x 384 mm)
 - VD2000x: 3.5"H x 17.2"W x 19.0"D (89 mm x 437 mm x 483 mm)
 - VD3000x: 3.5"H x 17.2"W x 23.8"D (89 mm x 437 mm x 605 mm)
- Add 1" (25 mm) to front for bezel. Bezel extends in front of the equipment mounting rails.
- Weight: Specific to UPS
 - VD1000x1U: 28.0 lb (12.7 kg)
 - VD1000x: 25.6 lb (11.6 kg)
 - VD1500x: 34.2 lb (15.5 kg)
 - VD2000x: 43.0 lb (19.5 kg)
 - VD3000x: 60.6 lb (27.5 kg)

- Line cord: Specific to UPS (see ordering table)
- Receptacles: Specific to UPS (see ordering table)
- Operating Conditions:
 - Temperature: 32-104°F (0-40°C)
 - Elevation: 0-11,500' (0-3500 m) above sea level
- Approvals:
 - 120 Volt models: UL, cUL, RoHS, FCC Class B (VD1000x, VD1500x), FCC Class A (VD1000x1U, VD2000x, VD3000x), TAA compliant (UPS only)
 - 200-240 Volt models: CE, RoHS, TAA compliant (UPS only)
- Warranty:
 - 3 years electronics, 3 years battery warranty (USA and Canada)
- Communications Interface:
 - RS-232 (2U only), USB, EPO, intelligent slot for optional card (Web/SNMP)
- Included in Box:
 - ViewPower software, user manual, horizontal brackets, and tower pedestals

Lead Acid Online UPS, 1000VA-3000VA:

UPS Rear View VD1000A1U (top) & VD1000A (bottom)

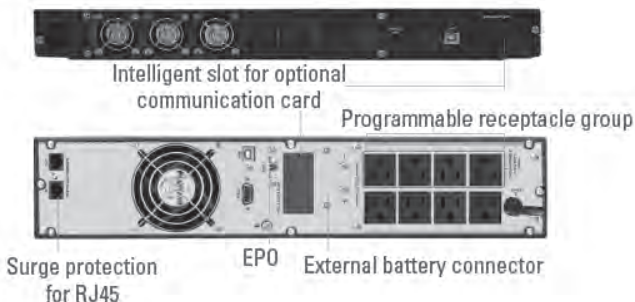

UPS Rear View of VD1000B1U (top) and VD3000B (bottom)

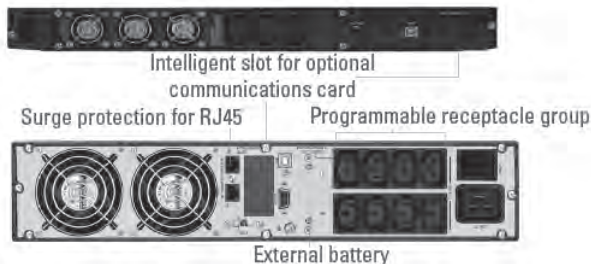

Lead Acid Online UPS, 1000VA-3000VA:

Part Number	Capacity VA	Capacity W	Input Plug*	Output Receptacles	Runtime 100% Load	Runtime 50% Load	External Battery Option	Bypass Distribution Module Compatibility
120 Volt**								
VD1000A1U	1000	800	C14 Inlet to 5-15P	(3) 5-15R	8	20	No	BDM1A
VD1000A	1000	1000	5-15P	(8) 5-15R	3	6	No	BDM1A
VD1500A	1500	1450	5-15P	(8) 5-15R	3	10	VXBP4 or VXBP5	BDM1A
VD2000A	2000	1930	5-20P	(8) 5-20R	3	10	VXBP6	BDM1B
VD3000A	3000	2880	L5-30P	(1) L5-30R + (6) 5-20R	3	10	VXBP7	BDM1D
200-240 Volt*								
VD1000B1U	1000	800	C14 Inlet to L6-20P	(3) C13	8	20	No	BDM1C
VD1500B	1500	1450	C14 Inlet to L6-20P	(8) C13	3	10	VXBP4 or VXBP5	BDM1C
VD2000B	2000	1930	C20 Inlet to L6-20P	(8) C13	3	10	VXBP6	BDM1C
VD3000B	3000	2880	C20 Inlet to L6-20P	(1) C19 + (8) C13	3	10	VXBP7	BDM1C

Notes:

*For 120 VAC models, Voltage input range is 55-150 VAC (depending on load level). Voltage output is 120 VAC nominal. 2U models support 100/110/115/127 VAC selectable output. Capacities are based on highest selectable voltage. Some models derate at lower voltages.

**For 200-240 VAC models, Voltage input is 208/220/230/240 VAC (depending on load level). Voltage output is 230 VAC nominal. 2U models support 200/208/220/230/240 VAC selectable output.

Capacity derates to 90% at 208 Volts.

Line cord on VD1000A1U is 5' (1.5 m) long, Line cord on other 120 VAC models are 6' (1.8 m) long.

Line cords on 200-240 VAC models are 8' (2.4 m) long.

Battery Runtimes:

Battery Runtimes as a Percentage of Full Load																		
UPS P/N	Capacity (Watts)	Internal Batteries Only		(1) Battery Pack		(2) Battery Packs		(3) Battery Packs		(4) Battery Packs		(5) Battery Packs		(6) Battery Packs		(7) Battery Packs		Battery P/N
		50%	100%	50%	100%	50%	100%	50%	100%	50%	100%	50%	100%	50%	100%	50%	100%	
VD1000A1U	800	20	8	N/A	N/A	N/A	N/A	N/A	N/A	N/A	N/A	N/A	N/A	N/A	N/A	N/A	N/A	N/A
VD1000A	1000	6	3	N/A	N/A	N/A	N/A	N/A	N/A	N/A	N/A	N/A	N/A	N/A	N/A	N/A	N/A	N/A
VD1500A	1450	10	3	42	17	84	33	120	51	157	72	199	93	244	112	289	128	VXBP4
VD1500A	1450	10	3	84	33	157	72	244	122	339	146	N/A	N/A	N/A	N/A	N/A	N/A	VXBP5
VD2000A	1930	10	3	42	17	84	33	121	51	157	72	200	93	244	112	289	128	VXBP6
VD3000A	2880	10	3	42	17	84	33	121	52	158	73	201	94	246	112	292	129	VXBP7
VD1000B1U	800	20	8	N/A	N/A	N/A	N/A	N/A	N/A	N/A	N/A	N/A	N/A	N/A	N/A	N/A	N/A	N/A
VD1500B	1450	10	3	42	17	84	33	120	51	157	72	199	93	244	112	289	128	VXBP4
VD1500B	1450	10	3	84	33	157	72	244	112	339	146	449	189	523	233	N/A	N/A	VXBP5
VD2000B	1930	10	3	42	17	84	33	121	51	157	72	200	93	244	112	290	128	VXBP6
VD3000B	2880	10	3	42	17	84	33	121	52	158	73	201	94	246	112	292	129	VXBP7

Runtimes are shown in minutes and will vary based on battery condition, age, cycles and ambient temperature. Maximum of seven battery packs with Models VD1500x, VD2000x and VD3000x. Note N/A indicates battery pack limit for various UPS and battery pack combinations.



Available in U.S. & Canada only

Features:

Double-Conversion Online—Provides the most robust power protection against blackouts, brownouts, voltage surges, frequency variation and harmonic distortion

Unity output power factor—provide more real capacity for high density loads

Efficient operation—operation—up to 98% ECO mode efficiency lowers energy consumption

Hot swappable battery—optional battery packs are easy to replace without interrupting the load

Multiple communications capability—RS-232, USB, and optional Web/SNMP communications card

Maintenance bypass—optional bypass module enables the UPS to be replaced or serviced without interruption of power to critical loads

Extended battery runtimes—optional matching battery modules available for extended runtimes

Isolation transformer—optional transformer provides 240/120 or 208/120V output

Lead Acid Online UPS, 5000VA-10,000 VA

Reliable and economical backup power protection for servers and network applications.

- Available models: 5kVA/5kW, 6kVA/6kW, 10kVA/10kW
- Tower, wall, two-post, and four-post rack mounting configurations
- UL 1778, cUL, FCC, RoHS, CE, TAA compliant
- 3 years electronics, 3 years battery warranty (USA and Canada)

Specifications:

- Double-conversion online UPS with lead acid battery
- For indoor use in environmentally controlled areas or within environmental enclosures that maintain Operating Conditions
- Power Capacity: Specific to UPS
- Power Input:
 - Alternating current, 50/60 Hz autosensing
 - Voltage, 110-300 VAC depending on load level
- Power Output:
 - Voltage, supports 208/220/230/240 VAC (208/120 VAC or 240/120 VAC with optional transformer) selectable output Capacities derates to 90% at 208 Volt.
 - Frequency: 50/60 Hz ± 4 Hz
 - Waveform: THD (full load): < 4%
 - Overload capacity: 110% 10 min; 130% 1 min; >130% 1 sec
 - Efficiency: Up to 94% online mode or 99% ECO mode
- Battery:
 - VD5000B and VD6000B includes one VXBPB. VD10KB includes one VXBP9.
 - Order up to 2 additional similar battery packs for longer runtimes
 - Battery Chemistry: Sealed, maintenance-free lead acid
 - UPS Charger current: 1-4A
 - UPS Nominal/float voltage: 240/273 VDC
 - VXBPB, 2U external battery:
 - Dimensions: 3.5"H x 17.2"W x 27.4"D (89 mm x 437 mm x 696 mm)
 - Battery quantity and type: (20) 12V 5AH Lead Acid
 - VXBP9, 3U external battery:
 - Dimensions: 5.2"H x 17.2"W x 27.4"D (132 mm x 437 mm x 696 mm)
 - Battery quantity and type: (20) 12V 580W Lead Acid
- See battery runtime and order table
- Rack-Mount Spaces: 2U, includes mounting brackets
- Dimensions (HxWxD):
 - 3.5"H x 17.2"W x 23.6"D (89 mm x 437 mm x 600 mm)
- Weight: Specific to UPS
 - VD5000x: 33.1 lb (15.0 kg)
 - VD6000x: 33.1 lb (15.0 kg)
 - VD10KB: 39.7 lb (18.0 kg)
- Line cord: Hardwired (see ordering table)
- Receptacles: Hardwired or use Bypass Distribution Module (see ordering table)

Specifications (continued):

- Bypass Distribution Module
 - This UPS has terminal input and output
 - Add bypass distribution module to provide outlets and manual bypass between utility and UPS conditioned power
 - Note: When using a 6kVA unit with a L6-30P input connection, the unit will derate to 5kVA.
 - Model BDM2A (5, 6kVA):
 - Input connection: L6-30P with 6' (1.8 m) cord
 - Output connection: (2) L6-30R + (2) C19 with each breaker
 - Model BDM3A (5, 6 or 10kVA):
 - Input connection: Terminal blocks
 - Output connection: Terminal block + (2) L6-30R + (2) C19 with each breaker
 - Model BDM3B (5, 6 or 10kVA):
 - Input connection: Terminal blocks
 - Output connection: Terminal block + L6-30R with breaker
 - Model BDM3C (5, 6 or 10kVA):
 - Input Connection: Terminal blocks
 - Output connection: (2) L6-30R each with breaker

- Operating Conditions:
 - Temperature: 32-104°F (0-40°C)
 - Audible noise: Specific to UPS
 - 5000/6000VA: < 55 dBA
 - 10000VA: < 58 dBA
 - Elevation: 0-11,500' above sea level
- Approvals:
 - UL 1778, cUL, FCC, RoHS, CE, TAA compliant
- Warranty:
 - 3 years electronics, 3 years battery warranty (USA and Canada)
- Communications Interface:
 - RS-232 (2U only), USB, EPO, intelligent slot for optional card (Web/SNMP)
- Included in Box:
 - ViewPower software, user manual, horizontal brackets, and tower pedestals

Lead Acid Online UPS, 5000VA-10kVA:

UPS Rear View with Battery and Bypass Distribution Module attached:

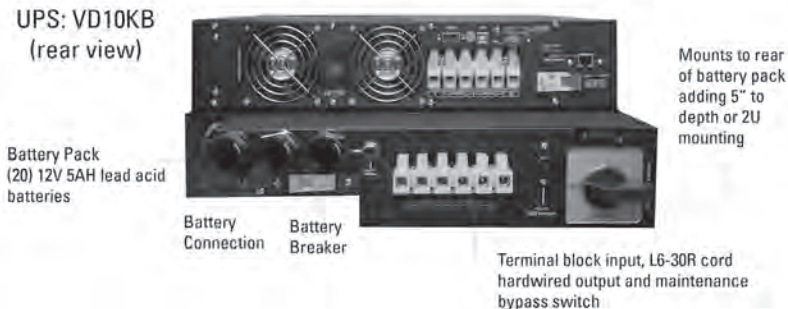

LEAD ACID ONLINE UPS, 5000VA-10KVA

Part Number	Capacity VA	Capacity W	Input Plug*	Output Receptacles	Runtime 100% Load	Runtime 50% Load	External Battery Option	Bypass Distribution Module Compatibility
200-240 Volt*								
VD5000B	5000	5000	Terminal Block	Terminal Block	7	21	VXBP8	BDM2A, BDM3A, BDM3B, BDM3C
VD65000B	6000	6000	Terminal Block	Terminal Block	5	15	VXBP8	BDM3A, BDM3B, BDM3C
VD10KB	10000	10000	Terminal Block	Terminal Block	2	7	VXBP9	BDM3A, BDM3B, BDM3C

Notes: Part numbers above include one Battery Pack. Order additional Extended battery packs and Maintenance Bypass module separately.

*Voltage input: 110-300 VAC (depending on load level)

*Voltage output: 208/220/230/240 selectable output. Capacity derates to 90% at 208 VAC output.

Battery Runtimes:

Battery Runtimes - Based on Load											
Battery P/N	Qty	1 kW	2 kW	3 kW	4 kW	5 kW	6 kW	7 kW	8 kW	9 kW	10 kW
VXBP8	1	53	27	15	11	7	5	4	4	3	2
	2	117	61	38	27	20	15	13	11	9	7
	3	171	100	62	43	33	27	22	18	15	13
VXBP9	1	92	46	29	20	15	12	10	8	7	6
	2	182	106	66	47	36	29	24	20	18	15
	3	287	151	107	76	58	47	39	33	29	25

Battery runtimes shown in minutes and will vary based on battery condition, age, cycles and ambient temperature. Maximum of three external battery packs per UPS.



Extended Runtime Battery Pack

Increase the on-battery runtime for UPS systems by adding additional external battery packs to the UPS. Each battery pack matches specific UPS models. Battery Packs use 2U of rack-mount space and should be placed adjacent to the supported UPS.

Rear Panel View

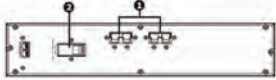

1. DC connector: connects to either UPS or 2nd battery box
2. DC breaker: Battery over-current protector breaker

Part Number	Description	Shipping Weight lb (kg)
VXBP1	Use with VL1500x/VL2000x UPS; 2U; 18.9"D (481 mm); Dims: 3.5"H x 17.2"W x 18.9"D (89 mm x 437 mm x 480 mm) Battery: (8) 12V 9AH / 48VDC, Black	74.6 (33.8)
VXBP2	Use with VL2000x/VL3000x UPS; 2U; 23.6"D (600 mm); Dims: 3.5"H x 17.2"W x 23.6"D (89 mm x 437 mm x 600 mm) Battery: (12) 12V 9AH / 72VDC, Black	104.4 (47.4)
VXBP3	Use with VL5000x UPS; 2U; 23.6"D (600 mm); Dims: 3.5"H x 17.2"W x 23.6"D (89 mm x 437 mm x 600 mm) Battery: (12) 12V 580W at 5 mi / 72VDC, Black	110.4 (50.1)
VXBP4	Use with VD1500x UPS; 2U; 18.9"D (481 mm); Dims: 3.5"H x 17.2"W x 18.9"D (89 mm x 437 mm x 480 mm) Battery: (6) 12V 9AH / 36VDC, Black	58.1 (25.2)
VXBP5	Use with VD1500x UPS; 2U; 23.6"D (600 mm); Dims: 3.5"H x 17.2"W x 23.6"D (89 mm x 437 mm x 600 mm) Battery: (12) 12V 9AH / 36VDC, Black	104.4 (50.1)
VXBP6	Use with VD2000x UPS; 2U; 18.9"D (481 mm); Dims: 3.5"H x 17.2"W x 18.9"D (89 mm x 437 mm x 480 mm) Battery: (8) 12V 9AH / 48VDC, Black	74.6 (33.8)
VXBP7	Use with VD3000x UPS; 2U; 23.6"D (600 mm); Dims: 3.5"H x 17.2"W x 23.6"D (89 mm x 437 mm x 600 mm) Battery: (12) 12V 9AH / 72VDC, Black	104.0 (47.4)
VXBP8	Use with VD5000x/VD6000x/VD10kx UPS; 2U; 27.4"D (696 mm); Dims: 3.5"H x 17.2"W x 27.4"D (89 mm x 437 mm x 696 mm) Battery: (20) 12V 5AH, Black	120.0 (54.4)
VXBP9	Use with VD5000x/VD6000x/VD10kx UPS; 3U; 27.4"D (696 mm); Dims: 5.2"H x 17.2"W x 27.4"D (132 mm x 437 mm x 696 mm) Battery: (20) 12V 580W, Black	160.0 (72.6)



SNMP1

Communications Card

Provide remote monitoring, management, and control of the UPS through a network connection from a web browser. Monitor input voltage, output voltage, frequency, temperature, load and capacity. View event, data and battery test logs. Supports RFC1628, SNMPv1/v2/v3 and PCC MIB. Support TCP/IP, IPv4, IPv6, HTTP, HTTPS, SSL, SSH, SMTP, SNMP, DHCP, Telnet, BOOTP, DNS, DDNS, PPPoE, and RADIUS protocols. Supports an optional external environmental sensor.



SNMP1EXT

Part Number	Description	Shipping Weight lb (kg)
SNMP1	Internal SNMP/WEB Card For VD/VL/LD UPS Models; 10/100 MB; Management and Shutdown of Remote Clients Via LAN; Black.	2 (0.9)
SNMP1EXT	Environmental Monitoring Sensor; Attaches to SNMP1 Card; Monitors Temperature, Humidity; Black	2 (0.9)



BDM1A



BDM1B



BDM1C



BDM1D



BDM2A



BDM3A

Maintenance Bypass Distribution Modules

Manually transfer critical load from UPS power to utility power to prevent power interruption when repairing or replacing the UPS. Provide surge protection on input power.

Part Number	Description	Shipping Weight lb (kg)
BDM1A	1U; Single-Phase; 120V; 15A; 12'L (3.6 m) Input Cord with 5-15P; 5-15R UPS Input; 5-15P UPS Output; (6) 5-15R Outlets Front + (4) 5-15R Outlets Rear; 1.75"H x 19"W x 3.5"D (45 mm x 489 mm x 89 mm); Black	5 (2.2)
BDM1B	1U; Single-Phase; 120V; 20A; 12'L (3.6 m) Input Cord with 5-20P; 5-20R UPS Input; 5-20P UPS Output; (6) 5-20R Outlets Front + (4) 5-20R Outlets Rear; 1.75"H x 19"W x 3.5"D (45 mm x 489 mm x 89 mm); Black	7 (3.1)
BDM1C	1U; Single-Phase; 200-240V; 16A; C20 Inlet; C19 UPS Input; C20 UPS Output; (2) C19 + (4) C13 Outlets Front + (4) C13 Outlets Rear; Includes (2) C20 to (C19) Cord Kits; 1.75"H x 19"W x 3.5"D (45 mm x 483 mm x 89 mm); Black	5 (2.2)
BDM1D	1U; Single-Phase; 120V; 30A; 6'L (1.8 m) Input Cord with L5-30P; L5-30R UPS Input; L5-30P UPS Output; (5) 5-20R Outlets Front + (5) 5-20R Outlets Rear; 1.75"H x 19"W x 3.5"D (45 mm x 483 mm x 89 mm); Black	5 (2.2)
BDM2A	For VD5000B/VD6000B UPS; L6-30P Input; (2) L6-30R + (2) C19 Outlets; 3.5"H x 14.6"W x 5"D (89 mm x 371 mm x 127 mm); Black	10 (4.5)
BDM3A	For VD5000B/VD6000B/VD10KB UPS; Terminal Block Input; Terminal Block + (2) L6-30R + (2) C19 Outlets; 3.5"H x 14.6"W x 5"D (89 mm x 371 mm x 127 mm); Black	10 (4.5)
BDM3B	For VD5000B/VD6000B/VD10KB UPS; Terminal Block Input; Terminal Block + (1) L6-30R + (2) C19 Outlets; 3.5"H x 14.6"W x 5"D (89 mm x 371 mm x 127 mm); Black	10 (4.5)
BDM3C	For VD5000B/VD6000B/VD10KB UPS; Terminal Block Input; (2) L6-30R Outlets; 3.5"H x 14.6"W x 5"D (89 mm x 371 mm x 127 mm); Black	11 (4.9)

Note: Mounts to rear of battery pack or in the rear of the rack. BDM1x models include surge protection. For 120 VAC BDM1A, BDM1B, and BDM1D models, maximum spike current is 6500A, energy dissipation is 114J, maximum clamping voltage is 330 VAC. For 200-240VAC BDM1C model, maximum spike current is 6500A, energy dissipation is 220J, maximum clamping voltage is 330 VAC. BDM2A and BDM3x models mount to the rear of the battery pack or in the rear of the rack.



XMERPDU1



XMERPDU2



XMERPDU3



XMERPDU4

Step Down Isolation Transformer Power Distribution Unit

Rack-mount transformer converts 240 VAC or 208 VAC input to 240 VAC, 208 VAC and 120 VAC output to power a mix of equipment.

Part Number	Description	Shipping Weight lb (kg)
XMERPDU1	1500W; 2U; Single-Phase; Black, 208V Input; 120V Output; IEC-C14 Inlet; (16) 5-15R Outlets; 3.5"H x 17.5"W x 15"D (89 mm x 445 mm x 381 mm)	48 (21.4)
XMERPDU2	4000W; 2U; Single-Phase; Black, 208V or 240V Input, 208/120V or 240/120V Output; 3'L (1.8 m) Input Cord with L6-30P; (1) L6-30R* and (12) 5-15-20R Outlets; Max. 120V Load is 4 kW; Rear Panel 208/240 Voltage Selection Switch; 3.5"H x 19"W x 18"D (89 mm x 483 mm x 458 mm)	150 (67.0)
XMERPDU3	6000W; 3U; Single-Phase; Black, 208V to 240/120V or 240V to 240/120V; Input Terminal Block; Output Terminal Block + (2) L14-30R and (8) 5-15/20R Outlets; 5.2"H x 17.3"W x 31.8"D (133 mm x 445 mm x 808 mm)	156 (69.3)
XMERPDU4	10kVA; 3U; Single-Phase; Black, 208V to 240/120V or 240V to 240/120V; Input Terminal Block; Output Terminal Block + (2) L14-30R and (8) 5-15/20R Outlets; 5.2"H; 17.3"W x 31.8"D (133 mm x 445 mm x 808 mm)	216 (96.4)

Note: L6-30R output voltage is passed through (not isolated) and the same as input.



UPSBRKT1



UPSRAILKIT4X



UPSHELFKIT2A



UPSRAILKIT2A

UPS Mounting Kits

Various mounting kit options for UPS, Extended Runtime Battery Packs and Isolation Transformer PDUs.

Part Number	Description	Shipping Weight lb (kg)
UPSRAILKIT4A	Four-Post Rail Kit for 800VA-3000VA UPS; Min Rail Depth 20" (508 mm); Max Rail Depth 32" (812 mm); Zinc	7 (3.1)
UPSRAILKIT4B	Four-Post Rail Kit for 5-10kVA UPS, Battery Packs and Transformer PDUs; Min Rail Depth 20" (508 mm); Max Rail Depth 32" (812 mm); Zinc	7 (3.1)
UPSRAILKIT2A	Two-Post Rail Kit for UPS; Rated For 125 lb (56 kg); 3"H x 4"W x 20"D (77 mm x 102 mm x 508 mm); Black	7 (3.1)
UPSHELFKIT2A	Two-Post Shelf for UPS; Rated For 150 lb (68 kg); 3.5"H x 21.5"W x 23.3"D (89 mm x 547 mm x 592 mm); Black	14 (6.3)
UPSBRKT1	Front Rack-mount Bracket for 800VA-3000VA UPS For Two-Post and Four-Post Racks, Black	2 (0.9)

Note: UPS and Battery Packs include Front Rack-mount Bracket (P/N UPSBRKT1).

Power Receptacles/Outlets

125V:

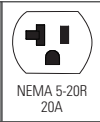
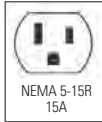

250V:

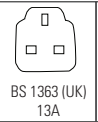

Power Plugs & Inlets:

100-250V Universal Inlet:

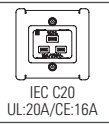
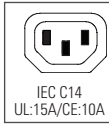

125V Single-Phase:

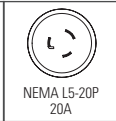
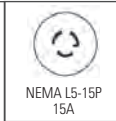
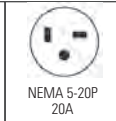
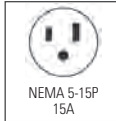

120/208V Single-Phase:

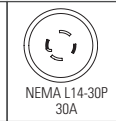
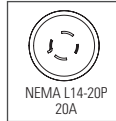

250V Single-Phase:

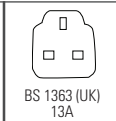
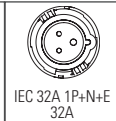
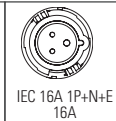
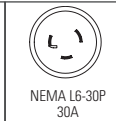
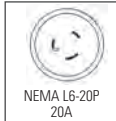

120/208V Three-Phase:

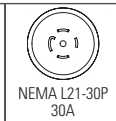
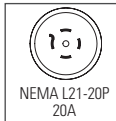

220-240V/380-415V Three-Phase:

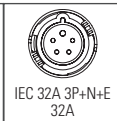
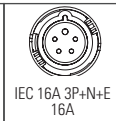
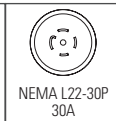
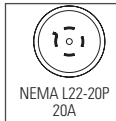

250V Three-Phase:

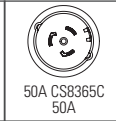
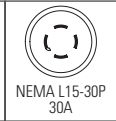
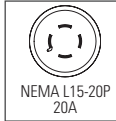

Extended Warranty

Chatsworth Products (CPI) Extended limited warranties on CPI-Branded Electronic hardware products are available for two additional years beyond the expiration of the Original Warranty Period (3 years). CPI's Extended Limited Warranty can be purchased concurrently with, or separately from, the initial purchase of the product until the expiration of the Original Warranty Period for that product.

UPS Models featuring Lithium-Ion batteries carry a standard 6-year warranty with no further warranty extensions. CPI-branded UPS models featuring Lead-Acid batteries carry a standard warranty of 3 years. Customers are invited to extend the standard 3-year warranty to 5 years by adding an additional 2 years of coverage. Extended warranty includes coverage of electronics and internal batteries on UPS's and advanced replacement with ground shipping both ways.

Contact CPI Customer Service, or visit chatsworth.com/warranty for more information.



Part Number	Description
L1-2YEXTWAR-ELECTRONICS-C	2-Year Warranty Extension for PDUs with MSRP up to \$1700
L2-2YEXTWAR-ELECTRONICS-C	2-Year Warranty Extension for PDUs with MSRP \$1701 - \$3400
L3-2YEXTWAR-ELECTRONICS-C	2-Year Warranty Extension for PDUs with MSRP > \$3400

Part Number	UPS Warranty
2YEXTWAR-UPSVL1	Five-Year Warranty: VL800x - VL1500x Single-Phase UPS
2YEXTWAR-UPSVL2	Five-Year Warranty: VL2000x - VL3000x Single-Phase UPS
2YEXTWAR-UPSVL3	Five-Year Warranty : VL5000x Single-Phase UPS
2YEXTWAR-BP1	Five-Year Warranty: VXBP1 or VXBP2 Extended Battery Pack
2YEXTWAR-UPSD1	Five-Year Warranty: VD1000x - VD1500x Single-Phase UPS
2YEXTWAR-UPSD2	Five-Year Warranty: VD2000x - VD3000x Single-Phase UPS
2YEXTWAR-BP2	Five-Year Warranty: VXBP4, VXBP5, VXBP6 or VXBP7 Extended Runtime Battery Pack
2YEXTWAR-UPSVD3	Five-Year Warranty: VD5000x/VD6000x/VD10Kx Single-Phase UPS
2YEXTWAR-BP3	Five-Year Warranty: VXBP8 or VXBP9 Extended Runtime Battery Pack

Start-Up Service

Onsite review of initial installation and system configuration of the UPS system. Scheduled visit during standard work week (5x8). Does not include physical installation or electrical connections. *Order one Start-Up Service per UPS

Part Number	Start-Up Service*
STARTUPUPSVD1	UPS Start-Up Service, 5x8, For First VD5000x, VD6000x or VD10Kx Single-Phase UPS
STARTUPUPSVD2	UPS Start-Up Service, 5x8, For Additional VD5000x, VD6000x or VD10Kx Single-Phase UPS, Performed Along With First Unit

Preventative Maintenance Service

Onsite preventative maintenance of UPS and batteries. Scheduled visit during standard work week (5x8). Does not include physical installation or electrical connections. ** Order one Preventative Maintenance Service per UPS. Covers one visit

Part Number	Preventive Maintenance Service**
PMUPSVD1	UPS Preventative Maintenance Service, One Visit For First VD5000x, VD6000x or VD10Kx Single-Phase UPS
PMUPSVD2	UPS Preventative Maintenance Service; One Visit For Additional VD5000x, VD6000x or VD10Kx Single-Phase UPS, Performed Along With First Unit

Onsite Service

Onsite UPS maintenance service coverage including start-up and corrective maintenance of electronics Scheduled visit during standard work week (5x8) Does not include physical installation or electrical connections. *** Additional plans available

Part Number	Onsite Service***
3YRONSITE-UPSVD1	UPS Onsite Services; Three Year 5x8 Service Plan for VD5000x, VD6000x, or VD10Kx Single-Phase UPS; Includes Onsite Start-up and Onsite Corrective Maintenance of Electronics.

SECTION 4

BONDING & GROUNDING

Busbars	4-3
Bonding Hardware	4-8
Bonding Accessories	4-14



*Learn about CPI's Standard Limited Warranty and Extended Limited Warranties.
See page vii for details.*

BONDING & GROUNDING

In response to the increase in newer, more sensitive, highly sophisticated electronic equipment, CPI offers a full line of UL® Listed Bonding & Grounding Products that are designed to provide protection and prevent transient voltages from damaging sensitive electronic equipment.

Where Can I Learn More?

To learn more about CPI's Bonding & Grounding Products, or to find additional part numbers not listed in this catalog, please visit our website, chatsworth.com

Related Tools:

Use these tools, under the Resources tab on chatsworth.com, to simplify your planning, selection, order and purchase of CPI Bonding & Grounding Products.

- BIM Drawings
- MasterFormat Specs
- Visio Shapes

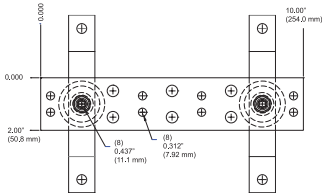

13622-010: (4) Lugs, 5/8" (15.88 mm) hole centers
(3) Lugs, 1" (25.4 mm) hole centers

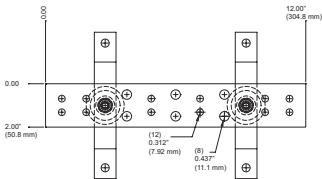

13622-012: (6) Lugs, 5/8" (15.88 mm) hole centers
(3) Lugs, 1" (25.4 mm) hole centers

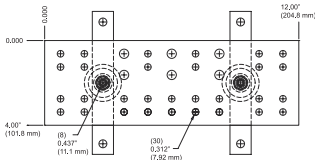

40153-012: (15) Lugs, 5/8" (15.88 mm) hole centers
(3) Lugs, 1" (25.4 mm) hole centers

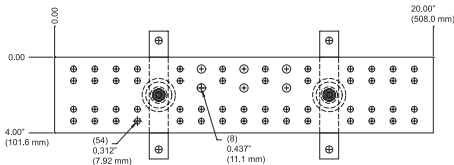

40153-020: (27) Lugs, 5/8" (15.88 mm) hole centers
(3) Lugs, 1" (25.4 mm) hole centers

BICSI & ANSI /TIA Bonding Busbars

The CPI 13622 series Secondary Bonding Busbar (SBB) provides a central bond attachment point for ICT systems located in the data room. The CPI 40153 series ICT Primary Bonding Busbar (PBB) provides a central bond attachment point for ICT bonding backbones, equipment and the building's ground electrode system. All CPI Bonding Busbars are UL Listed.

Hole patterns on Busbars accommodate two-hole lugs per the recommendation of ANSI/BICSI N3-20 and ANSI/TIA-607 standards. Insulators electrically isolate Busbars from the wall or other mounting surfaces, thereby controlling the current path.

- Mounting brackets are manufactured from high-quality 300 series stainless steel with 3/8" (9.53 mm) diameter mounting holes spaced 5.75" (146.1 mm) apart
- Busbars mount on the wall, floor or ceiling
- Ships preassembled
- Sold individually
- UL Listed, File E236184, Category KDER (US), KDER7 (Canada)
- Busbar assemblies with lug kits also available
- Other configurations available on request

Each Busbar consists of:

- (1) Busbar
- (2) insulators
- (2) stand-off brackets
- (4) stainless steel bolts with Torx T-45 head
- Order installation hardware separately

Part Number	Description	Busbar Size H x W x D in (mm)	Shipping Weight lb (kg)
13622-010	10 (250) SBB	2 x 10 x 1/4 (50 x 250 x 6.4)	3 (1.4)
13622-012	12 (300) SBB	2 x 12 x 1/4 (50 x 300 x 6.4)	4 (1.8)
40153-012	12 (300) PBB	4 x 12 x 1/4 (100 x 300 x 6.4)	7 (3.2)
40153-020	20 (510) PBB	4 x 20 x 1/4 (100 x 510 x 6.4)	8 (3.6)

Note: See details at left for lug sizes and quantities. Overall height with stand-off brackets is 6.63" (168 mm); overall depth is 3.13" (80 mm).

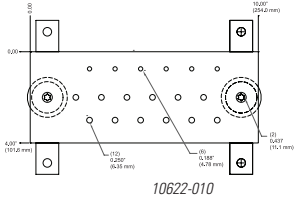

10622-010

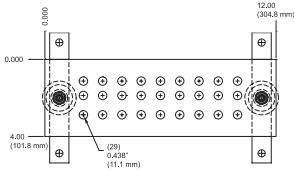

10622-012

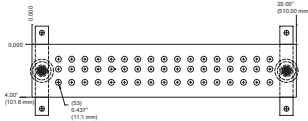

10622-020

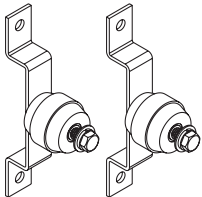

Sold in pairs

Standard Busbars

CPI Standard Busbars are insulated ground bus-mounting plates specifically designed for commercial applications. The hard-drawn electrolytic tough pitch 110 alloy solid copper ground bars are 1/4" (6.4 mm) thick and stand off 2.75" (69.9 mm) from the backboard or wall. The 10" (250 mm) Busbar accepts 1/4" single bolt lugs. The 12" and 20" (300 mm and 510 mm) Busbars provide connection for nine or 17 lugs respectively, accepting lugs with either 3/4", 1" or 1-3/4" (19.1 mm, 25 mm or 44.5 mm) center. Any lug with 3/8" bolts may be used.

- All Busbars ship individually and preassembled
- Other configurations available on request
- UL Listed, File E236184; Category KDER (US), KDER7 (Canada)

Each Busbar assembly consists of:

- (1) Busbar
- (2) insulators
- (2) stand-off brackets
- (4) stainless steel bolts with Torx T-45 head
- Order installation hardware separately

Part Number	Description	Busbar Size H x W x D in (mm)	Shipping Weight lb (kg)
10622-010	Busbar	4 x 10 x 1/4 (100 x 250 x 6.4)	4 (1.8)
10622-012	Busbar	4 x 12 x 1/4 (100 x 300 x 6.4)	5 (2.3)
10622-020	Busbar	4 x 20 x 1/4 (100 x 510 x 6.4)	8 (3.6)

Overall height with stand-off brackets is 6.63" (168 mm); overall depth is 3.13" (80 mm).

Busbar Insulator Assemblies

CPI also offers standalone Busbar Insulator Assemblies.

- Ships preassembled
- Replaces CPI P/N 13622-000

Pair of assemblies consists of:

- (2) stainless steel bolts, 3/8"W x 5/8"L
- (4) lock washers, 3/8"
- (4) flat washers, 3/8"
- (2) stainless steel bolts, 3/8"W x 3/4"L
- (2) insulators, 1-3/4"W x 1-7/8"D, 3/8" threaded insert
- (2) stainless steel wall brackets, 1"W (25 mm), 1" standoff
- Order installation hardware separately

Part Number	Description	Shipping Weight lb (kg)
10622-000	Busbar Insulator Assemblies, 1 Pair	2 (0.9)

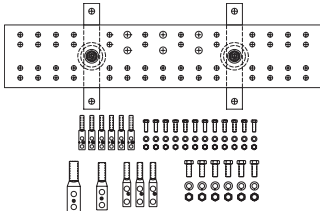

Busbar Assemblies With Lug Kits

Busbar Assemblies with Lug Kits contain the CPI 13622 series Telecommunications Secondary Bonding (SBB) or the CPI 40153 series Primary Bonding Busbar (PBB), along with required stainless steel hardware to fasten the two-hole bonding lugs to the Busbar.

- #6 lugs are 2-hole lugs with 1/4" hardware
- #2, 2/0 and 4/0 lugs are 2-hole lugs with 3/8" hardware
- Order installation hardware separately
- UL Listed, File E236184, Category KDER (US), KDER7 (Canada) - Grounding and Bonding Equipment

40158-020 Shown

Part Number	Description	Busbar Size H x W x D in (mm)	#2 Lug	#6 Lug	2/0 Lug	4/0 Lug	Shipping Weight lb (kg)
40156-012	SBB Pattern	2 x 12 x 1/4 (50 x 300 x 6.4)	3 each	6 each	1 each	0 each	5 (2.3)
40158-020	PBB Pattern	4 x 20 x 1/4 (100 x 510 x 6.4)	3 each	6 each	1 each	1 each	11 (5.0)
40158-012	PBB Pattern	4 x 12 x 1/4 (100 x 300 x 6.4)	3 each	6 each	1 each	1 each	8 (3.6)

Overall height with stand-off brackets is 6.63" (168 mm); overall depth is 3.13" (80 mm).

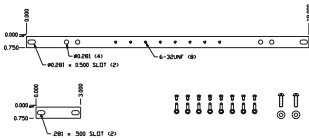

19" rack width Busbar shown

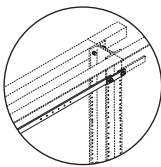

Shown mounted to rack

Horizontal Rack Bonding Busbar

Horizontal Rack Bonding Busbar (RBB) for consolidating equipment bonding conductors. Constructed of 3/16"-thick x 3/4"H (4.763 mm x 19.1 mm) hard-drawn electrolytic tough pitch 110 alloy copper bar with eight #6-32 tapped lug mounting holes on 1" (25.4 mm) centers and two pairs of 5/16" (7.938 mm) diameter holes spaced 3/4" (19.1 mm) apart for attaching equipment bonding conductors.

- Other configurations available on request
- UL Listed, File E236184, Category KDER (US), KDER7 (Canada) - Grounding and Bonding Equipment

Part number consists of Busbar and a hardware kit that includes:

- (1) splice plate bar, 3"L (80 mm)
- (2) #12-24 copper machine screws
- (2) #12 copper flat washers
- (8) #6-32 copper machine screws
- (8) #6 ring terminals
- Order installation hardware separately

Part Number	Description	Rack Width (in)	Shipping Weight lb (kg)
10610-019	Horizontal Rack Bonding Busbar	19	2 (0.9)
10610-023	Horizontal Rack Bonding Busbar	23	3 (1.4)
10610-035	Horizontal Rack Bonding Busbar	35	4 (1.8)

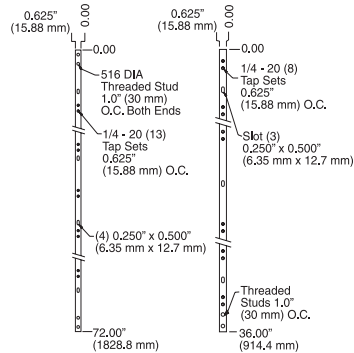

Vertical Rack Bonding Busbar

Vertical Rack Bonding Busbar (RBB) for consolidating equipment bonding connections. Constructed of 5/8" H x 1/4" W (15.88 mm x 6.4 mm) hard-drawn electrolytic tough pitch 110 alloy copper bar with pairs of #1/4-20 tapped mounting holes on 5/8" (15.88 mm) centers. The 36" L (910 mm) bar has one set of #5/16 self-clinching studs on 1" (25.4 mm) centers at one end for attachment of a bonding conductor. The 72" L (1830 mm) bar has two sets of #5/16 self-clinching studs on 1" (25.4 mm) centers at both ends for attachment of a bonding conductor.

- Each package contains one Vertical Rack Busbar
- Vertical Rack Busbars with insulators and lug kits are also available
- Other configurations are available on request
- UL Listed, File E236184, Category KDER (US), KDER7 (Canada) - Grounding and Bonding Equipment

Part Number	Description W x D x L in (mm)	Number of Lugs	Shipping Weight lb (kg)
40160-036	5/8 x 1/4 x 36 (15.88 x 6.4 x 910)	8	4 (1.8)
40160-072	5/8 x 1/4 x 72 (15.88 x 6.4 x 1830)	13	5 (2.3)

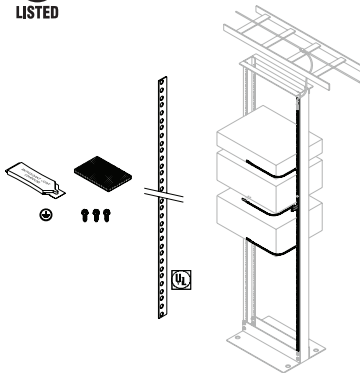

Vertical Rack Bonding Busbar Kit

The Rack Bonding Busbar (RBB) Kit includes a thin strip of tinned copper that attaches to the rack's equipment mounting rail to provide direct bonding contact for rack-mount equipment or a convenient bonding strip. Sized to fit a 7" (2.1 m) high rack with an EIA-310 Universal hole pattern and 45U, the busbar is punched with a series of holes that align with each mounting hole on the rack. When equipment is mounted to the rack, the rack-mount brackets touch the busbar. Alternately, the Equipment Bonding Jumper Kit can be used to connect equipment to the busbar.

- Each kit includes one ground bar, three #12-24 zinc-plated thread forming hex washer head installation screws, an abrasive pad, joint compound and a ground label
- The ground bar is .05" (1.3 mm) thick tinned copper strip, 78.65" H x .68" W (1997 mm x 17 mm) and is punched with holes that match the EIA-310 Universal Hole Pattern
- UL Listed Ground Bar, File E236184, Category KDER (US), KDER7 (Canada) - Bonding and Grounding Equipment

Part Number	Description	Shipping Weight lb (kg)
40172-001	Vertical Rack Bonding Busbar Kit, For 45U, 7" (2.1 m) Racks	2 (0.9)

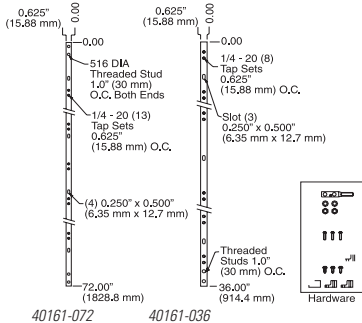

Vertical Rack Bonding Busbar Kits

Vertical Rack Bonding Busbar (RBB) Kits isolate the Busbar from the rack to help control current paths from passing through one piece of equipment to another.

- Other configurations are available on request
- UL Listed, File E236184, Category KDER (US), KDER7 (Canada) - Bonding and Grounding Equipment
- The 36"L (910 mm) bar has one set of #5/16 self-clinching studs on 1" (25.4 mm) centers at one end for attachment of a equipment bonding conductor. The 72"L (1830 mm) bar has two sets of #5/16 self-clinching studs on 1" (25.4 mm) centers at both ends for attachment of a equipment bonding conductor.

Kit consists of:

- (1) Vertical Rack Bonding Busbar
- (1) #2 AWG two-hole ground compression lug with 3/8" (9.53 mm) holes on 1" (25.4 mm) centers
- (3) white Delrin® insulator blocks
- (3) self-tapping screws
- (3) #12-24 mounting screws
- (2) stainless steel lock washers, 5/16"
- (2) nuts

Part Number	Description W x D x L in (mm)	Number of Lugs	Shipping Weight lb (kg)
40161-036	5/8 x 1/4 x 36 (15.88 x 6.4 x 910)	6 (2.7)	4 (1.8)
40161-072	5/8 x 1/4 x 72 (15.88 x 6.4 x 1830)	7 (3.2)	5 (2.3)

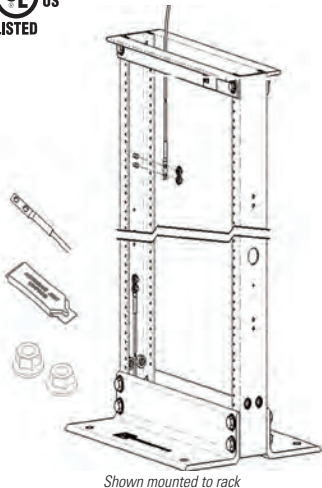

Rack Bonding Jumper Kit

Rack Bonding Jumper Kits serve as a rack bonding conductor for CPI's Universal and Standard Racks. CPI's Universal Racks include a location for attaching the Rack Bonding Jumper Kit inside the rack's vertical equipment mounting channel. Order additional hardware as required to secure the other end of the jumper to the telecommunications equipment bonding conductor or directly to a telecommunications bonding busbar.

Kit consists of:

- 9'L (2.7 m) #6 AWG stranded copper conductor insulated green with a horizontal yellow stripe attached to a two-hole compression lug with 1/4" (6.35 mm) bolt holes spaced on 5/8" (15.88 mm) centers
- 1/4-20 zinc plated serrated flange hex nuts
- 0.5 oz (14 g) packet of aluminum antioxidant joint compound
- Constructed of UL Listed components, File E236184, Category KDER (US), KDER7 (Canada) - Bonding and Grounding Equipment
- Available individually or in packages of 10

Part Number	Description	Number of Lugs	Shipping Weight lb (kg)
40159-008	Rack Bonding Jumper Kit, 1 Each	2 (0.9)	4 (1.8)
40159-018	Rack Bonding Jumper Kit, Pack of 10	12 (5.4)	5 (2.3)

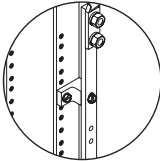

Shown mounted
between rack and
Busbar

Rack Busbar Insulator Block

Rack Busbar Insulator Blocks provide rigid support to physically separate Rack Busbars from all sources of electrical energy. Its offset design securely attaches the Busbar using a #12 self-tapping screw, while allowing unobstructed access to rack-mounted equipment. The Insulator Block has a #12 clearance hole for mounting to the rack.

- Made of durable, nonconductive white Delrin®
- Block measures 3/4" H x 1 1/16" W x 1-1/4" L (19.1 mm x 17.463 mm x 31.8 mm)

Part Number	Description	Shipping Weight lb (kg)
40157-001	Insulator Block, Each	1 (0.5)
40157-050	Insulator Block, Box of 50	2 (0.9)

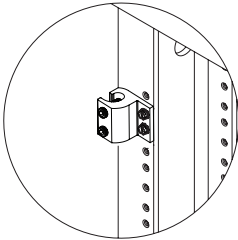

Two Mounting Hole Ground Terminal Block

CPI's Two Mounting Hole Ground Terminal Block provides a convenient way to attach ground wires to racks or cabinets and meets BICSI and ANSI/EIA/TIA two-hole mounting recommendations. Constructed of extruded, highstrength aluminum and accepts conductors ranging from #14 AWG through 2/0. Includes two #3/8-24 x 7/8" L stainless steel hex head set screws.

Part Number	Description	Wire Size	Shipping Weight lb (kg)
40167-001	Two-Hole Block, Each	#14-2/0	1 (0.5)
40167-010	Two-Hole Block, Pack of 10	#14-2/0	10 (5.4)

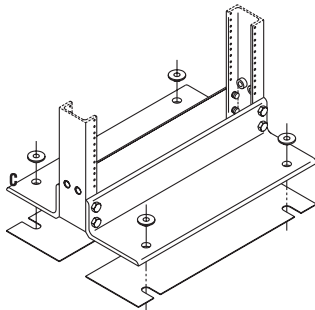

Rack Base Insulator Kit

Rack Base Insulator Kits electrically isolate the racks from the floor for an effective Bonding and Grounding system. Made of .060" (1.52 mm) thick phenolic insulating material and accepts up to 1/2" diameter screws. Used on concrete floors, not needed for access floor applications.

Kit consists of:

- (2) isolation plates; (4) isolation grommets

Part Number	Description	Shipping Weight lb (kg)
10605-019	Insulator Kit, 19" Rack	3 (1.4)
10605-023	Insulator Kit, 23" Rack	3 (1.4)

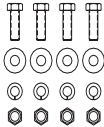
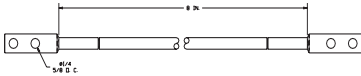

Shown mounted across runway splice point

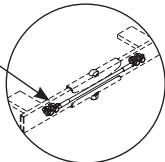

Cable Runway Bonding Strap Kit

Cable Runway Bonding Strap Kits provide a bonding pathway between cable runway lengths when fastened together across splices. Installation requires drilling 5/16" holes. Bonding Straps consist of an 8" (200 mm) #6 AWG green insulated stranded copper conductor with a helical yellow stripe attached at both ends to two-hole compression lugs with 1/4" bolt holes spaced on 5/8" (15.88 mm) centers.

- Overall length of 11" (280 mm)
- Available individually or in packages of 25
- Constructed of UL Listed components, File E515394, Category KDER (US), KDER7 (Canada) - Bonding and Grounding Equipment
- Other configurations available on request

Kit consists of:

- (4) stainless steel cap screws, #1/4-20 x 3/4" L
- (4) flat washers, 1/4"
- (4) lock washers, 1/4"
- (4) nuts, 1/4"

Part Number	Description	Shipping Weight lb (kg)
40164-001	#6 AWG Bonding Strap, Each	1 (0.5)
40164-025	#6 AWG Bonding Straps, Pack of 25	12 (5.0)

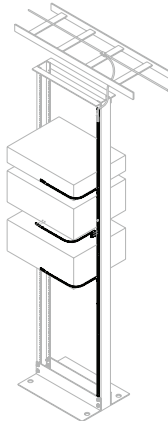
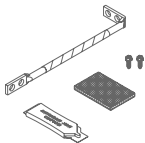

Equipment Bonding Jumper Kit

Use the Equipment Bonding Jumper Kit with the Vertical Rack Busbar Kit to bond rack-mount equipment. The Equipment Bonding Jumper Kit includes a 24" (710 mm) insulated green/yellow helical stripe #6 AWG bonding conductor with a Slotted Compression Lug on one end and a 90° Slotted Compression Lug on the other end. The 90° Slotted Lug attaches to the busbar, allowing easy alignment with equipment. The Slotted Compression Lug attaches to equipment. The kit includes an abrasive pad, antioxidant joint compound and two installation screws to prepare and secure the jumper to the busbar or ground bar. The installer must provide installation hardware for the lug that attaches to equipment.

- Each kit includes (1) 24" (710 mm) insulated bonding jumper with attached lugs, (2) plated installation screws, an abrasive pad and joint compound
- The lugs are made from electroplated tinned copper and have (2) mounting holes spaced .5" to .625" apart that accept 1/4" screws
- UL Listed Components, File E236184, Category KDER (US), KDER7 (Canada) - Bonding and Grounding Equipment

Part Number	Description	Shipping Weight lb (kg)
40159-010	Equipment Bonding Jumper Kit	2 (0.9)



Ground Wire

- Ground Wire is a #6 AWG, 133-strand, green insulated MTW conductor with a yellow helical stripe
- Sold in a 100' (30 m) length on a spool

Part Number	Description	Shipping Weight lb (kg)
40159-001	Ground Wire, #6 AWG, 100 (30) Spool	14 (6.4)



Shown mounted on rack

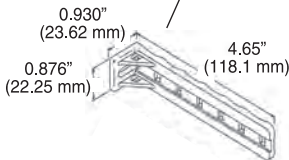
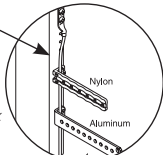

Bonding Jumper

Bonding Jumpers provide common bonding from equipment rack or cabinet to the Telecommunications Equipment Bonding Conductor. Can be used with CPI "L" Brackets (P/N 10001-001 or 10559-500) to attach cable run vertically along equipment rack or cabinet. Bonding jumpers are constructed of a 9'L (2.7 m) #6 AWG stranded copper conductor insulated green with a horizontal yellow stripe attached to a compression lug with two 1/4" bolt holes spaced on 5/8" centers.

- Available individually or in packages of 10
- Constructed of UL Listed components, File E236184, Category KDER (US), KDER7 (Canada) - Bonding and Grounding Equipment
- Other configurations available on request

Part Number	Description	Shipping Weight lb (kg)
40159-009	9 (2.7) Green Jumper, Each	2 (0.9)
40159-019	9 (2.7) Green Jumper, Pack of 10	20 (9.1)

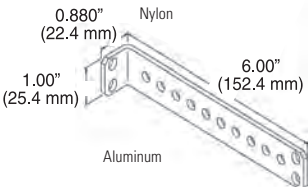

Stand-Off Tie-Down "L" Brackets

These "L" brackets mount to the back of the rack channel to provide a convenient tie-down point for bonding and grounding cable runs. Available in nonconductive nylon or high-strength aluminum construction. Either end of the aluminum bracket can be attached to the rack or cabinet face, allowing cable run in several different ways.

Part Number	Description	Shipping Weight lb (kg)
10001-001	1 x 5 (30 x 130) White Nylon, Each	1 (0.5)
10001-050	1 x 5 (30 x 130) White Nylon, Pack of 50	3 (1.4)
10559-X00	1 x 6 (30 x 150) Aluminum, Each	1 (0.5)
10559-X50	1 x 6 (30 x 150) Aluminum, Pack of 50	3 (1.4)

X=Color, 1=Gray, 2=Computer Beige, 5=Clear, 7=Black, E=Glacier White.

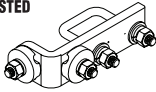

Cross Connector

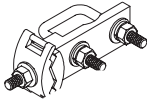
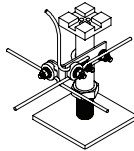

Straight Connector

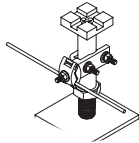

Pedestal Clamp with Bonding Connector

Support bonding conductors from round or square raised floor pedestals using the Pedestal Clamp with Bonding Connector. The connector provides a bonding connection for the pedestal and supports up to four conductors from the pedestal. Use to create a signal reference grid under the raised access floor using #6 AWG or 2/0 bare round conductor.

- Use Cross Connectors to create signal reference grid intersections; support up to (4) conductors, 2 per side, size #6 AWG or 2/0
- Use Straight Connectors to support the signal reference grid in-between intersections; support 1 or 2 conductors on one side of the pedestal only, size #6 AWG or 2/0
- Manufactured from electroplated copper or bronze (P/N 40169-003) with stainless steel installation hardware
- PNs 40169-001 and 40169-002 are UL Listed, File E236184, Category KDER (US), KDER7 (Canada) - Bonding and Grounding Equipment

Part Number	Description	Pedestal Style, Diameter in (mm)	Number and Size of Connectors	Shipping Weight lb (kg)
40169-001	Pedestal Clamp, Cross Connector	Square, 1-1/8 (28) OD	(2) #6 AWG per side	2 (0.9)
40169-002	Pedestal Clamp, Cross Connector	Round, 1-1/8 (28) to 1-3/4 (44) OD	(1) #6 AWG and (1) 2/0 per side	2 (0.9)
40169-003	Pedestal Clamp, Straight Connector	Square or Round, 1-1/8 (28) OD	(2) #6 AWG or (2) 2/0 one side only	2 (0.9)

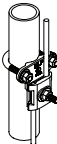
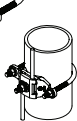
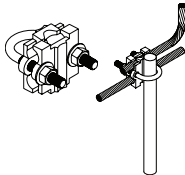

Note: P/N 40170-001 supports parallel attachment of only one conductor or perpendicular attachment of two conductors. All other clamps support parallel or perpendicular attachment of two conductors. Conductors must be the same size.

Pipe Clamp with Bonding Connector

Support bonding conductors from metal pipes of various sizes with the Pipe Clamp. The connector provides a bonding connection for the pipe and supports up to two conductors parallel or perpendicular to the pipe. Select the Pipe Clamp with Bonding Connector to match the size of the pipe.

- UL Listed, File E236184, Category KDER (US), KDER7 (Canada) - Grounding and Bonding Equipment
- Supports 1 or 2 conductors; conductors must be the same size
- Use with conductors ranging in size from #6 up to 250 MCM
- Attach conductors parallel or perpendicular to the pipe
- Manufactured from electroplated tinned bronze with stainless steel hardware

Part Number	Pipe Size / Diameter Ranges	Nominal Size / Outside Diameter	Shipping Weight lb (kg)
40170-001	5-.75 (10-19)	.375-1 (9.5-30)	2 (0.9)
40170-002	1-1.25 (30-31.8)	.75-1.7 (19-43)	2 (0.9)
40170-003	1.5-2 (38-50)	1-2.4 (30-61)	2 (0.9)
40170-004	2.5-3 (64-80)	2.25-3.5 (58-89)	2 (0.9)
40170-005	3.5-4 (89-100)	3.2-4.5 (81-114)	2 (0.9)
40170-006	5-6 (130-150)	5.63-6.63 (143-169)	2 (0.9)

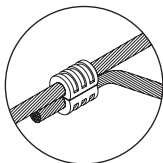
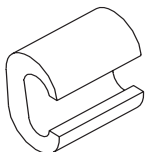

Shown connecting two copper conductors

C-Type Compression Taps

C-Type Compression Taps connect two copper conductors with the use of a hydraulic crimping tool.

- Available individually or in bulk packages
- Other sizes available on request
- UL Listed

Part Number	Tap Description	Run Description	Quantity	Shipping Weight lb (kg)
40163-004	#2 Stranded #2 Solid	#2 Stranded #2 Solid	1	1 (0.5)
40163-054	#2 Stranded #2 Solid	#2 Stranded #2 Solid	50	4 (1.8)
40163-003	#2 Stranded #2 Solid	#4 Stranded #8 Solid	1	1 (0.5)
40163-053	#2 Stranded #2 Solid	#4 Stranded #8 Solid	50	6 (2.7)
40163-002	#4 Stranded #4 Solid	#4 Stranded #6 Solid	1	1 (0.5)
40163-052	#4 Stranded #4 Solid	#4 Stranded #6 Solid	50	3 (1.4)
40163-001	#4 Stranded #6 Solid	#6 Stranded #6 Solid	1	1 (0.5)
40163-051	#4 Stranded #6 Solid	#6 Stranded #6 Solid	50	3 (1.4)
40163-005	2/0 Stranded 1/0 Solid	#2 Stranded #8 Solid	1	1 (0.5)
40163-055	2/0 Stranded 1/0 Solid	#2 Stranded #8 Solid	10	1 (0.5)
40163-007	2/0 Stranded 1/0 Solid	2/0 Stranded 1/0 Solid	1	1 (0.5)
40163-057	2/0 Stranded 1/0 Solid	2/0 Stranded 1/0 Solid	10	1 (0.5)
40163-006	4/0 Stranded 3/0 Solid	#2 Stranded #6 Solid	1	1 (0.5)
40163-056	4/0 Stranded 3/0 Solid	#2 Stranded #6 Solid	10	1 (0.5)
40163-008	4/0 Stranded 3/0 Solid	2/0 Stranded 1/0 Solid	1	1 (0.5)
40163-058	4/0 Stranded 3/0 Solid	2/0 Stranded 1/0 Solid	10	2 (0.9)
40163-009	4/0 Stranded 3/0 Solid	4/0 Stranded 3/0 Solid	1	1 (0.5)
40163-059	4/0 Stranded 3/0 Solid	4/0 Stranded 3/0 Solid	10	2 (0.9)



Compression Tool

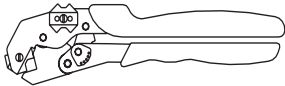

Crimp Tool

Mechanical Compression Tools

Mechanical Compression Tools are used to attach compression lugs and butt splices (not recommended for use with C-Tap connections). The tools feature long steel handles with comfortable rubber grips. The Dieless Compression Tool works with either copper or aluminum conductors. The Crimp Tool comes complete with dies and features extra-long handles for two-handed crimping.

Part Number	Description	Size	Unit	Shipping Weight lb (kg)
40165-001	Compression Tool, Dieless	Copper #8-250 MCS Aluminum #8-4/0	24 (610)	5 (2.3)
40165-002	Crimp Tool	#8-1/0	10.5 (267)	3 (1.4)



Compression Lugs

Connect copper or tinned copper conductors to Busbars, racks, cabinets or Cable Runway. Manufactured from electroplated tinned copper conductors

- Available individually or in bulk quantities in 3 styles; Two-Hole, Slotted and 90° Slotted

Part Number	Description	Cable Size	Hole Spacing in (mm)	Hole Size in (mm)	Color Code	Quantity	Shipping Weight lb (kg)
40162-901	Two-Hole Lug	#6	.625 (15.9)	.250 (6.4)	Blue	1	1 (0.5)
40162-951	Two-Hole Lug	#6	.625 (15.9)	.250 (6.4)	Blue	50	2 (0.9)
40162-902	Two-Hole Lug	#6	.750 (19.1)	.375 (9.5)	Blue	1	1 (0.5)
40162-952	Two-Hole Lug	#6	.750 (19.1)	.375 (9.5)	Blue	50	2 (0.9)
40162-903	Two-Hole Lug	#6	1.00 (25.4)	.375 (9.5)	Blue	1	1 (0.5)
40162-953	Two-Hole Lug	#6	1.00 (25.4)	.375 (9.5)	Blue	50	2 (0.9)
40162-904	Two-Hole Lug	#2	.625 (15.9)	.250 (6.4)	Brown	1	1 (0.5)
40162-954	Two-Hole Lug	#2	.625 (15.9)	.250 (6.4)	Brown	25	2 (0.9)
40162-905	Two-Hole Lug	#2	.750 (19.1)	.375 (9.5)	Brown	1	1 (0.5)
40162-955	Two-Hole Lug	#2	.750 (19.1)	.375 (9.5)	Brown	25	2 (0.9)
40162-907	Two-Hole Lug	#2	1.00 (25.4)	.375 (9.5)	Brown	1	1 (0.5)
40162-957	Two-Hole Lug	#2	1.00 (25.4)	.375 (9.5)	Brown	25	2 (0.9)
40162-909	Two-Hole Lug	2/0	1.00 (25.4)	.375 (9.5)	Black	1	1 (0.5)
40162-959	Two-Hole Lug	2/0	1.00 (25.4)	.375 (9.5)	Black	10	2 (0.9)
40162-910	Two-Hole Lug	2/0	1.75 (44.5)	.500 (12.7)	Black	1	2 (0.9)
40162-960	Two-Hole Lug	2/0	1.75 (44.5)	.500 (12.7)	Black	10	2 (0.9)
40162-911	Two-Hole Lug	4/0	1.00 (25.4)	.375 (9.5)	Purple	1	1 (0.5)
40162-961	Two-Hole Lug	4/0	1.00 (25.4)	.375 (9.5)	Purple	10	2 (0.9)
40162-912	Two-Hole Lug	4/0	1.75 (44.5)	.500 (12.7)	Purple	1	1 (0.5)
40162-962	Two-Hole Lug	4/0	1.75 (44.5)	.500 (12.7)	Purple	10	3 (1.4)
40162-913	Slotted Lug	#6	.500 (12.7)/.625 (15.9)	.250 (6.4)	Blue	1	1 (0.5)
40162-963	Slotted Lug	#6	.500 (12.7)/.625 (15.9)	.250 (6.4)	Blue	25	2 (0.9)
40162-914	90° Slotted Lug	#6	.500 (12.7)/.625 (15.9)	.250 (6.4)	Blue	1	1 (0.5)
40162-964	90° Slotted Lug	#6	.500 (12.7)/.625 (15.9)	.250 (6.4)	Blue	25	2 (0.9)

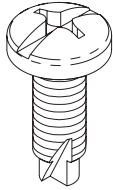

Clean-Thread Screws

The #12-24 Combination Pan Head, Pilot Point Mounting Screws attach equipment to racks and cabinets. A cutting notch in the thread removes paint in threaded holes to improve metal-to-metal contact. The pilot point reduces cross-threading. The combination head can be used with #3 Phillips and slotted screwdrivers.

- Zinc finish
- Available in packages of 50 and 1,000

Part Number	Description	Unit	Shipping Weight lb (kg)
40605-001	#12-24 Screws	50	1 (0.5)
40605-004	#12-24 Screws	1,000	9 (4.1)
40605-005	#12-24 (Black) Screws	50	1 (0.5)
40605-006	#12-24 (Black) Screws	1,000	9 (4.1)

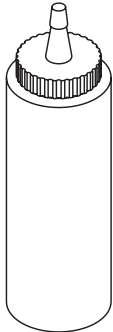

8 oz (230 g)

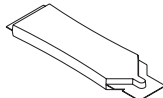

.5 oz (14 g)

Aluminum-To-Aluminum Or Aluminum-To-Copper Antioxidant Joint Compound

Recommended for all aluminum-to-aluminum and aluminum-to-copper connectors, bare conductors, busbars, insulated conductors and conduit threads.

- Zinc finish
- Available in packages of 50 and 1,000

Part Number	Description	Size	Unit	Shipping Weight lb (kg)
40166-101	Antioxidant, Gray	.5 (14)	1	1 (0.5)
40166-801	Antioxidant, Gray	8 (230)	1	1 (0.5)
40166-150	Antioxidant, Gray	.5 (14)	50	2 (0.9)
40166-812	Antioxidant, Gray	8 (230)	12	6 (2.7)

- Oxide inhibiting joint compound is used to improve the electrical conductivity and enhance the integrity of any grounding or bonding connection
- Good for all voltages
- Assures a high-connectivity joint by sealing out air and moisture to prevent corrosion and reformation of oxide film
- Also used as an anti-seizing thread lubricant and ensures continuity of ground on aluminum conduit threads
- Bulk packaging quantities available

Copper-To-Copper Joint Compound

Recommended for all copper-to-copper connections, copper threads and all mechanical/pressure type bonding and grounding connections.

Part Number	Description	Size	Unit	Shipping Weight lb (kg)
40168-101	Antioxidant, Copper	.5 oz	1	1 (0.5)
40168-801	Antioxidant, Copper	8 oz	1	1 (0.5)
40168-150	Antioxidant, Copper	.5 oz	50	2 (0.9)
40168-812	Antioxidant, Copper	8 oz	12	6 (2.7)

SECTION 5

CABLE PATHWAY

Universal Cable Runway	5-3
Adjustable Cable Runway	5-4
Runway Junction Products	5-11
Runway Mounting Products	5-15
Runway Accessories	5-27



*Learn about CPI's Standard Limited Warranty and Extended Limited Warranties.
See page vii for details.*

CABLE PATHWAY

Support backbone and horizontal cables between the point of entry and exit into the telecommunications or equipment rooms and cross-connects on racks or cabinets with CPI Cable Pathway Products. A wide selection of supports, splices and accessories are available.

Where Can I Learn More?

To learn more about CPI's Cable Pathway Products, or to find additional part numbers not listed in this catalog, please visit our website, chatsworth.com

Related Tools:

Use these tools, under the Resources tab on chatsworth.com, to simplify your planning, selection, order and purchase of order and purchase of CPI Cable Pathway Products.

- Visio Shapes
- CAD Blocks
- BIM Drawings
- Cable Fill
- MasterFormat Specs

Featured Product:

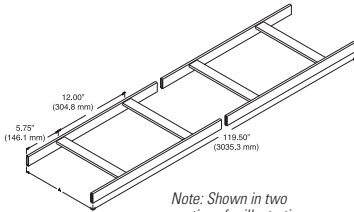
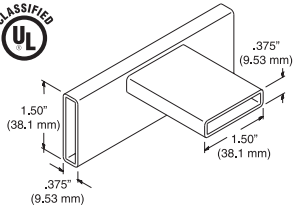

Note: Shown in two sections for illustrative purposes, actual product is one piece.

Universal Cable Runway

Designed for value-conscious customers, the Universal Cable Runway offers the industry-standard features you have come to expect. With the runway supported every 5' (1.5 m), maximum load with minimal deflection is 132 lb/ft (196 kg).

- Made of 3/8" x 1-1/2" x .065" (9.53 mm x 38 mm x 1.65 mm) wall rectangular steel tubing, Cross members welded at 12" (300 mm) intervals
- Standard length is 9'-11 1/2"/119.5" (3035 mm)
- UL Classified for suitability as an equipment bonding conductor only (must remove paint or use ground straps)
- Installation Best Practices includes Runway Elevation Kit

Part Number	Description Width (Dim. A) in (mm)	Shipping Weight lb (kg)
10250-X04	4 (100)	18 (8.2)
10250-X06	6 (150)	19 (8.6)
10250-X09	9 (230)	20 (9.1)
10250-X12	12 (300)	25 (11.3)
10250-X15	15 (380)	27 (12.2)
10250-X18	18 (460)	29 (13.2)
10250-X24	24 (610)	32 (14.5)
10250-X31	30 (760)	35 (15.7)
10250-X37	36 (910)	38 (17.2)

X=finish; 1=Gray, 7=Black, E=Glacier White.

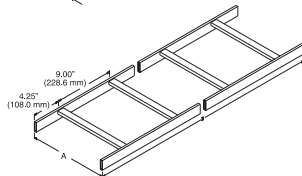
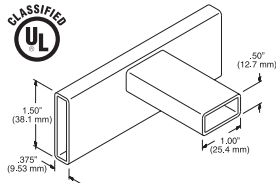

Note: Shown in two sections for illustrative purposes, actual product is one piece.

UL Classified Cable Runway

Similar in construction to our TELCO-Style Cable Runway (11252 series). The side stringers are 1 1/2" x 3/8" x .065" (38.1 mm x 9.53 mm x 1.65 mm), and the cross members are 1/2" x 1" x .065" (12.7 mm x 30 mm x 1.65 mm), welded at 9" (230 mm) intervals.

- Available in Gold chem finish or Black chem over zinc plating
- UL Classified for suitability (as an equipment grounding conductor only)
- The overall length is 9' 8-1/2"/116.5" (2959 mm) to comply with TELCO-Style standards
- Individually boxed to prevent scratching and damage
- Installation Best Practices include Runway Elevation Kit

Part Number	Width (Dim. A) in (mm)	Length (Dim. B) in (mm)	Shipping Weight lb (kg)
11275-X06	6 (150)	9' 8-1/2 (2959)	19 (8.6)
11275-X09	9 (230)	9' 8-1/2 (2959)	20 (9.1)
11275-X12	12 (300)	9' 8-1/2 (2959)	22 (10.0)
11275-X15	15 (380)	9' 8-1/2 (2959)	26 (11.8)
11275-X18	18 (460)	9' 8-1/2 (2959)	28 (12.7)
11275-X20	20 (510)	9' 8-1/2 (2959)	29 (13.2)
11275-X24	24 (610)	9' 8-1/2 (2959)	31 (14.1)

X=color over zinc: 0=Gold Chem, 7=Black



Adjustable Runway Cross Members



Highly Adaptable with Tool-less Cable Management Accessories

Adjustable Cable Runway

Designed to provide a flexible point-to-point solution anywhere cables enter or exit the cable pathway. The Adjustable Cable Runway features unique, movable Cross Members, which allow components and accessories to be installed at various points along the runway—a feature that simplifies the alignment of cabling above racks, cabinets and cable managers. The Adjustable Cable Runway is cross-compatible with CPI's Universal (10250), TELCO (11252) and UL Classified (11275) runway, making it an excellent solution for any challenging cabling environment.

Features:

- Features movable Cross Members for ultimate cable pathway customization
- Supports cable and fiber from floors, ceilings, walls and the tops of cabinets and racks
- Simplifies moves, adds and changes
- Supports tool-less accessories for quick and easy deployment
- Complements other CPI Runway Systems
- Adapts to any data center or computer room
- Ships assembled or unassembled
- Bonded construction

Specifications:

- Includes roll-formed Stringers with bolted aluminum Cross Members
- 132 lb/ft (196 kg/m) when the runway is supported every 5' (1.5 m)
- For indoor use only, in environmentally controlled areas
- Stringers: 119.5" (3085 mm) high-strength, low-alloy steel with 1: (25 mm) repeating-hole pattern and rounded corners
- Cross Members: 0.80" x 1.5" (20.3 mm x 38 mm) extruded aluminum, T-shaped Cross Members
- Thread-forming screws cut through paint to form electrical bond between Stringers and Cross Members
- Use with CPI Bonding and Grounding products for ANSI/TIA-942-A-B compliance
- Includes: (2) Stringers; (10) Cross Members (20) M8 x 20, TapTite Thread-forming Hexalobular (T40) Screws
- UL Classified for suitability as an equipment bonding conductor only (must remove paint or use ground straps)

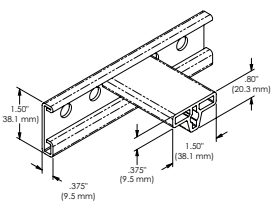

Part Number	Adjustable Cable Runway 1.5" H x 119.5" L (38 mm x 3035 mm) Assembled, Width - in(mm)	Shipping Weight lb (kg)
14300-X04	4 (102)	17 (8)
14300-X06	6 (152)	18 (8)
14300-X09	9 (229)	19 (8)
14300-X12	12 (305)	20 (9)
14300-X15	15 (381)	21 (10)
14300-X18	18 (457)	22 (10)
14300-X24	24 (610)	25 (11)
14300-X30	30 (762)	27 (12)
14300-X36	36 (914)	30 (13)

Notes: X= color: 1=Gray, 7=Black, E=Glacier White



Adjustable Cable Runway Bonding Strap

The Adjustable Cable Runway Bonding Strap provides a bonding pathway between runway lengths. It consists of an 8" L (200 mm) #6 AWG stranded insulated copper conductor and are attached to a two-hole compression lug with 5/16" bolt holes at both ends. Bolt holes are spaced on 1" (25 mm) centers to match hole-to-hole spacing on the Adjustable Cable Stringers.

- Overall length 10.8" (273 mm)
- UL Listed Components
- Hardware includes: (4) Stainless steel cap screws, #5/16-18 x 7/8" L; (4) Flat washers, 5/16", (4) Lock washers, 5/16" and (4) Nuts, 5/16"

Part Number	Description	Shipping Weight lb (kg)
14307-001	Bonding Strap Kit, 10.8" L (273 mm), Each	1 (0.5)
14307-025	Bonding Strap Kit, 10.8" L (273 mm), Pack of 25	25 (11.4)

Note: Hole-to-hole spacing aligns with prepunched holes on Adjustable Cable Runway Stringers without drilling. Also compatible with all CPI Runway systems.

PATENTED



Pathway Dividers feature Click Secure Technology

Tool-less Pathway Dividers

The patented Tool-less Pathway Dividers divide cable runway into multiple pathways to organize cables by media type or destination—a solution that enables technicians to better manage moves, adds and changes. Hinged design opens up to wrap around cross members and features CPI's Click Secure Technology.

- Compatible with all styles of CPI Runway
- Manufactured from polycarbonate/acrylonitrile butadiene styrene (PC/ABS) material
- UL 94-V0 flammability rating for optimum impact and heat resistance

Part Number	Description	Shipping Weight lb (kg)
14308-001	6" H (152), Pack of 10, Black	2 (1.0)
14308-002	6" H (152), Pack of 100, Black	15 (7.0)

PATENTED



Tool-less Cross Member Radius Drop

The Tool-less Cross Member Radius Drop is designed for compatibility with 1.5" x 3/8" (38 mm x 9.53 mm) Stringers and installs without the need for tools, mounting directly to the sides of the runway.

- May be positioned over or between the Runway Cross Members
- Use hook-and-loop, along with the tie-down slots to fully deploy the cable support solutions
- Provides 3" (76.2 mm) bend radii; Includes 1.4"H (36 mm), 1" (25 mm) diameter ABS cable spools to separate and guide cables
- Compatible with all styles of CPI Runway
- Manufactured from steel; spools are plastic
- For appropriate fit, match Cross Member Radius Drop width to runway width

Part Number	Description	Shipping Weight lb (kg)
14304-X04	4"W (102), Each, 2 Spools	2 (1.0)
14304-X06	6"W (152), Each, 2 Spools	2 (1.0)
14304-X09	9"W (229), Each, 2 Spools	2 (1.0)
14304-X12	12"W (305), Each, 3 Spools	3 (1.5)
14304-X15	15"W (381), Each, 3 Spools	3 (1.5)
14304-X18	18"W (457), Each, 3 Spools	4 (2.0)
14304-X24	24"W (610), Each, 3 Spools	6 (3.0)
14304-X30	30"W (762), Each, 3 Spools	7 (3.0)
14304-X36	36"W (914), Each, 5 Spools	7 (3.0)

Notes: X=color: 1=Gray, 7=Black, E=Glacier White

PATENTED

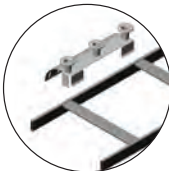

Tool-less Stringer Radius Drop

The Tool-less Stringer Radius Drop features simple, tool-less installation.

- Use hook-and-loop, along with the tie-down slots to fully deploy the cable support solutions.
- Provides 3" (76.2 mm) bend radii
- Supplied with 1.4"H (36 mm), 1" (25 mm) diameter, cable spools to separate and guide cables
- Unique design slips over the Runway Stringers and clamps in position; fits Runway Stringers that are 1-1/2"H x 3/8"W (38 mm x 9.53 mm)
- Compatible with all CPI Runway systems

Part Number	Description	Shipping Weight lb (kg)
14305-X00	Large, 10.5 (268), Each, 3 Spools	3 (1.0)
14305-X01	Small, 5.5 (140), Each, 2 Spools	2 (1.0)

Notes: X=color: 1=Gray, 7=Black, E=Glacier White

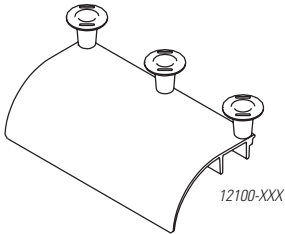

12100-XXX

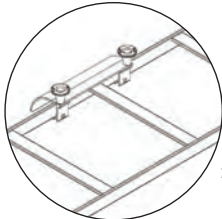

12101-XXX

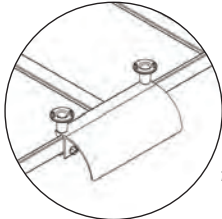

12101-XXX

Cable Runway Radius Drop

Mounts to the side stringer or cross member of CPI Cable Runway to help maintain proper Category 5e/6/Ba or fiber bend radii.

- Cross Member Radius Drop (P/N 12100-XXX) fits 6", 9", 12" and 18"W (150 mm, 230 mm, 300 mm and 460 mm) cross member tubing on CPI Universal Runway (Series 10250)
- Stringer Radius Drop (P/N 12101-XXX) attaches to the side or straddles the rungs of the runway cross member
- Provides 3" (80 mm) bend radius
- Products 5"W (130 mm), 12100-X06, 12101-X03, drop into CPI's 6"W (150 mm) vertical cabling sections
- Supplied with 1-1/2" (38.1 mm) cable spools (P/N 15003-001) to separate and guide cables
- Sold individually

Part Number	Cable Runway Width - in (mm)	Product Width in (mm)	Cable Spools
Runway Radius Drop, Cross Member			
12100-X06	6 (150)	5 (130)	2 each
12100-X09	9 (230)	8 (200)	2 each
12100-X12	12 (300)	11 (280)	3 each
12100-X18	18 (460)	17 (430)	3 each

Part Number		Runway Application	Product Width in (mm)	Cable Spools
Attaches to Side	Attaches to Side or Ring			
Runway Radius Drop, Stringer, Adjustable				
12101-X01	12101-X11	Universal	10.3 (260)	2 each
12101-X02	12101-X12	Telco	7.8 (197)	2 each
12101-X03	12101-X13	Misc.	5 (130)	3 each

X=color: 1=Gray, 7=Black, E=Glacier White.

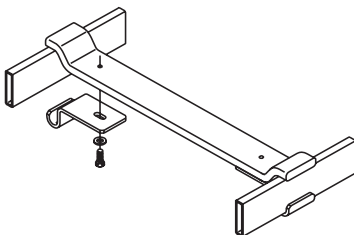

Cable Runway Movable Cross Member

Permits the dropping of cables at any point between cross members of 9", 12" or 18"W (230 mm, 300 mm or 460 mm) Cable Runways. Combine with the recommended Cable Runway Radius Drop.

- Fits on standard Cable Runway only — 1-1/2" x 3/8" stringer (38.1 mm x 9.53 mm)
- Can be used as an attachment point for the Cable Runway Radius Drops listed below
- Easy installation using provided hardware

Part Number	Cable Runway in (mm)	Use with Radius Drop
12115-X09	9 (230)	12100-X06
12115-X12	12 (300)	12100-X09
12115-X18	18 (460)	12100-X12

X=color: 1=Gray, 7=Black, E=Glacier White.

PATENTED



Pathway Dividers feature Click Secure Technology

Tool-less Pathway Dividers

The patented Tool-less Pathway Dividers divide cable runway into multiple pathways to organize cables by media type or destination—a solution that enables technicians to better manage moves, adds and changes. Hinged design opens up to wrap around cross members and features CPI's Click Secure Technology.

- Compatible with all styles of CPI Runway
- Manufactured from polycarbonate/acrylonitrile butadiene styrene (PC/ABS) material
- UL 94-V0 flammability rating for optimum impact and heat resistance
- Sold in packs of 10 and 100; Finish: Black

Part Number	Description	Shipping Weight lb (kg)
14308-001	6"H (152), Pack of 10, Black	2 (1.0)
14308-002	6"H (152), Pack of 100, Black	15 (7.0)



Cable Runway Dividers

Divide Cable Runway into multiple cable pathways in order to organize cables according to media type or destination. By organizing horizontal cables by destination according to route or zone, technicians can better manage cables when additional cables are added, or when the cable path through the building changes due to building renovations.

- Cable spools separate cables into individual pathways for better organization of cables
- Spools have a smooth surface to protect cable jackets from damage during installation or maintenance
- Easy installation with included hardware
- Universal/Trough Style Dividers fit 3/8"H x 1-1/2"W (9.53 mm x 38.1 mm) cross members on CPI Universal or Trough Cable Runway
- TELCO/UL Classified Style Dividers fit 1/2"H x 1"W (13 mm x 30 mm) cross members on CPI TELCO or UL Classified Cable Runway

Part Number	Description	Shipping Weight lb (kg)
Universal or Trough Style Dividers		
13392-X11	Divider, Package of 5	1 (0.5)
13392-X12	Divider, Package of 25	3 (1.4)
TELCO or UL Classified Style Dividers		
13392-X21	Divider, Package of 5	1 (0.5)
13392-X22	Divider, Package of 25	3 (1.4)

X=finish; 7=Black, E=Glacier White. Cable spool is black.

PatchRack For CPI Cable Runway

The PatchRack is a miniature two-post rack that can be attached to CPI Cable Runway to save rack-mount space by placing patch panels or interconnect equipment above the rack or cabinet. Use PatchRack to create a zone network in the data center.

Two versions are available; Racks P/N 13395 attach to the Cable Runway side stringer with a 7" D (180 mm) standoff bracket, and Racks P/N 13394 attach to a cross member underneath the Cable Runway. The position of the rack can be adjusted front-to-back or side-to-side. Racks P/N 13395 can also attach perpendicular to Cable Runway that is 12"W (300 mm) or less. Use the Cross Member Hardware Kit P/N 13399-702 for perpendicular mounting of all racks on any width of Cable Runway.

- Attaches to all CPI Cable Runway but optimized for 1-1/2"H x 3/8"W (38.1 mm x 9.53 mm) side stringers or cross members to Universal Cable Runway
- Supports 19"W rack-mount equipment; supports up to 60 lb (27.2 kg)
- Side Stringers (P/N 13395) are compatible with all styles of CPI Runway; Cross Members (P/N 13394) are not compatible with Adjustable Cable Runway



Part Number	Description	Shipping Weight lb (kg)
13395-X04	With Side Stringer Brackets, 4U	5 (2.3)
13395-X08	With Side Stringer Brackets, 8U	7 (3.2)
13394-X04	With Cross Member Brackets, 4U*	4 (1.8)
13394-X08	With Cross Member Brackets, 8U*	6 (2.7)

X=color: 1=Gray, 5=Clear, 7=Black, E=Glacier White. Gray and Black kits include black colored hardware. Does not include Side Stringer Brackets. *Attaches to Cross Member in parallel orientation only.

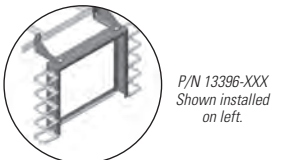
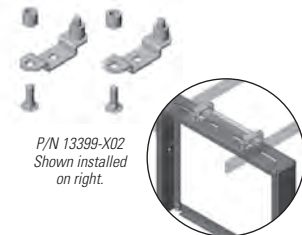

Accessories For PatchRack

Use Cross Member Hardware Kit for perpendicular mounting on all widths of Cable Runway. The D-Ring Kit provides cable management.

- Not compatible with Adjustable Cable Runway

Part Number	Description	Shipping Weight lb (kg)
13399-702	Cross Member Hardware Kit, Black	1 (0.5)
13396-704	D-Rings for 4U Rack, 6 Rings, Black	2 (0.9)
13396-708	D-Rings for 8U Rack, 10 Rings, Black	2 (0.9)

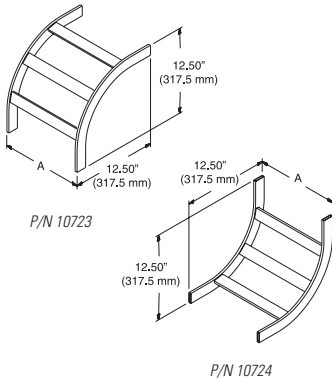

Cable Runway Radius Bend

Creates a gradual bend for cascading cable runs.

- Made of lightweight 1-1/2" x 3/8" (38.1 mm x 9.53 mm) tubular steel
- Three cross members welded at approximately 23° increments
- Outside/Inside is determined by welding cross members closer to cable side

Part Number 90° Outside Bend	Part Number 90° Inside Bend	Width (Dim. A) in (mm)
10723-X06	10724-X06	6 (150)
10723-X09	10724-X09	9 (230)
10723-X10	10724-X10	10 (250)
10723-X12	10724-X12	12 (300)
10723-X15	10724-X15	15 (380)
10723-X18	10724-X18	18 (460)
10723-X20	10724-X20	20 (510)
10723-X24	10724-X24	24 (610)
10723-X31	10724-X31	30 (760)
10723-X37	10724-X37	36 (910)

X=Color, 0=Gold, 1=Gray, 7=Black, E=Glacier White. Only gold radius bends are UL Classified.

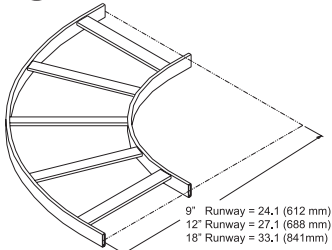

Cable Runway E-Bend

Creates a 90° gradual sweep in horizontal plane for Cable Runway runs. Designed for cabling in conformance with minimum bend radii requirements (typically 4 times the cable diameter). Made of lightweight 1-1/2" x 3/8" (38.1 mm x 9.53 mm) tubular steel to fit standard Cable Runway. Cross members welded at approximately 23° increments.

- Conforms to cable bend radii requirements
- Easy installation using CPI Butt-Splices (P/N 11301-001, not included)

Part Number	Cable Runway Width in (mm)	Width (Dim. B) in (mm)
10822-X06	6 (150)	21.1 (536)
10822-X09	9 (230)	24.1 (612)
10822-X10	10 (250)	25.1 (638)
10822-X12	12 (300)	27.1 (688)
10822-X15	15 (380)	30.1 (765)
10822-X18	18 (460)	33.1 (841)
10822-X20	20 (510)	35.1 (892)
10822-X24	24 (610)	39.1 (993)
10822-X31	30 (760)	45.1 (1146)
10822-X37	36 (910)	51.1 (1298)

X=Color, 0=Gold, 1=Gray, 7=Black, E=Glacier White. Only gold E-Bends are UL Classified.

All part numbers listed on this page are compatible with all styles of CPI Runway.

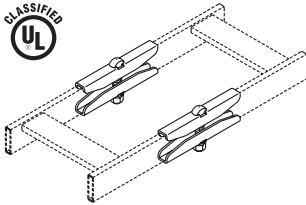

Butt-Splice Kit

Connect two sections of runway end-to-end. Fits both solid and tubular steel 1-1/2" x 3/8" and 2" x 3/8" (38.1 mm x 9.53 mm and 50.8 mm x 9.53 mm).

• Part numbers are compatible with Adjustable Cable Runway except P/N 11301-X02

Kit includes:

- (4) splice plates; (2) 3/8-16 trimmed head bolts; (2) 3/8-16 hex nuts; (2) 3/8" split lock washers

Part Number	Description in (mm)	Shipping Weight lb (kg)
11301-X01*	Butt-Splice Kit, 1-1/2 x 3/8 (38 x 9.53) Stringer	1 (0.5)
11301-X02*	Butt-Splice Kit, 2 (50.8) Stringer	1 (0.5)
16301-X01*	UL Classified Butt-Splice Kit	1 (0.5)

*X=color over zinc: 0=Gold, 7=Black. Gold kits include gold colored hardware. Black kits include black colored hardware.

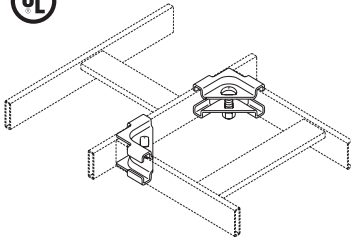

Junction-Splice Kit

Used to create a 90° junction splice with all types of 1-1/2" x 3/8" or 2" x 3/8" (38.1 mm x 9.53 mm and 50.8 mm x 9.53 mm) Cable Runway.

• Part numbers are compatible with Adjustable Cable Runway except P/N 11302-X02

Kit includes:

- (4) corner clamp plates; (2) 3/8-16 x 1 3/8" trimmed head bolts; (2) 3/8-16 hex nuts; (2) 3/8 split lock washers

Part Number	Description in (mm)	Shipping Weight lb (kg)
11302-X01	Junction-Splice Kit 1-1/2 x 3/8 (38mm x 9.53) Stringer	1 (0.5)
11302-X02	Junction-Splice Kit 2 x 3/8 (50.8 x 9.53) Stringer	1 (0.5)
16302-X01	UL Classified Junction Kit	1 (0.5)

X=color over zinc: 0=Gold, 7=Black

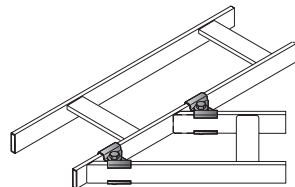

Adjustable Junction-Splice Kit

Adjusts to form any junction angle for cabling that requires a large radius bend or to route around existing plumbing, electrical, etc.

• Compatible with Adjustable Cable Runway Kit includes:

- (4) adjustable corner plates; (2) 3/8-16 x 2" hex cap screws; (2) 3/8-16 hex nuts; (2) 3/8 lock washers

Note: Requires one kit to attach one end of cable runway.

Part Number	Description	Shipping Weight lb (kg)
10616-X01	Adjustable Junction Splice Kit	2 (0.9)

X=color over zinc: 0=Gold, 7=Black

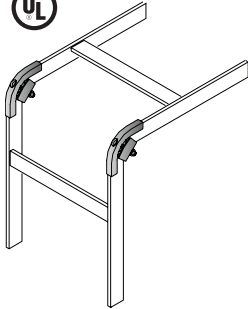

90° Runway-Splice Kit

Designed to butt-splice 1-1/2" (38.1 mm) Cable Runway at a 90° angle.

- Compatible with Adjustable Cable Runway Kit includes:
- (2) 90° outside clamps; (2) Inside edge clamps; (2) 3/8-16 trimmed round head, square neck bolts; (2) 3/8-16 hex nuts and lock washers

Part Number	Description in (mm)	Shipping Weight lb (kg)
11314-X01	90° Runway-Splice Kit, 1-1/2 x 3/8 (38.1 x 9.53) stringer	1 (0.5)
16314-X01	UL Classified 90° Runway-Splice Kit	1 (0.5)

X=color over zinc: 0=Gold, 7=Black

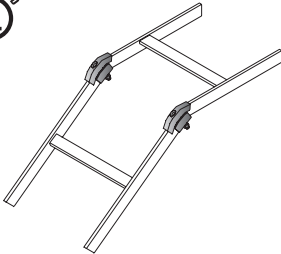

45° Runway-Splice Kit

Butt-splices Cable Runway at a 45° angle.

- Compatible with Adjustable Cable Runway

Kit includes:

- (2) 45° outside clamps; (2) Inside edge clamps; (2) 3/8-16 trimmed round head, square neck bolts; (2) 3/8-16 hex nuts and lock washers

Part Number	Description in (mm)	Shipping Weight lb (kg)
11313-X01	45° Runway-Splice Kit, 1-1/2 x 3/8 (38.1 x 9.53) stringer	1 (0.5)
16313-X01	UL Classified 45° Runway-Splice Ki	1 (0.5)

X=color over zinc: 0=Gold, 7=Black

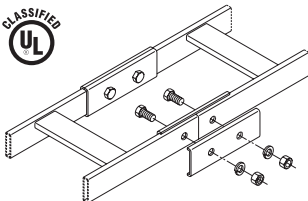

Heavy-Duty Butt-Splice Kit

For butting two lengths of Runway together. Cable Runway drilling is required.

- Bolt through Butt-Splice Kit for earthquake areas
- Not compatible with Adjustable Cable Runway

Kit includes:

- (4) splice plates for 1-1/2" stringers; (4) 3/8-16 x 1-1/4" hex cap screws; (4) 3/8-16 hex nuts; (4) 3/8" split lock washers

Part Number	Description	Shipping Weight lb (kg)
11299-X01*	Heavy-Duty Butt-Splice Kit	2 (0.9)
16299-X01*	UL Classified Heavy-Duty Butt-Splice Kit	2 (0.9)

*X=color over zinc: 0=Gold, 7=Black. Gold kits include gold colored hardware. Black kits include black colored hardware.

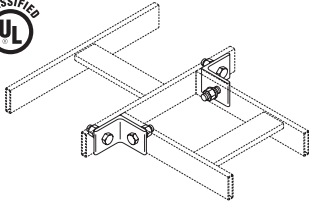

Heavy-Duty Junction-Splice Kit

Bolt-through Junction-Splice Kit for vertical runs or to meet seismic requirements. Cable Runway drilling is required.

- Material is 2" x 2" x 3/16" (50 mm x 50 mm x 4.763 mm) steel angle
- Not compatible with Adjustable Cable Runway

Kit includes:

- (2) splice angles; (4) 3/8-16 x 1-1/4" hex cap screws; (4) 3/8-16 hex nuts; (4) 3/8 split lock washers

Part Number	Description	Shipping Weight lb (kg)
11298-X01*	Heavy-Duty Junction Splice	3 (1.4)
16298-X01*	UL Classified Junction Kit	3 (1.4)

*X=color over zinc: 0=Gold, 7=Black. Gold kits include gold colored hardware. Black kits include black colored hardware.

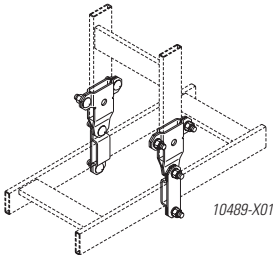
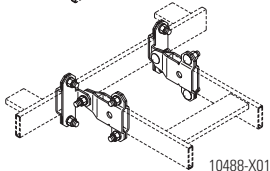
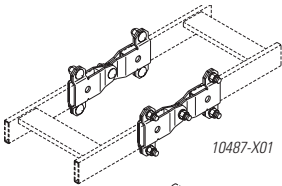

Swivel Splice Kits

Splices cable runway vertically, horizontally or perpendicularly. Flexible swivel design adjusts to any angle, not limited to 45° or 90°. Material is steel. Hardware and instructions are included.

- Compatible with Adjustable Cable Runway

Butt Swivel (10487) Kit includes:

- (8) bracket end; (8) 5/16-18 x 3/4" round head square, neck bolts; (2) 5/16-18 x 1" round head square, neck bolts; (10) 5/16-18 hex nuts, split lock washers

Junction Swivel (10488) Kit includes:

- (4) bracket end; (2) bracket supports and plate clamps; (2) 5/16-18 x 1" round head square, neck bolts; (8) 5/16-18 x 3/4" round head square, neck bolts; (10) 5/16-18 hex nuts, split lock washers

Vertical Swivel (10489) Kit includes:

- (4) bracket end; (2) bracket clamps and plate clamps; (2) 5/16-18 x 1" round head, square neck bolts; (6) 5/16-18 x 3/4" round head, square neck bolts; (8) 5/16-18 hex nuts, split lock washers

Part Number	Description	Shipping Weight lb (kg)
10487-X01	Butt-Swivel Splice Kit	1 (0.5)
10488-X01	Junction Swivel Splice Kit	1 (0.5)
10489-X01	Vertical Swivel Splice Kit	1 (0.5)
16487-X01	UL Classified Butt Swivel Splice Kit	1 (0.5)
16488-X01	UL Classified Junction Swivel Splice Kit	1 (0.5)
16489-X01	UL Classified Vertical Swivel Splice Kit	1 (0.5)

X=color over zinc: 0=Gold, 7=Black

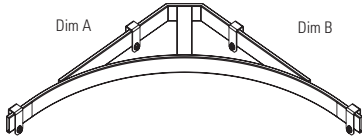

Dimension	15" W (380 mm) in (mm)	24" W (610 mm) in (mm)
A	15.48 (393.2)	24.13 (612.9)
B	15.48 (393.2)	24.13 (612.9)

Cable Runway Corner Bracket

Creates a radius for L, T or X-shaped intersections of Cable Runway formed when two or more pieces of Cable Runway are connected together with the Junction-Splice Kit (P/N 11302 or 16302) or Heavy-Duty Junction-Splice Kit (P/N 11298 or 16298).

- Single-piece welded assembly fabricated from 3/8" x 1-1/2" x .065" (9.53 mm x 38.1 mm x 1.65 mm) wall rectangular steel tubing
- Easy installation; brackets/hardware included
- Compatible with Adjustable Cable Runway

Part Number 15" W (380 mm)	Part Number 24" W (610 mm)	Description
11959-X15	11959-X24	Corner Bracket

X=Color over zinc: 0=Gold, 1=Gray, 7=Black, E=Glacier White.

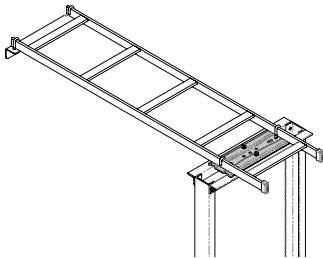

Rack Not Included

Cable Runway Wall To Rack Kit

The CPI Cable Runway Wall To Rack Kit is a one part number solution to the problem of providing support for cable between the rack and the wall. Kit includes:

- (1) 4' 6" L/54" (1370 mm) Universal Cable Runway; (1) Wall angle support bracket; (1) Rack to runway mounting plate; (1) Pair of end caps; (6) J-bolts

Note: The kit is available with runway that is 6", 9" or 12" W (150 mm, 230 mm or 300 mm). Rack is not included.

Part Number	Description	Shipping Weight lb (kg)
Standard/Universal Racks with 3"D (80 mm) Mounting Channels Width - in (mm)		
11911-X06	6 (150) Cable Runway Wall to Rack Kit	24 (10.9)
11911-X09	9 (230) Cable Runway Wall to Rack Kit	28 (12.7)
11911-X12	12 (300) Cable Runway Wall to Rack Kit	32 (14.5)
Standard Rack with 6"D (150 mm) Mounting Channels Width - in (mm)		
31473-X06	6 (150) Cable Runway Wall to Rack Kit	17 (7.7)
31473-X09	9 (230) Cable Runway Wall to Rack Kit	19 (8.6)
31473-X12	12 (300) Cable Runway Wall to Rack Kit	24 (10.9)

X=Color: 1=Gray, 7=Black, E=Glacier White. Gold and Glacier White kits have gold colored hardware. Gray and Black kits have black colored hardware.

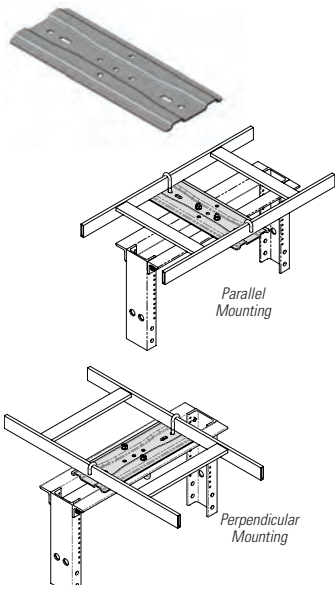

3" (80 mm) Channel Rack-To-Runway Mounting Plate

Secures Cable Runway to the top of Standard and Universal Racks. Mounts either parallel or perpendicular to the rack. For proper attachment of 6" W (150 mm) Cable Runway, specify a rack with top bars instead of top angles.

- Installation Best Practices include Runway Elevation Kit (P/N 10506-XXX)

P/N 10595-XXX consists of:

- (1) mounting plate; (4) 5/16-18 x 2 1/4" J-bolts ; (4) 5/16-18 hex nuts; (4) 5/16 split lock washers

P/N 12408-X24 consists of:

- (1) mounting plate; (2) 5/16-18 x 3 1/4" J-bolts; (2) 5/16-18 x 2 1/4" J-bolts; (4) 5/16-18 hex nuts; (4) 5/16 split lock washers

Part Number	Runway Width in (mm)	Plate Material	Shipping Weight lb (kg)
10595-X04	4 (100)	Steel	4 (1.8)
10595-X08	5 to 8 (130 to 200)	Steel	5 (2.3)
10595-X12	9 to 12 (230 to 300)	Steel	5 (2.3)
10595-X18	15 to 18 (380 to 460)	Steel	7 (3.2)
12408-X24	20 to 24 (510 to 610)	Aluminum	4 (1.8)

*X=*color (10595): 0=Gold, 1=Gray, 7=Black, E=Glacier White. *X=*color (10408): 1=Gray, 5=Clear, 7=Black, E=Glacier White. Gold and Glacier White kits have gold colored hardware. Gray and Black kits have black colored hardware.

3" (80 mm) Channel Rack-To-Runway Mounting Plate With Bracket

Secures Runway to the top of Universal Rack without intruding into mounting space. The combination of the plate and hat-shaped bracket form a clamp around the rack's top angles or top bars. Mounts parallel or perpendicular to the rack. For proper attachment of 6" runway, use top bars (13045 Series) rather than top angles. Installation Best Practices include Runway Elevation Kit (P/N 10506)

Kit includes:

- (1) mounting plate; (2) hat-shaped brackets; (2) J-Bolts, 5/16-18 x 2-1/4"; (3) hex nuts, 5/16-18; (3) split lock washers, 5/16"

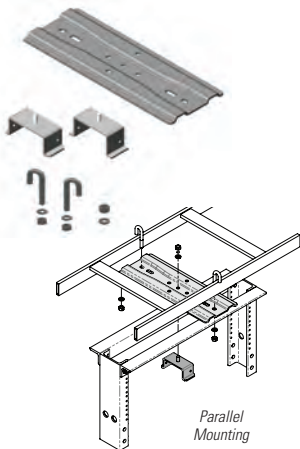

Part Number	Runway Width in (mm)	Plate Material	Shipping Weight lb (kg)
12730-X04	4 (100)	Steel	4 (1.8)
12730-X08	5 to 8 (130 to 200)	Steel	5 (2.3)
12730-X12	9 to 12 (230 to 300)	Steel	5 (2.3)
12730-X18	15 to 18 (380 to 460)	Steel	7 (3.2)
13730-X24	20 to 24 (510 to 610)	Aluminum	4 (1.8)

*X=*color (12730): 1=Gray, 7=Black, E=Glacier White. *X=*color (13730): 1=Gray, 5=Clear, 7=Black, E=Glacier White. Gold and Glacier White kits have gold colored hardware. Other kits have black colored hardware.

6" (150 mm) Channel Rack-To-Runway Mounting Plate

Secures Cable Runway to the top of 6"D (150 mm) Standard Rack. Mounts either parallel or perpendicular to runway.

- Installation Best Practices include Runway Elevation Kit (P/N 10506-XXX)

P/N 12121-XXX consists of:

- (1) mounting plate
- (4) 5/16-18 x 2 1/4" J-bolts
- (4) 5/16-18 hex nuts
- (4) 5/16 split lock washers

P/N 12409-X24 consists of:

- (1) mounting plate
- (2) 5/16-18 x 3 1/4" J-bolts
- (2) 5/16-18 x 2 1/4" J-bolts
- (4) 5/16-18 hex nuts
- (4) 5/16 split lock washers

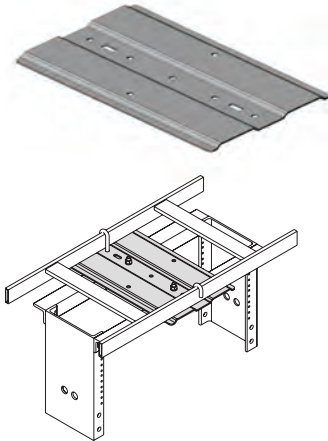

Part Number	Runway Width in (mm)	Plate Material	Shipping Weight lb (kg)
12121-X09	5 to 9 (130 to 230)	Steel	5 (2.3)
12121-X12	9 to 12 (230 to 300)	Steel	5 (2.3)
12121-X18	15 to 18 (380 to 460)	Steel	7 (3.2)
12409-X24	20 to 24 (510 to 610)	Aluminum	5 (2.3)

X=color (12121): 1=Gray, 7=Black, E=Glacier White. X=color (12409): 1=Gray, 5=Clear, 7=Black, E=Glacier White. Gold and Glacier White kits have gold colored hardware. Gray and Black kits have black colored hardware. 12409-X24 adds 1.25" (32 mm) to height of rack.

6" (150 mm) Channel Rack-To-Runway Mounting Plate With Bracket

Secures Cable Runway to the top of 6"D (150 mm) Standard Rack without intruding into valuable mounting space. The combination of the flat plate and hat-shaped bracket form a clamp around the rack's top angles or top bars. Mounts either parallel or perpendicular to the runway.

- Installation Best Practices include Runway Elevation Kit (P/N 10506-XXX)

Kit includes:

- (1) mounting plates
- (2) hat-shaped bracket
- (2) J-Bolts, 5/16-18 x 2-1/4"
- (3) hex nuts, 5/16-18
- (3) split lock washers, 5/16"

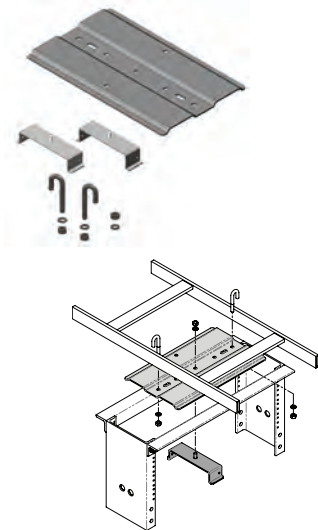

Part Number	Runway Width in (mm)	Plate Material	Shipping Weight lb (kg)
12731-X09	5 to 9 (130 to 230)	Steel	5 (2.3)
12731-X12	9 to 12 (230 to 300)	Steel	5 (2.3)
12731-X18	15 to 18 (380 to 460)	Steel	7 (3.2)
13731-X24	20 to 24 (510 to 610)	Aluminum	5 (2.3)

X=color (12731): 1=Gray, 7=Black, E=Glacier White. X=color (13731): 1=Gray, 5=Clear, 7=Black, E=Glacier White. Gold and Glacier White kits have gold colored hardware. Gray and Black kits have black colored hardware. 13731-X24 adds 1.25" (32 mm) to height of rack.

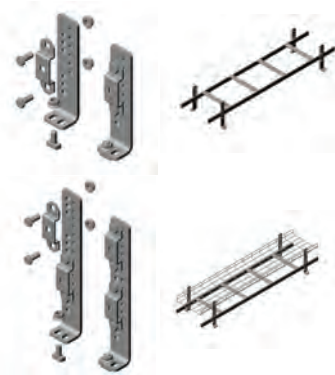

Cable Pathway Elevation Kits for ZetaFrame™ Cabinet

Supports CPI Cable Runway above a continuous row of ZetaFrame Cabinets, providing additional space between the tops of the cabinets and the cable runway and trays.

- Three ranges of incremental elevation.
- Two Tier version supports two levels of cable runway or wire mesh cable tray
- Recommended pathway support span is 5' (1.5 m).
- Attaches to top track of ZetaFrame Cabinet frame. Position pathway front-to-rear on track
- Kit includes (1) pair of elevation brackets, all hardware to attach the brackets to the ZetaFrame Cabinet, and all required hardware to attach Cable Runway to elevation brackets.

Part Number		Description Height in (mm)	Shipping Weight lb (kg)
1 Tier	2 Tier		
60508-X02	60508-X22	2", 2.5", 3"H (50, 64, 75)	3.1 (1.5)
60508-X06	60508-X26	4", 5", 6"H (100, 127, 150)	3.8 (18)
60508-X08	N/A	10", 11", 12"H (250, 280, 300)	5.5 (2.5)

Note: X=Color: 7=Black, E=Glacier White. Shipping weight is for 1 Tier Elevation Kit

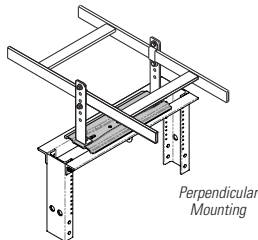
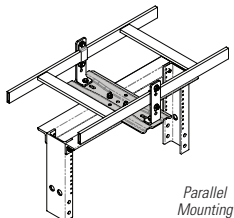

Cable Runway Elevation Kit for Racks, and Cabinets

Supports Cable Runway above a continuous row of CPI Racks of varying heights and provides additional space between the tops of the racks or cabinets and the cable runway, which can create smoother transition of cables.

- Three ranges of incremental elevation
- Can be mounted perpendicular or parallel
- Rack kit includes a single pair of brackets and assembly hardware
- Rack kits attach to the top of the rack with a Rack-To-Runway Mounting Plate (P/N 10595 or 12121, sold separately)
- 60507 Series supports two tiers of pathway
- Compatible with Adjustable Cable Runway

Rack	Shipping Weight lb (kg)	Cabinet	Shipping Weight lb (kg)
2", 2.5" or 3"H (50 mm, 64 mm or 80 mm) Elevation			
10506-X02	2 (0.9)	10506-X12	2 (0.9)
4", 5" or 6"H (100 mm, 130 mm or 150 mm) Elevation			
10506-X06	2 (0.9)	10506-X16	4 (1.8)
10", 11" or 12"H (250 mm, 280 mm or 300 mm) Elevation			
10506-X08	3 (1.4)	10506-X18	5 (2.3)

X=Color: 0=Gold, 1=Gray, 7=Black, E=Glacier White. Gold and Glacier White kits have gold colored hardware. Gray and Black kits have black colored hardware.

60507-X02	2"-3"H (50-75 mm), Pair	3.1 (1.5)
60508-X06	4"-6"H (100-150 mm), Pair	3.8 (18)

Note: X=Color: 7=Black, E=Glacier White.

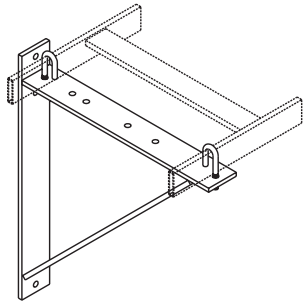

Triangular Support Bracket, Aluminum

Triangular Support Bracket provides wall support for Cable Runway. Made of 1/4" x 2" (6.4 mm x 50 mm) aluminum bar. Load rating is 100 lb (45.4 kg).

- Compatible with Adjustable Cable Runway

Kit includes:

- (1) triangular bracket; (2) 5/16-18 x 2 1/4" J-bolts ; (2) 5/16-18 hex nuts & 5/16 lock washers

Part Number	Runway Widths in (mm)	Shipping Weight lb (kg)
11312-X06	4-6 (100 - 150)	2 (0.9)
11312-X12	6-12 (150 - 300)	3 (1.4)
11312-X18	12-18 (300 - 460)	3 (1.4)

X=color: 1=Gray, 7=Black, E=Glacier White.

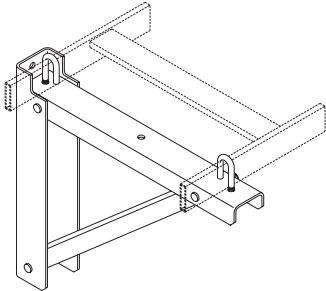

Triangular Support Bracket, Steel

Triangular Support Bracket provides wall support for cable runway. Made of cold-rolled steel. Load rating is 400 lb (181.4 kg).

- Compatible with Adjustable Cable Runway

Kit includes:

- (1) vertical wall-mounting bracket; (1) runway support channel ; (1) angle support channel; (3) clevis pins (5/16" diameter) & cotter pins; (2) 5/16-18 x 2 1/4" J-bolts; (2) 5/16-18 hex nuts & 5/16 lock washers

Part Number	Runway Widths in (mm)	Shipping Weight lb (kg)
11746-X12	4-12 (100-300)	5 (2.3)
11746-X18	9-18 (230-460)	8 (3.6)
11746-X24	9-24 (230-610)	9 (4.1)

X=color: 0=Gold, 1=Gray, 7=Black, E=Glacier White. Gold and Glacier White kits have gold colored hardware. Gray and Black kits have black colored hardware.

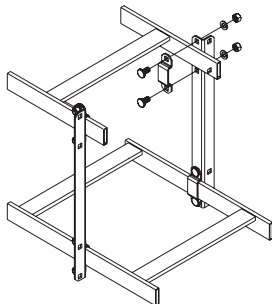

Cable Runway Standoff Support Kit

Allows the attachment of cable runway 12" (300 mm) directly above and either parallel or perpendicular to existing Cable Runway. Each kit consists of the following items: two steel angle pieces, four steel brackets and eight sets of nuts, bolts and washers. The angle pieces are available in Gray, Computer Beige, Black or Gold finish.

- Compatible with Adjustable Cable Runway

Part Number	Description	Shipping Weight lb (kg)
31470-X12	Standoff Support Kit	1 (0.5)

X=color: 0=Gold, 1=Gray, 7=Black, E=Glacier White. Gold, Glacier White kits has gold-colored hardware. Gray and Black kits have black color hardware.

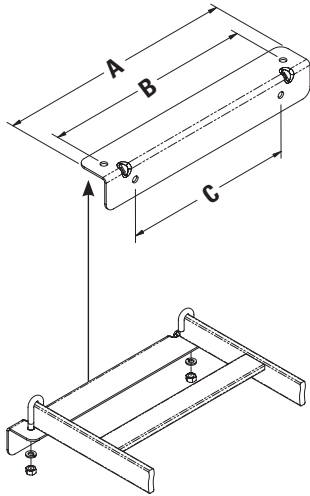

Wall Angle Support Kit, Cable Runway

2" x 2" x .105" (50 mm x 50 mm x 2.67 mm) steel support angle is designed for wall-mounting specific widths of Cable Runway.

- Compatible with Adjustable Cable Runway

Kit includes:

- (1) wall angle; (2) 5/16-18 x 2 1/4" J-bolts ; (2) 5/16-18 hex nuts; (2) 5/16 lock washers

Part Number	Runway Width in (mm)	Dim. A in (mm)	Dim. B in (mm)	Dim. C in (mm)
11421-X04	4 (100)	6 (150)	4.31 (109.5)	4.31 (109.5)
11421-X06	6 (150)	8 (200)	6.31 (160.3)	4 (100.0)
11421-X09	9 (230)	11 (280)	9.31 (236.5)	7 (180.0)
11421-X10	10 (250)	12 (300)	10.21 (261.9)	8 (200.0)
11421-X12	12 (300)	14 (360)	12.31 (312.7)	10 (250.0)
11421-X15	15 (380)	17 (430)	15.31 (388.9)	13 (330.0)
11421-X18	18 (460)	20 (510)	18.31 (465.1)	16 (410.0)
11421-X20	20 (510)	22 (560)	20.31 (515.9)	18 (460.0)
11421-X24	24 (610)	26 (660)	24.31 (617.5)	22 (460.0)
11421-X30	30 (760)	32 (810)	30.31 (769.9)	28 (710.0)

*X=*color: 0=Gold, 1=Gray, 7=Black, E=Glacier White. Gold and Glacier White kits have gold colored hardware. Gray and Black kits have black colored hardware.

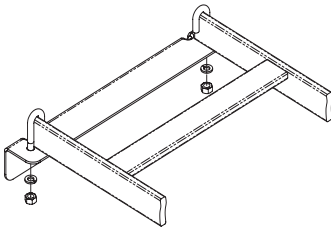

J-Bolt Kit, Cable Runway

To attach Cable Runway to Wall Angle Support, a Wall Support Bracket or to a MegaFrame® Cabinet.

- Compatible with Adjustable Cable Runway

Kit (wall angle/support) consists of:

- (2) 5/16-18 x 2-1/4" J-bolts (11431-001)
- (2) 5/16-18 hex nuts
- (2) 5/16 split lock washers

MegaFrame Kit includes:

- (4) 5/16-18 x 3-1/4" J-bolts
- (4) 5/16" split lock washers
- (4) 5/16-18 hex nuts

Part Number	Description	Shipping Weight lb (kg)
11308-X01	J-Bolt Kit	1 (0.5)
11308-X05	J-Bolt Kit, MegaFrame	1 (0.5)

*X=*color: 0=Gold, 7=Black



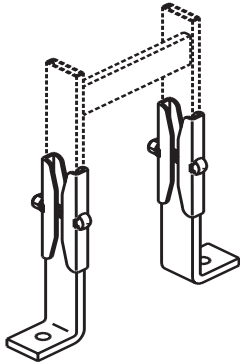

Foot Kit, Cable Runway

To attach and secure Cable Runway to a wall or floor. Foot made of 3/8" x 1-1/2" x 6" H (9.53 mm x 38 mm x 150 mm) steel.

- Compatible with Adjustable Cable Runway

Kit includes:

- (2) cable rack feet
- (4) splice plates
- (2) 3/8-16 x 2 1/4" trimmed round head square neck bolts
- (2) 3/8-16 hex nuts
- (2) 3/8" lock washers

Part Number	Description	Shipping Weight lb (kg)
11309-X01	Foot Kit	4 (1.8)

X=color: 0=Gold, 1=Gray, 7=Black, E=Glacier White. Gold and Glacier White kits have gold colored hardware. Gray and Black kits have black colored hardware.

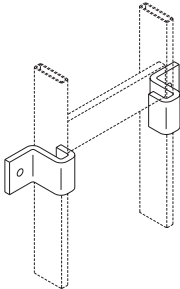

Vertical Wall Brackets

Used to secure Cable Runway with 1-1/2" x 3/8" (38 mm x 9.53 mm) stringers to a wall. Sold in pairs.

- Compatible with Adjustable Cable Runway
- Material is 1/4" x 1-1/2" (6.4 mm x 33 mm) steel
- Gold color over zinc plating or painted
- Wall mounting hardware not included

Part Number	Description in (mm)	Shipping Weight lb (kg)
10608-X01	Runway Wall Brackets (Pair), Gold	1 (0.5)

X=color: 0=Gold, 7=Black, E=Glacier White.

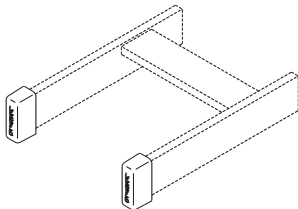

Protective End Caps For Runway

Covers and protects exposed ends of cable runway and auxiliary framing bar and channel. Reduces chances of personal injury and equipment damage.

- Made of fire-retardant flat black colored rubberized material
- Sold in pairs
- Only P/N 10642-001 is compatible with Adjustable Cable Runway

Part Number	Description in (mm)	Shipping Weight lb (kg)
10642-001	For 1-1/2 x 3/8 (38 x 9.53) Stringer	1 (0.5)
10757-001	For 2 x 3/8 (50 x 9.53) Auxiliary Bar	1 (0.5)

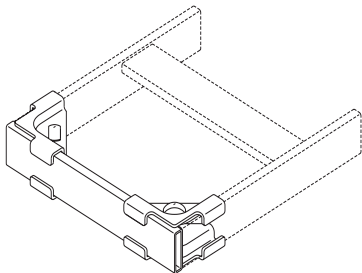

Gold, Computer Beige and Glacier White kits include gold colored hardware. Gray and Black kits include black colored hardware.

End Closing Kit, Cable Runway

Used to close an unspliced end of Cable Runway. Made of 3/8" x 1-1/2" x .065" (9.53 mm x 38 mm x 1.65 mm) thick rectangular steel tubing.

Kit includes:

- Compatible with Adjustable Cable Runway
- (1) end closing bar
- (4) corner clamp plates
- (2) 3/8-16 x 1 3/8" trimmed round head square neck bolts
- (2) 3/8-16 hex nuts

Part Number	Description	Shipping Weight lb (kg)
11700-X04	End Closing Kit, Cable Runway	4 (100)
11700-X05	End Closing Kit, Cable Runway	5 (130)
11700-X06	End Closing Kit, Cable Runway	6 (150)
11700-X09	End Closing Kit, Cable Runway	9 (230)
11700-X12	End Closing Kit, Cable Runway	12 (300)
11700-X15	End Closing Kit, Cable Runway	15 (380)
11700-X18	End Closing Kit, Cable Runway	18 (460)
11700-X20	End Closing Kit, Cable Runway	20 (510)
11700-X24	End Closing Kit, Cable Runway	24 (610)

X=Color: 0=Gold, 1=Gray, 7=Black, E=Glacier White. Gold and Glacier White kits have gold colored hardware. Gray and Black kits have black colored hardware.

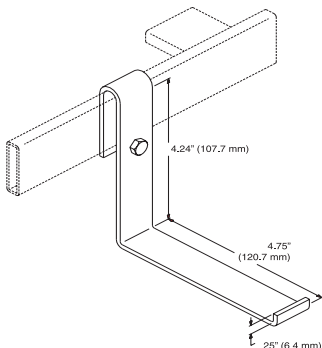

"L" Bracket, Cable Runway

Bracket provides a separate facility for running power conductors or other cables that should be physically separated from main cables.

- Made of 1/8" x 1" (3.18 mm x 30 mm) steel; gold finish/color over zinc plating
- Compatible with Adjustable Cable Runway

Kit includes (1 each):

- Bracket for 1-1/2" stringer; 1/4-20 x 3/4" hex bolt

Part Number	Description	Shipping Weight lb (kg)
11268-001	"L" Bracket	1 (0.5)

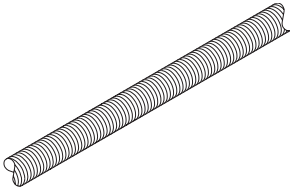

Threaded Drop Rods

Used to support Cable Runway from ceilings.

- Standard threads, various lengths
- Gold chem film over zinc plate finish

Part Number	Description	Shipping Weight lb (kg)
11440-001	3/8-16 UNC-2A rod, 6'L	2 (0.9)
11440-002	5/8-11 UNC-2A rod, 6'L	5 (2.3)
11440-003	3/8-16 UNC-2A rod, 12'L	5 (2.3)
11440-004	5/8-11 UNC-2A rod, 12'L	10 (4.5)
11440-005	5/8-11 UNC-2A rod, 8'L	7 (3.2)
11440-006	5/8-11 UNC-2A rod, 4'L	4 (1.8)
11440-007	5/8-11 UNC-2A rod, 6"L	1 (0.5)
11440-008	5/8-11 UNC-2A rod, 8"L	1 (0.5)
11440-009	5/8-11 UNC-2A rod, 5.5"L	1 (0.5)
11440-012	5/8-11 UNC-2A rod, 1'L	1 (0.5)
11440-024	5/8-11 UNC-2A rod, 2'L	2 (0.9)
11440-036	5/8-11 UNC-2A rod, 3'L	3 (1.4)

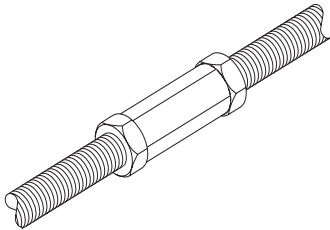

Threaded Rod Coupling Kit

Used to splice two threaded rods end to end.

Part Number	Description	Shipping Weight lb (kg)
10697-001	For 3/8" Rod	3 (1.4)
10697-002	For 5/8" Rod	3 (1.4)

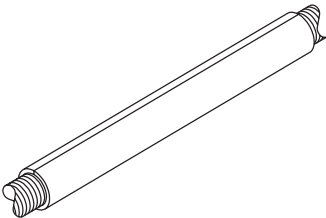

Threaded Rod Cover

Protects cable from damage during installation.

- Made of plastic PVC tubing. Gray I.D. = 0.630" (16 mm)

Part Number	Description	Shipping Weight lb (kg)
11085-001	Threaded Rod Cover, 10 (3)	5 (2.3)

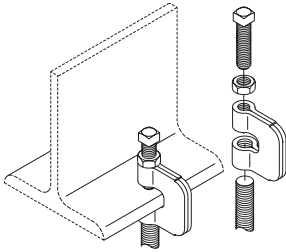

Threaded Rod I-Beam Clamps, Cable Runway

Fastens a 3/8" or 5/8" threaded rod to an I-beam.

- Material is cold-rolled steel
- Finish is gold over zinc plating

Part Number	Description	Shipping Weight lb (kg)
10557-001	For 3/8"-16 Threaded Rod	3 (1.4)
10557-003	For 5/8"-11 Threaded Rod	3 (1.4)

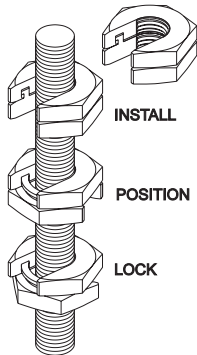

Slip-On® Lock Nut

Used to add a nut to threaded rod without having to thread from the end. Zinc plated. Slip-On® is a registered trademark of Slip-On Lock Nut Co.

Part Number	Description	Shipping Weight lb (kg)
03003-001	3/8"-16 Slip-On Lock Nut	1 (0.5)
03003-002	5/8"-11 Slip-On Lock Nut	1 (0.5)
Size in (mm)	Recommended Load - lb (kg)	Recommended Torque
3/8 (10)	2,000 (907.2)	19-25 ft/lb (26 Nm-34 Nm)
5/8 (16)	5,000 (2268.0)	100-120 ft/lb (135.6 Nm-162.7 Nm)

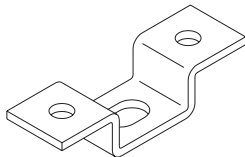

Ceiling Support Bracket

Used to attach threaded rod to ceiling. Hardware is not included.

- Compatible with Adjustable Cable Runway

Part Number	Description	Shipping Weight lb (kg)
11406-001	3/8" (10 mm) or M10 Rod	1 (0.5)
11406-002	5/8" (16 mm) or M16 Rod	1 (0.5)

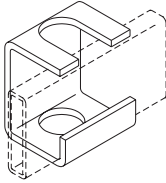

Slotted Support Bracket

Secures threaded rod to Cable Runway.

- Compatible with Adjustable Cable Runway

Kit includes:

- (1) slotted support bracket
- (2) hex nuts
- (2) split lock washers

Part Number	Description in (mm)	Shipping Weight lb (kg)
10607-002	For 3/8" or M10 Rod and 1-1/2 (38) Stringers	1 (0.5)
10607-001	For 5/8" or M16 Rod and 1-1/2 (38) Stringers	1 (0.5)

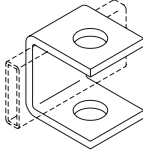

Runway Support Brackets

Used to attach threaded rod to ceiling. Hardware is not included.

- Compatible with Adjustable Cable Runway

Part Number	Description	Shipping Weight lb (kg)
11408-001	For 3/8" (10 mm) or M10 Rod and 1-1/2 (38) Stringers	1 (0.5)
11408-003	For 5/8" (16 mm) or M16 Rod and 1-1/2 (38) Stringers	1 (0.5)

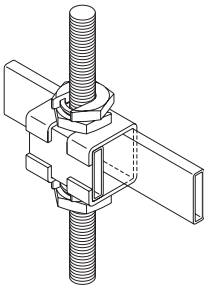

Slip-On® Support Bracket, Cable Runway

Provides easy additions of Cable Runway layers to existing cable racks by allowing support brackets and nuts to slip over drop rod.

- For use with 5/8" (16 mm) threaded rod only
- Finish is gold over zinc plating
- Compatible with Adjustable Cable Runway

Kit includes:

- (2) patented Slip-On nut
- (1) slotted bracket
- (1) retainer piece

Part Number	Description	Shipping Weight lb (kg)
10873-001	Slip-on Support Bracket	1 (0.5)

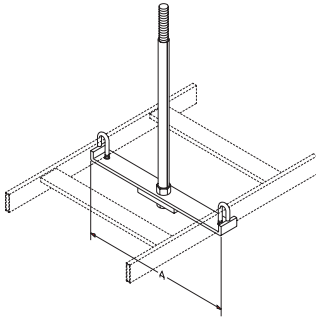

The Cable Runway Center Support Kit is available in sizes to support 6" to 24" W (150 mm to 610 mm) cable runway. Not included: Threaded Rod (P/N 11440-00X) and Ceiling Support Bracket (P/N 11406-002).

Cable Runway Center Support Kit

This kit has been designed to make installation of cable runway in the ceiling even easier by using just a single point of attachment. The center attachment design not only makes installation easy, but also provides quick and simple cable routing with no need to thread the cable between the runway supports. The support kit securely attaches to the cable runway stringer, eliminating possible dislocations.

- Made of steel
- Provides an "open" support system with quick and simple cable routing
- Threaded rod cover protects cable insulation from damage
- Compatible with Adjustable Cable Runway

Kit includes:

- (1) support bracket; (1) reinforcement bar; (2) 5/8-11 hex nuts; (1) 5/8 split lock washers; (1) 12" L (300 mm) threaded rod cover; (1) J-bolt kit (2 J-bolts; 2 nuts; 2 washers)

Part Number	Description Width - in (mm)	Dim. A in (mm)	Shipping Weight lb (kg)
12362-X06	6 (150)	6.56 (166.6)	2 (0.9)
12362-X12	12 (300)	12.56 (319.0)	2 (0.9)
12362-X15	15 (380)	16.20 (411.5)	3 (1.4)
12362-X18	18 (460)	19.20 (487.7)	4 (1.8)
12362-X24	24 (610)	25.20 (640.1)	5 (2.3)

X=color: 0=Gold, 1=Gray, 7=Black, E=Glacier White. Gold and Glacier White kits have gold colored hardware. Gray and Black kits have black colored hardware.

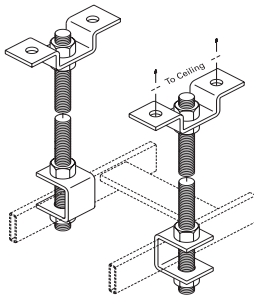

Drawing shows 2 kits

Note: Recommended spacing between ceiling kits is 5" (1.5 m). The ceiling hole diameter for P/N 11310 is .375" (9.5 mm) for 3/8" or M10 rod; .500" (12.7 mm) for 5/8" or M16 rod.

Threaded Ceiling Kit, Cable Runway

Used to suspend Cable Runway from the ceiling. Material is steel, finished with gold over zinc plating.

- Compatible with Adjustable Cable Runway

Kit includes:

- (1) ceiling support bracket
- (1) either 3/8-16 x 6", 5/8-11 x 6", M10 x 2M or M16 x 2M threaded rod
- (1) runway support bracket
- (4) either 3/8-16, 5/8-11, M10 or M16 hex nuts

Part Number	Description	Shipping Weight lb (kg)
11310-001	Threaded Ceiling Kit, 3/8" Rod	3 (1.4)
11310-003	Threaded Ceiling Kit, 5/8" Rod	7 (3.2)
11310-093	Threaded Ceiling Kit, M10 x 2M	7 (3.2)
11310-094	Threaded Ceiling Kit, M16 x 2M	7 (3.2)

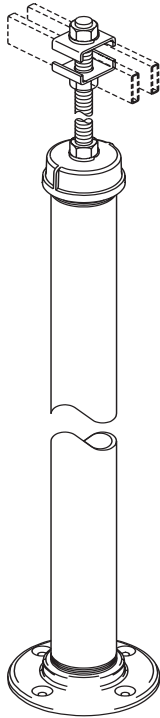

Tall Pipe Stand, Cable Runway

Supports auxiliary framing or Cable Runway from the floor.

- Material is steel
- Compatible with Adjustable Cable Runway

Kit includes:

- (1) floor flange
- (1) appropriate length of 2" (50 mm) pipe
- (1) pipe cap, center drilled and tapped for a 5/8- 11 threaded rod (P/N 11440, not included)
- (3) 5/8-11 hex nuts
- (3) 5/8 split lock washers
- (4) 1/4-20 x 1 1/2" studs
- (4) 1/4-20 concrete anchors
- (4) 1/4-20 hex nuts
- (4) 1/4 Type B washers

Installation also requires:

- (1) grid clamp of appropriate width, See P/N 10609
- (1) 5/8-11 threaded rod of appropriate length, See P/N 11440

Note: Must be securely mounted to floor with included anchor kit.

Also, in the case of attachment to Cable Runway, you may need to use Runway Support Brackets, series 11408 or 10607.

Part Number	Description in (mm)	Overall Height ft (m)	Shipping Weight lb (kg)
10684-X01	2 x 79 (50 x 2010) Tall Pole	7 (2.1)	16 (7.3)
10684-X02	2 x 85 (50 x 2160) Tall Pole	7.6 (2.3)	18 (8.2)
10684-X03	2 x 91 (50 x 2310) Tall Pole	8 (2.4)	20 (9.1)
10684-X04	2 x 103 (50 x 2620) Tall Pole	9 (2.7)	24 (10.9)

X=color: 1=Gray, 7=Black, Glacier White.

Spanner Kit, Auxiliary Framing Channel/Cable Runway

Used to attach Cable Runway to auxiliary framing.

- Gold over zinc plating, sold individually
- Compatible with Adjustable Cable Runway

Kit includes:

- (1) Spanner Bolt; (1) 1/2-13 split lock washer; (1) 1/2-13 hex nut

Part Number	Description Nominal Size and Length	Shipping Weight lb (kg)
10702-001	1/2-13 x 4-3/8"	1 (0.5)
10702-002	1/2-13 x 4-7/8"	1 (0.5)

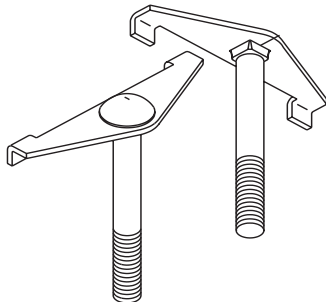

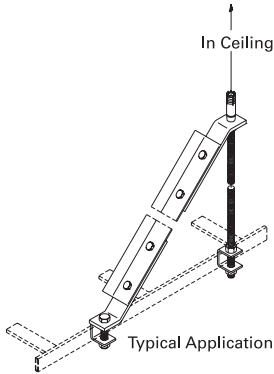

Earthquake Bracing Kits

Stabilizes Cable Runway hung from threaded rods. Material is 2" x 3/8" (50 mm x 9.53 mm) steel with gold over zinc plating.

Single Kit consists of:

- (2) steel bars (45° angle)
- (4) 1/2-13 x 1 1/4" hex nuts & cap screws
- (4) 1/2" split lock washers

Double Kit consists of:

- (2) steel bars (45° angle)
- (1) "V" steel bar
- (8) 1/2-13 x 1 1/4" hex cap screws
- (8) 1/2-13 hex nuts
- (8) 1/2" split lock washers

Installation will require (not included):

- Threaded rod and runway attachment hardware
- (1) 2" x 2" x 3/16" (50 mm x 50 mm x 4.763 mm) steel angle of appropriate length. See P/N 11420 (angle must be trimmed to proper length and drilled during installation)

Part Number	Description	Shipping Weight lb (kg)
10695-001	Single Earthquake Brace	8 (3.6)
10696-001	Double Earthquake Brace	14 (6.4)

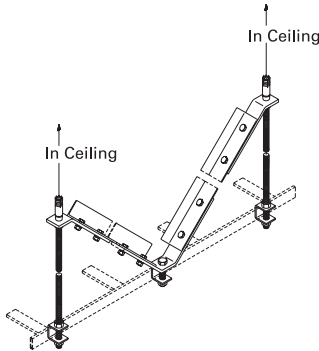

Installation may also require (not included):

For concrete ceiling:

- 5/8-11 concrete anchors
- 5/8-11 x 3 1/2" studs
- 5/8-11 hex nuts
- 5/8" split lock washers

For secondary structure:

- 5/8-11 threaded rod
- Grid Clamp Kits
- 5/8-11 hex cap screws
- 5/8-11 hex nuts
- 5/8" split lock washers

Note: Seismic installation requirements should be approved by a licensed structural engineer.

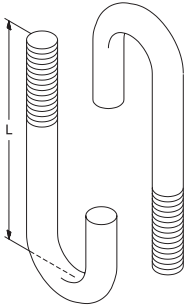

J-Bolts (Hook Bolt, Round Bend), Auxiliary Framing Channel/Cable

Used to bolt Cable Runway (11431 series only), auxiliary framing channels and/or bars together.

- Gold over zinc and black zinc plate finish
- Includes nut and split lock washer
- Commercial grade, kits sold individually
- Only P/N Series 11431-XXX is compatible with Adjustable Cable Runway

Part Number	Nominal Size	Length	Opening	Shipping Weight lb (kg)
11430-X01	1/4-20	1 3/4"	7/32	1 (0.5)
11430-X02	1/4-20	2"	7/32	1 (0.5)
11431-X01	5/16-18	2 1/4"	7/16	1 (0.5)
11431-X02	5/16-18	2 3/4"	7/16	1 (0.5)
11431-X03	5/16-18	3 1/4"	7/16	1 (0.5)
11431-X04	5/16-18	3 3/4"	9/32	1 (0.5)

X=Color: 0=Gold, 7=Black

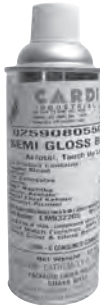

12 oz (340 g)
pressurized can

Touch-Up Paint In Spray Can

Air dry lacquer for touching up finish. Matches color and gloss of CPI's textured paint; air dries to hard finish in minutes.

- Compatible with Adjustable Cable Runway

Part Number	Description oz (g)	Shipping Weight lb (kg)
25400-X00	12 (340) Spray Can	2 (0.9)

X=Color: 1=Gray, 7=Black, E=Glacier White.



1 oz (30 g) bottle
with applicator

Touch-Up Paint In Bottle

Air dry waterborne paint for touching up finish. Matches color and gloss of CPI's textured paint.

- Compatible with Adjustable Cable Runway

Part Number	Description oz (g)	Shipping Weight lb (kg)
25401-X00	1 (30) Bottle	2 (0.9)

X=Color: 1=Gray, 7=Black, E=Glacier White.

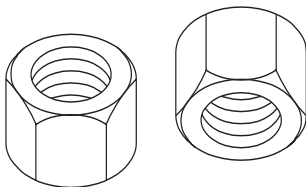

Hex Nuts

- Zinc plate or gold chem (yellow zinc plate) finish
- Sold in packs of 100

Part Number Pack of 100	Nominal Size	Finish	Shipping Weight lb (kg)
20142-171	1/4-20	Gold	1 (0.5)
20017-171	1/4-20	Zinc Plated	1 (0.5)
20142-181	5/16-18	Gold	1 (0.5)
20017-181	5/16-18	Zinc Plated	1 (0.5)
20142-191	3/8-16	Gold	2 (0.9)
20017-191	3/8-16	Zinc Plated	2 (0.9)
03001-101	1/2-13	Gold	4 (1.7)
20142-121	5/8-11	Gold	7 (3.3)

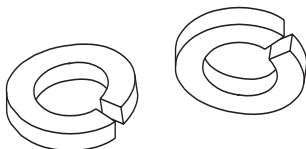

Split Lock Washers

- Zinc plate or gold chem (yellow zinc plate) finish
- Sold in packs of 100

Part Number Pack of 100	Nominal Size	Finish	Shipping Weight lb (kg)
04003-102	1/4"	Gold	1 (0.5)
20015-170	1/4"	Zinc Plated	1 (0.5)
20141-180	5/16"	Gold	1 (0.5)
20015-180	5/16"	Zinc Plated	1 (0.5)
20141-190	3/8"	Gold	1 (0.5)
20015-190	3/8"	Zinc Plated	1 (0.5)
20141-110	1/2"	Gold	1 (0.5)
04003-101	5/8"	Gold	1 (0.5)

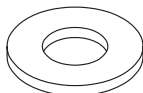

Washers: Type A Plain

- Zinc plate or gold chem (yellow zinc plate) finish
- Sold in packs of 100

Part Number Pack of 100	Nominal Size	Finish	Shipping Weight lb (kg)
20283-112	5/16" Wide	Zinc Plated	1 (0.5)
04002-102	3/8" Wide	Gold	1 (0.5)
20283-113	3/8" Narrow	Zinc Plated	1 (0.5)
04002-101	5/8" Wide	Gold	1 (0.5)
20283-122	5/8" Wide	Zinc Plated	1 (0.5)

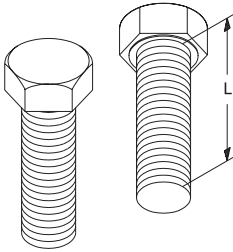

Hex Cap Bolts

Also called Washer Faced Hex Cap Screws.

- Commercial grade
- Zinc plate or gold chem (yellow zinc plate) finish
- Sold in packs (quantities vary)

Part Number (Pack)	Nominal Size	Length	Finish	Pack Qty	Shipping Weight lb (kg)
20290-106	1/4-20	3/4"	Zinc Plated	100	2 (0.8)
20290-118	1/4-20	2-1/4"	Zinc Plated	100	4 (1.8)
20290-216	5/16-18	2"	Zinc Plated	100	6 (2.5)
20290-307	3/8-16	7/8"	Zinc Plated	100	5 (2.1)
02004-101	3/8-16	1-1/4"	Gold	100	6 (2.5)
02004-102	1/4-20	1-1/4"	Gold	100	3 (1.1)
02004-103	1/2-13	1-1/2"	Gold	100	12 (5.3)
02004-104	3/8-16	1-1/2"	Gold	100	6 (2.5)
02004-105	1/2-13	1-3/4"	Gold	100	13 (5.9)
02004-056	5/8-11	1-1/4"	Gold	50	9 (3.9)
02004-057	5/8-11	3-1/4"	Gold	25	8 (3.8)

Note: Shipping weights are for Pack Quantity. Please note pack quantity column.

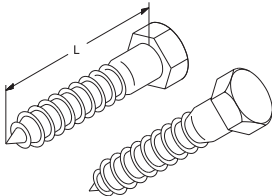

Hex Lag Screw

Used to install racks onto wood or other soft surfaces.

- Gold chem (yellow zinc plate) over zinc plate finish
- Sold in packs (quantities vary)

Part Number (Pack)	Nominal Size	Length	Pack Qty	Shipping Weight lb (kg)
02006-051	1/2-6	2"	50	6 (2.6)
02006-052	5/8-5	2"	50	11 (4.8)
02007-104	1/4-10	2"	100	3 (1.4)
20098-132	3/8-7	2"	100	7 (3.0)

Note: Shipping weights are for Pack Quantity. Please note pack quantity column.

SECTION 6

INDUSTRIAL ENCLOSURES

RMR® Modular Enclosure	6-3
RMR Swing Wall-Mount Enclosure	6-12
RMR Fixed Wall-Mount Enclosure	6-14
RMR Wall-Mount Accessories	6-16
RMR Floor-Mount Enclosure	6-20
RMR Free-Standing Enclosure	6-22
RMR Standard Enclosure	6-26
RMR Thermal Accessories	6-31
RMR Sealing Accessories	6-34



*Learn about CPI's Standard Limited Warranty and Extended Limited Warranties.
See page vii for details.*

INDUSTRIAL ENCLOSURES

Use industrial enclosures on every machine, robot and work cell to protect the industrial computers, motor controls, valve controls and instrumentation that control these systems.

CPI offers a wide range of environmentally rated NEMA Type 12 or IP 55 industrial enclosures that protect equipment from dust and dripping non-corrosive liquids or NEMA Type 4 or IP 66 industrial enclosures that protect equipment in process environments and wet spaces.

Enclosures are available in multiple sizes and designs with various levels of protection against particulate and liquid penetration and can attach to the machine or architectural structure. CPI offers a complete solution of enclosures for indoor spaces in both conditioned or unconditioned areas with a range of accessories for cable, power and thermal management, and remote monitoring.

Where Can I Learn More?

To learn more about CPI's Industrial Enclosures, or to find additional part numbers not listed in this catalog, please visit our website, chatsworth.com.

Related Tools:

Use these tools, under the Resources tab on chatsworth.com, to simplify your planning, selection, order and purchase of CPI's Industrial Enclosures

- Product Designer

Featured Product:

RMR® Modular Enclosure

RMR Modular Enclosure is an advanced industrial enclosure engineered to protect equipment with cutting-edge sealing technology, certified ingress protection ratings, and multiple equipment mounting options to support IT equipment, automation electronics and electrical controls and instrumentation in nonhazardous indoor locations.



Cabinet Includes:

- (1) Modular enclosure frame
- (4) Equipment mounting rails or (1) Equipment mounting plate
- (1) Top Panel
- (2) Side Panels
- (1) Front Door
- (1) Rear Door or Fixed Rear Panel
- (1) Bottom Panel
- Optional Filter Fan or Cooling Unit

RMR Modular Enclosure

RMR Modular Enclosure is an advanced Industrial Distribution Frame (IDF)/ Factory Edge enclosure engineered to protect equipment with cutting-edge sealing technology, certified ingress protection ratings, and multiple equipment mounting options to support IT equipment, automation electronics and electrical controls and instrumentation in nonhazardous indoor locations.

The RMR Modular Enclosure features a welded, roll-formed frame that is punched with attachment points on all interior surfaces to support an array of panel and equipment installations. The frame may be outfitted with a variety of mounting plates or 19" EIA (482.6 mm) wide equipment rails. Mounting plates are available in quarter-, half- and full-height options.

- Provides equipment with NEMA Type 12 and IP 55 rated protection against ingress of solid foreign objects and dripping noncorrosive liquids, using advanced formed-in-place foam gasket technology at each panel and cable entry point
- Supports airflow and cooling options specially certified for industrial applications to maintain equipment cooling requirements outside of normal IT settings and equipment rooms
- Features unique drop-in frame attachment hardware, allowing quick and secure mounting of plates, rails and accessories at any point along the frame
- Allows a complete enclosure solution to be configured under a single part number, including the exact size frame, mounting system, doors, panel work and ventilation that you require
- Available with factory modifications –change size or color, and add openings for connections, controls and HMI

Cabinet Specifications:

- Heights:
 - 24U, 47.2" (1200 mm)
 - 42U, 78.7" (2000 mm)
 - 45U, 82.7" (2100 mm)
 - 47U, 86.6" (2200 mm)
- Widths: 23.6" (600 mm) and 31.5" (800 mm)
- Depths: 23.6" (600 mm), 31.5" (800 mm), 39.4" (1000 mm) and 47.2" (1200 mm)
- Equipment Space 19" EIA (482.6 mm) Equipment Mounting Rails (2 pairs) or (1) Full-Height Rear Mounting
- Frame:
 - Welded, roll-formed steel frame; modular construction
 - Punched with attachment pattern, 0.98" (25 mm) increments
 - Drop-in attachment hardware provides quick, secure, bonded accessory

Certifications:

- NEMA Type 12 and IEC 60529, IP 55

All Enclosures are:

- UL Listed, Industrial Control Panel Enclosures, Type 12, File Number NITW.E473128
- UL Listed, Industrial Control Panel Enclosures for Canada, Type 12, File NITW7. E473128

Enclosures without filter fans or air conditioners are:

- UL Classified, Degrees of Protection by Enclosures Certified to IEC Publication, E0FI.E486325
- RoHS, REACH

Use the part number matrix below to configure a RMR Modular Enclosure. Choose the **Height**, **Width**, **Depth**, **FR**ame Style, **FR**ont Door, **RR**ear Door, **SD**ide Panel, **L**atch, **C**olor, **B**ottom Panel and **T**op Panel. **Example Cabinet Part Number: A1-11AA-1121-G11.**

A	1	-	H	W	D	FR	-	FD	RD	SP	L	-	C	BP	TP
1. Type															
Modular		1													
2. Height															
U	in	mm													
24	47.2	1200	1												
42	78.7	2000	2												
45	82.7	2100	3												
47	86.6	2200	4												
3. Width															
in	mm														
23.6	600	1													
31.5	800	2													
4. Depth															
in	mm														
23.6	600	A													
31.5	800	B													
39.4	1000	C													
47.2	1200	D													
5. Frame Style															
Multi-Mount (Square-Punched) Rails, 2 Pair, 19" EIA (482.6 mm)														A	
Multi-Mount (Square-Punched) Rails, 2 Pair, 19" EIA (482.6 mm) with Front-To-Rear Horizontal Support Slides														B	
Full-Height Mounting Plate Assembly with Lower Support Rails														C	
6. Front Door															
Single Solid Metal Door														1	
Single Metal Door with Window														2	
Intake Door Assembly with Filter Fan, 7" (177 mm), 65 CFM (110 CMH), 115 VAC														3	
Intake Door Assembly with Filter, 7" (177 mm)														4	
Intake Door Assembly with Filter Fan, 11.5" (291 mm), 560 CFM (351 CMH), 115 VAC														5	
Intake Door Assembly with Filter, 11.5" (291 mm)														6	
Intake Door Assembly with Filter Fan, 7" (177 mm), 65 CFM (110 CMH), 230 VAC														7	
Intake Door Assembly with Filter Fan, 11.5" (291 mm), 560 CFM (951 CMH), 230 VAC														8	
AC Door Assembly with Cooling Unit, 3000-4000 Btu/hr (879-1172 W), 115 VAC														9	
7. Rear Door															
1 Single-Sided Metal Door															
2 Fixed Rear Metal Panel (no hinges, no latch)															
3 Exhaust Door Assembly with Filter Fan, 7" (177 mm), 65 CFM (110 CMH), 115 VAC															
4 Exhaust Door Assembly with Filter Fan, 11.5" (291 mm), 560 CFM (951 CMH), 115 VAC															
5 Exhaust Door Assembly with Filter Fan, 7" (177 mm), 65 CFM (110 CMH), 230 VAC															
6 Exhaust Door Assembly with Filter Fan, 11.5" (291 mm), 560 CFM (951 CMH), 230 VAC															
7 Exhaust Door Assembly with Filter, 7" (177 mm)															
8 Exhaust Door Assembly with Filter, 11.5" (291 mm)															
8. Side Panels															
0 None															
1 Single Solid Side Panel Assembly, (Qty. 1)															
2 Single Metal Side Panel Assembly, (Qty. 2)															
3 Intake Side Panel Assembly with Filter Fan, 7" (177 mm), 65 CFM (110 CMH), 115 VAC; Right. Exhaust Side Panel Assembly with Filter, 7" (177 mm); Left															
4 Intake Side Panel Assembly with Filter Fan, 11.5" (291 mm), 560 CFM (951 CMH), 115 VAC; Right. Exhaust Side Panel Assembly with Filter, 11.5" (291 mm); Left															
5 Intake Side Panel Assembly with Filter Fan, 7" (177 mm), 65 CFM (110 CMH), 230 VAC; Right. Exhaust Side Panel Assembly with Filter, 7" (177 mm); Left															
6 Intake Side Panel Assembly with Filter Fan, 11.5" (291 mm), 560 CFM (951 CMH), 230 VAC; Right. Exhaust Side Panel Assembly with Filter, 11.5" (291 mm); Left															
7 AC Side Panel Assembly with Cooling Unit, 5000-7000 Btu/hr (1465-2051 W), 115 VAC; Right. Single Metal Side Panel Assembly; Left															
8 Intake Side Panel Assembly with Filter, 11.5" (291 mm); Right. Intake Side Panel Assembly with Filter, 11.5" (291 mm); Left, Use with Top Panel Fan															
9. Latch															
1 Double Bit Latch Assembly															
2 T Handle Latch Assembly with CH751 Keyed Lock															
10. Color															
C Black															
G Hammer Gray RAL 7035															
11. Bottom Panel															
1 Solid Bottom															
2 With Removable Gland Plates															
12. Top Panel															
1 Solid Metal Panel															
2 Gland Panel															
3 Exhaust Panel with Filter Fan 11.5" (291 mm), 441 CFM (749 CHM), 115 VAC															

Specifications/Ordering Notes:

1. Height, Widths, Depths: See tables below for detailed dimensions.
6. Front Doors: Intake Filter Fans and Intake Filters are located on the bottom half of the door, Cooling Unit is centered on the door. When using fans, there should be one intake and one exhaust of the same size. Recommended configuration is intake filter fan and exhaust filter. If Intake Door Assembly is selected for the Front Door, select an Exhaust Door Assembly for the Rear Door with the same size Filter or Filter Fan. If AC Door Assembly is selected, select a Solid Metal Door or a Fixed Rear Metal Panel for the Rear Door and Metal Side Panel Assemblies.
7. Rear Doors: Exhaust Filter Fans and Filters are located on the top half of the door. When using fans, there should be one intake and one exhaust of the same size. Recommended configuration is intake filter fan and exhaust filter. If an Exhaust Door Assembly is selected for the Rear Door, select an Intake Door Assembly for the Front Door with the same size filter or filter fan.
8. Side Panels: Omit Side Panels when buying cabinets. Use Side Panel Assemblies with Filter Fans or Cooling Units with solid front and rear doors. Use Side Panel Assembly with Filters only with Top Panel Fan Kit.

For the full line of enclosure configurations, use the RMR Product Designer at chatsworth.com/product-designer.



Equipment Mounting Rails

Equipment Mounting Rails attach directly to frame of the enclosure or to optional front-to-rear horizontal support slides, and support 19" EIA (482.6 mm) rack-mount equipment. Equipment Mounting Rails can be ordered with the enclosure.

- Adjustable-depth, support 19" EIA (482.6 mm) rack-mount equipment
- Universal (vertical) hole pattern, 1U are 1.75" H (44.45 mm)
- U are marked and numbered on the mounting rail
- 12-24 tapped for screws or multi-mount (square-punched) for cage nuts
- Electrically bonded to the enclosure frame
- Optional Front-to-Rear Horizontal Slides available (includes six slides)

Multi-Mount (Square Punched) Rails for RMR Modular Enclosure				
Part Number Width - in (mm)		Enclosure Height in (mm)	Rack-Mount Spaces (U)	Shipping Weight lb (kg)
23.6 (600)	31.5 (800)			
37771-X01	37772-X01	47.2 (1200)	24	19 (8.7)
37771-X03	37772-X03	78.7 (2000)	42	30 (13.7)
37771-X04	37772-X04	82.7 (2100)	45	31 (14.1)
37771-X05	37772-X05	86.6 (2200)	47	33 (15.0)

Tapped #12-24 Equipment Rails for RMR Modular Enclosure				
Part Number Width - in (mm)		Enclosure Height in (mm)	Rack-Mount Spaces (U)	Shipping Weight lb (kg)
23.6 (600)	31.5 (800)			
37774-X01	37775-X01	47.2 (1200)	24	20 (9.1)
37774-X03	37775-X03	78.7 (2000)	42	31 (14.1)
37774-X04	37775-X04	82.7 (2100)	45	32 (14.6)
37774-X05	37775-X05	86.6 (2200)	47	33 (15.0)

X=Color: C=Black, G=Hammer Gray. Shipping weight is for 800 mm wide models.

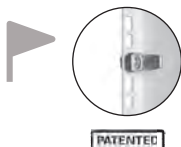

*Clik-Nut® cage nuts make installation time quick and easy.
Go to page 1-38 for ordering information.*

Enclosure Plinth Base

Plinth Base is a structural steel mounting base that creates a lift, which can be used to service and route cables through the bottom panel of the enclosure.

- 4" H (100 mm) or 8" H (200 mm) lift options
- Features kick plates that surround the base of the enclosure
- Includes: Metal structure and assembly hardware

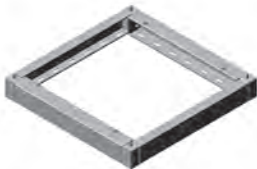

Part Number Plinth Height - in (mm)		Width in (mm)	Depth in (mm)	Shipping Weight lb (kg)
4 (100)	8 (200)			
37830-X03	37830-X21	23.6 (600)	23.6 (600)	40 (18.2)
37830-X05	37830-X23	23.6 (600)	31.5 (800)	44 (20.0)
37830-X07	37830-X25	23.6 (600)	39.4 (1000)	48 (21.8)
37830-X09	37830-X27	23.6 (600)	47.2 (1200)	52 (23.6)
37830-X12	37830-X30	31.5 (800)	23.6 (600)	44 (20.0)
37830-X14	37830-X32	31.5 (800)	31.5 (800)	48 (21.8)
37830-X16	37830-X34	31.5 (800)	39.4 (1000)	52 (23.6)
37830-X18	37830-X36	31.5 (800)	47.2 (1200)	56 (25.5)

X=color: C=Black, G=Hammer Gray. Shipping weights are for 8" (200 mm) plinth height.

Cable Lashing Bracket

Cable Lashing Bracket creates a simple, separate vertical pathway for a small bundle of cables and has multiple slots for straps or tie wraps to secure cables to the bracket.

- Attaches to the frame, adjusts in depth independent of the mounting rails
- Bracket is 1.6"W (41 mm)
- Includes: Brackets, installation hardware; order cable ties separately



Part Number	Description	Shipping Weight lb (kg)
37800-X01	47.2 (1200)	7 (3.2)
37800-X03	78.7 (2000)	9 (4.1)
37800-X04	82.7 (2100)	9 (4.1)
37800-X05	86.6 (2200)	9 (4.1)

X=color: C=Black, G=Hammer Gray.

Finger Cable Manager

Finger Cable Manager is a T-shaped cable guide that creates a pathway for cables next to the 19" EIA (482.6 mm) equipment mounting rails and guides cables into each U space. Wider configurations for 31.5"W (800 mm) enclosures also feature a protective cover.

- Attaches to and adjusts with mounting rails
- Passes up to 24 cables per U space through openings on Short Finger Cable Manager
- Hinged cover on wider configurations, 31.5"W (800 mm) enclosures, snaps closed to secure cables
- Includes: Finger Cable Manager, cover (on wider managers) and installation hardware



37850 Shown



37860 Shown

Short Finger Cable Manager (for use on 19" EIA Rails)

Part Number Width - in (mm)		Enclosure Height in (mm)	Rack-Mount Space (U)	Shipping Weight lb (kg)
23.6 (600)	31.5 (800)			
37850-X01	37860-X01	47.2 (1200)	24	14 (6.4)
37850-X03	37860-X03	78.7 (2000)	42	16 (7.3)
37850-X04	37860-X04	82.7 (2100)	45	21 (9.6)
37850-X05	37860-X05	86.6 (2200)	47	22 (10.0)

Short Finger Cable Manager (for use on 19" EIA Rails with Horizontal Support Slides)

Part Number Width - in (mm)		Enclosure Height in (mm)	Rack-Mount Space (U)	Shipping Weight lb (kg)
23.6 (600)	31.5 (800)			
37865-X01	37860-X01	47.2 (1200)	24	8 (3.7)
37865-X03	37860-X03	78.7 (2000)	42	10 (4.6)
37865-X04	37860-X04	82.7 (2100)	45	11 (5.0)
37865-X05	37860-X05	86.6 (2200)	47	11 (5.0)

X= Color; C=Black, G=Hammer Gray. Shipping weights are for 800 mm wide enclosures.

P/N 3780-XXX can be used with Horizontal Support Slides.

Dual PDU Bracket

Full-Height Dual PDU Mounting Bracket supports two vertical PDUs side-by-side and has multiple slots for CPI Saf-T-Grip Straps or tie wraps to secure cords to the bracket.

- Attaches to the frame, adjusts in depth independent of the mounting rails
- Dual bracket is 4.8"W (121 mm) and supports (2) PDUs up to 2.2"W (51 mm) side-by-side
- Includes: Brackets, installation hardware

Part Number	Description	Shipping Weight lb (kg)
37808-X03	Full-Height, for 78.7"H (2000 mm)	12 (5.5)
37808-X04	Full-Height, for 82.7"H (2100 mm)	13 (5.9)
37808-X05	Full-Height, for 86.6"H (2200 mm)	13 (5.9)
37809-X01	Half-Height, for 47.2"H (1200 mm)	10 (4.6)

X=color; C=Black, G=Hammer Gray.



Ring Cable Manager

Ring Cable Manager is a ring-shaped cable guide that creates a separate vertical pathway for cables, independent of the equipment mounting rails.

- Attaches to the frame, adjusts in depth independent of the mounting rails
- Rings have an opening on the front for easy addition or removal of cables
- Includes: Brackets, rings and installation hardware
- Material: Steel brackets, plastic rings

Part Number	Enclosure Height in (mm)	Plate Width in (mm)	Shipping Weight lb (kg)
37801-X01	37802-X01	47.2 (1200)	11 (5.0)
37801-X03	37802-X03	78.7 (2000)	14 (6.4)
37801-X04	37802-X04	82.7 (2100)	14 (6.4)
37801-X05	37802-X05	86.6 (2200)	14 (6.4)

X=Color, C=Black, G=Hammer Gray. Shipping weights are for 800 mm wide.

Short Ring Cable Manager

Short Ring Cable Manager includes a set of four 7U high brackets that create a pathway for cables next to the 19" EIA (482.6 mm) equipment mounting rails.

- Attaches to and adjusts with mounting rails
- Brackets have slots for securing cable bundles with Saf-T-Grips or tie wraps
- Rings have an opening on the front for easy addition or removal of cables
- Includes: Brackets, rings and installation hardware

Part Number	Shipping Weight lb (kg)
37803-X01	10 (4.6)

X=Color, C=Black, G=Hammer Gray.

Quarter-Height Mounting Plate

Quarter-Height Mounting Plates are solid metal panels that can be mounted in multiple orientations—front-to-rear or side-to-side—directly to the uprights of the frame. The 23.6"W (600 mm) plates can also be mounted directly to 19" EIA square-punched or threaded rails.

Part Numbers				Plate Size Height in (mm)	Plate Size Width in (mm)	
Enclosure Depth or Width - in (mm)						
23.6 (600)	31.5 (800)	39.4 (1000)	47.2 (1200)	Height in (mm)		
37842-X14	37842-X26	37842-X38	37842-X50			70.9 (1800)
37842-X15	37842-X27	37842-X39	37842-X51	78.7 (2000)	18.5 (470)	*
37842-X16	37842-X28	37842-X40	37842-X52	82.7 (2100)	19.4 (493)	*
37842-X17	37842-X29	37842-X41	37842-X53	86.6 (2200)	20.4 (519)	*

*Calculate plate width by subtracting approximately 3.0" (75 mm) from enclosure depth or width; for example, the plate size width for a 23.6"W (600 mm) enclosure is approximately 20.6"W (525 mm). *Shipping weights vary by part number: 18 to 73 lb (8.2 to 33.2 kg).

X=Color, C=Black, G=Hammer Gray.



Half-Height Mounting Plate

Half-Height Mounting Plates are solid metal panels that can be mounted in multiple orientations—front-to-rear or side-to-side—directly to the uprights of the frame. The 23.6" W (600 mm) plates can also be mounted directly to 19" EIA square punched or threaded rails.

Part Numbers				Height in (mm)	Plate Size Height in (mm)	Plate Size Width in (mm)
Enclosure Depth or Width - in (mm)						
23.6 (600)	31.5 (800)	39.4 (1000)	47.2 (1200)			
37840-X13	37840-X25	37840-X37	37840-X49	47.2 (1200)	31.1 (536)	*
37840-X15	37840-X27	37840-X39	37840-X51	78.7 (2000)	78.4 (1992)	*
37840-X16	37840-X28	37840-X40	37840-X52	82.7 (2100)	82.3 (2091)	*
37840-X17	37840-X29	37840-X41	37840-X53	86.6 (2200)	86.3 (2193)	*

*Calculate plate size width by subtracting approximately 3.0" (75 mm) from enclosure depth or width; for example, the plate size width for a 23.6" W (600 mm) enclosure is approximately 20.6" W (525 mm). *Shipping weights vary by part number: 18 to 73 lb (8.2 to 33.2 kg).
X=Color; C=Black, G=Hammer Gray.



Full-Height Mounting Plate Assembly

Full-Height Mounting Plates are solid metal panels that are installed in a side-to-side orientation of the enclosure frame. Mounting panels can be adjusted in depth by 1" (25 mm) increments. Full-Height Mounting Plate Assembly with Lower Support Rails can be ordered with the enclosure.

Part Numbers for 23.6" W (600 mm) Enclosures					Height in (mm)	Plate Size Height in (mm)	Plate Size Width in (mm)
Enclosure Depth - in (mm)							
23.6 (600)	31.5 (800)	39.4 (1000)	47.2 (1200)				
37780-X13	37780-X25	37780-X37	37780-X49	47.2 (1200)	46.9 (1192)	22.9 (582)	
37780-X15	37780-X27	37780-X39	37780-X51	78.7 (2000)	77.4 (1992)	22.9 (582)	
37780-X16	37780-X28	37780-X40	37780-X52	82.7 (2100)	82.3 (2091)	22.9 (582)	
37780-X17	37780-X29	37780-X41	37780-X53	86.6 (2200)	86.3 (2193)	22.9 (582)	

Part Numbers for 31.5" W (800 mm) Enclosures					Height in (mm)	Plate Size Height in (mm)	Plate Size Width in (mm)
Enclosure Depth - in (mm)							
23.6 (600)	31.5 (800)	39.4 (1000)	47.2 (1200)				
37780-X67	37780-X79	37780-X91	37780-XA4	47.2 (1200)	46.9 (1192)	30.8 (783)	
37780-X69	37780-X81	37780-X93	37780-XA6	78.7 (2000)	78.4 (1992)	30.8 (783)	
37780-X70	37780-X82	37780-X94	37780-XA7	82.7 (2100)	82.3 (2091)	30.8 (783)	
37780-X71	37780-X83	37780-X95	37780-XA8	86.6 (2200)	86.3 (2193)	30.8 (783)	

X=Color; C=Black, G=Hammer Gray. Shipping Weights vary by part number: 47 to 107 lb (21.4 to 48.6 kg).

Full-Height Baying Mounting Plate

Full-Height Baying Mounting Plates are installed between two Full-Height Mounting Plates when enclosures are bayed (attached side-by-side). This creates a continuous mounting surface, connecting the two Full-Height Mounting Plates.

Part Number	Enclosure Height in (mm)	Plate Width in (mm)	Shipping Weight lb (kg)
37787-X01	47.2 (1200)	4.1 (104)	11 (5.0)
37787-X03	78.7 (2000)	4.1 (104)	15 (6.9)
37787-X04	82.7 (2100)	4.1 (104)	16 (7.3)
37787-X05	86.6 (2200)	4.1 (104)	16 (7.3)

Bracket Kit for Inset Mount of Full-Height Baying Mounting Plate

Bracket Kit is an alternate method for mounting the Full-Height Mounting Plate. It positions the plate at the very back of the enclosure in a fixed position inset into the rear opening of the frame.

Part Number	Shipping Weight lb (kg)
37777-X01	6 (2.8)

X=color: C=Black, G=Hammer Gray.

Hardware Kits

Hardware Kits are used to attach plates, rails and accessories to the RMR Modular Enclosure frame. The interior of the frame is punched with attachment points on 1" (25 mm) increments. Traditional thread-forming screws allow direct attachment to the frame. Drop-in bolts and nuts speed installation and still provide a bonded connection.

Part Number	Description	Shipping Weight lb (kg)
37940-001	M5.5 x 9 Torx Panhead Thread-Forming Screw	2 (0.9)
37941-001	M8 x 14 Drop-in Hammer Head Bolt & M8 Flange Nut	3 (1.4)
37942-001	M6 Drop-in Nut & M6 Hex Head Flange Screw	3 (1.4)

Ships in packs of 20.



37940 Shown



37941 Shown



37942 Shown

Vertical Rack Busbar

Vertical Rack Busbar provides a common bonding point for rack-mount equipment. Busbar is 5/8" x 1/4" (15.88 mm x 6.4 mm) hard-drawn electrolytic tough pitch 110 alloy copper with attachment points for ground lugs. Attachment points are tapped 1/4-20, and accept two-hole lugs with 1/4" holes on 5/8 in centers. Order RMR Modular Enclosure Vertical Busbar Mounting Kit separately.



Part Number	Length in (mm)	Attachment Points	Shipping Weight lb (kg)
40160-036	36 (910)	8	4 (1.8)
40160-072	72 (1830)	13	5 (2.3)
Vertical Busbar Mounting Kit (for frame and rail mount)			
37943-001		2 (1.0)	



Additional Support Accessories

Front-to-Rear Horizontal Support Slides for RMR Modular Enclosure

Use with equipment rails. Includes six slides.

Baying Kits for RMR Enclosure Systems

Baying Kits attach, or bay, two RMR Modular Enclosures together side-by-side.

- Brackets maintain the space between enclosures to ensure a tight seal
- Enclosures must be the same height and depth
- Side panels are removed or omitted from the both enclosures before the enclosures are bayed

RMR Modular Enclosure Baying Accessory Kit

Includes eight external baying brackets, two flat brackets and microcellular urethane foam seal to fill gap between enclosures.

RMR Modular Enclosure Internal Baying Accessory Kit With Seal

Includes four corner baying brackets, four flat brackets and microcellular urethane foam seal to fill gap between enclosures.

RMR Modular Enclosure Eyebolt Baying Kit

Includes two eyebolt baying brackets and installation hardware. Use with a Baying Accessory Kit.

Document Holder

Document Holder attaches to the enclosure with double backed adhesive tape.

Part Number	Description	Shipping Weight lb (kg)
37770-X03	Support Slides for 23.6"D (600 mm) Cabinet	26 (11.8)
37770-X05	Support Slides for 31.5"D (800 mm) Cabinet	34 (15.5)
37770-X07	Support Slides for 39.4" (1000 mm) Cabinet	41 (18.6)
37770-X09	Support Slides for 47.2"D (1200 mm) Cabinet	49 (22.3)
37820-X01	Baying Accessory Kit	5 (2.3)
37825-X01	Internal Baying Accessory Kit with Seal	6 (2.8)
37823-001	Eyebolt Baying Kit	7 (3.2)
37739-X01	Document Holder, A4	4 (1.9)
37739-X02	Document Holder, A3	5 (2.3)

X=color: C=Black, G=Hammer Gray.



Cabinet Includes:

- Enclosure with a hinged swing door
- Equipment mounting rails and/or mounting panels/personalized support options
- Metric hardware

RMR Swing Wall-Mount Enclosure

RMR Swing Wall-Mount Enclosure is a completely sealed, solid enclosure that features many modification possibilities. Many ventilation and cooling options are available to meet airflow requirements, and multiple cable entry points and accessories are available for configuration with short lead time.

RMR Swing Wall-Mount Enclosure features a three-part design with a solid rear section, hinged center section and a solid or windowed front door, equipped with a CH751 key-latch for security purposes. The enclosure's center section enables the front portion to release, swinging away from the wall section to provide front and rear access to equipment. This allows for quick installation and maintenance, which limits the amount of time that sensitive equipment is exposed to the environment. As a security measure to prevent unauthorized access, the center section of the RMR Swing Wall-Mount Enclosure is only accessible when the front door is unlatched.

- Provides equipment with NEMA Type 12 and IP 55 rated protection against ingress of solid foreign objects and dripping noncorrosive liquids, using advanced formed-in-place foam gasket technology at each panel and cable entry point
- Enables quick access to the front and rear of equipment through a double-hinged, swing-out design
- Supports airflow and cooling options specially certified for industrial applications to maintain equipment cooling requirements outside of normal IT settings and equipment rooms
- Features attachment points along the front, rear, top, bottom and sides, providing quick and secure mounting of plates, rails and accessories at any point along the frame
- Allows a complete enclosure solution to be configured under a single part number, including the exact size frame, mounting system, doors, gland plates and ventilation that you require
- Offers short lead times for modified enclosures—change size or color, and add openings for connections, controls and HMI

Cabinet Specifications:

- Heights:
 - 9U, 19.1" (486 mm)
 - 12U, 24.4" (619 mm)
 - 15U, 29.7" (753 mm)
 - 18U, 34.9" (886 mm)
 - 21U, 40.1" (1019 mm)
 - 26U, 48.9" (1241 mm)
- Widths: 23.6" (600 mm) and 27.6" (700 mm)
- Depths: 20.0" (510 mm), 24.0" (610 mm) and 29.9" (760 mm)
- Equipment Space: 19" EIA (482.6 mm) Equipment Mounting Rails: (1 pair) or (1) Fixed Depth Mounting Plate

Certifications:

- NEMA Type 12 and IEC 60529, IP 55

All Enclosures are:

- UL Listed, Industrial Control Panel Enclosures, Type 12, File Number NITW.E473128
- UL Listed, Industrial Control Panel
- UL Listed, Industrial Control Panel Enclosures for Canada, Type 12, File NITW7.E473128

Enclosures without filter fans or air conditioners are:

- UL Classified, Degrees of Protection by Enclosures Certified to IEC Publication, EOF1.E486325
- EIA-310 (for 19" EIA equipment rails)- Equipment mounting rails and/or mounting panels/personalized support options
- Metric hardware

RMR® SWING WALL-MOUNT ENCLOSURE

Use the part number matrix below to configure a RMR Swing Wall-Mount Enclosure. Choose the **Height**, **Width**, **Depth**, **FR**ame Style, **Front Door**, **Rear Door**, **Side Panel**, **Latch**, **Color**, **Bottom Panel** and **Top Panel**. **Example Cabinet Part Number: A3-11AA-1121-G11.3**

A 3 - H W D FR - FD RD SP L - C BP TP

1. Type

Double-Hinged	3
---------------	----------

2. Height

U	in	mm	
9	19.1	486	1
12	24.4	619	2
15	29.7	753	3
18	34.9	886	4
21	40.1	1019	5
26	48.9	1241	6

3. Width

in	mm	
23.6	600	1
27.6	700	2

4. Depth

in	mm	
20.0	510	A
24.0	610	B
29.9	760	C

5. Frame Style

Multi-Mount (Square-Punched) Rails, 1 Pair, 19" EIA (482.6 mm)	A
Fixed Depth Mounting Plate	B
Multi-Mount (Square-Punched) Rails, 1 Pair, 19" EIA and Fixed Depth Mounting Plate	C

6. Front Door

Single Solid Metal Door	1
Single Tempered Glass Door	2

12. Top Panel

1	Solid
2	Gland Panel
3	Brush Gland

11. Bottom Panel

1	Solid Bottom
2	Gland Plate
3	Brush Gland

10. Color

C	Black
G	Hammer Gray RAL 7035

9. Latch

2	Quarter-Turn Wing Knob with CH751 Keyed Lock
----------	--

8. Side Panels

1	Single Solid
2	Intake Filter Fan, 4.9" (125 mm), 38 CFM (65 CMH), 115 VAC
4	Cooling Unit, 900-1300 Btu/hr (263-381 W), 115 VAC

7. Rear Door

1	Not Applicable
----------	----------------



Cabinet is comprised of

- Front Door
- Center Section
- Rear Section

Equipment mounting options include:

- Fixed Depth Mounting Plate for Rear Section
- Adjustable Depth Mounting Plate for Center Section
- Multi-Mount (Square-Punched) mounting rails for Center Section



Cabinet Includes:

- Enclosure with a hinged swing door
- Equipment mounting rails and/or mounting panels/
personalized support options
- Metric hardware

RMR Fixed Wall-Mount Enclosure

RMR Fixed Wall-Mount Enclosure provides exceptional protection for network, communication, automation and control equipment in nonhazardous indoor locations. The RMR Fixed Wall-Mount Enclosure features welded steel panels with robotically applied, formed-in-place foam gaskets and sealed cable entry points.

These features effectively maintain the enclosure's NEMA 12 and IP 55 protection ratings, which certify the equipment is protected from the intrusion of solid foreign objects such as dirt, dust, lint and fibers, as well as noncorrosive liquid such from dripping and light spray or splashing. The RMR Fixed Wall-Mount Enclosure features a solid or windowed front door equipped with a CH751 key-latch for security purposes. The robust design of the RMR Fixed Wall-Mount Enclosure also protects personnel from hazardous moving parts and electrical equipment within the enclosure.

- Provides equipment with NEMA Type 12 and IP 55 rated protection against ingress of solid foreign objects and dripping noncorrosive liquids, using advanced formed-in-place foam gasket technology at each panel and cable entry point
- Offers airflow and cooling options specially certified for industrial applications to maintain equipment cooling requirements outside of normal IT settings and equipment rooms
- Features attachment points along the front, rear, top, bottom and sides, providing quick and secure mounting of plates, rails and accessories at any point along the frame
- Allows a complete enclosure solution to be configured under a single part number, including the exact size frame, mounting system, doors, gland plates and ventilation that you require

Cabinet Specifications:

Enclosure is rated for indoor use and protects equipment against the ingress of dust, lint and other debris, as well as dripping and splashing from noncorrosive liquids.

- Heights:
 - 9U, 19.1" (486 mm)
 - 12U, 24.4" (619 mm)
 - 15U, 29.7" (753 mm)
 - 18U, 34.9" (886 mm)
 - 21U, 40.1" (1019 mm)
 - 26U, 48.9" (1241 mm)
- Widths: 23.6" (600 mm) and 27.6" (700 mm)
- Depths: 20.0" (510 mm), 24.0" (610 mm) and 29.9" (760 mm)
- Equipment Space: 19" EIA (482.6 mm) Equipment Mounting Rails: (1 pair) or (1) Fixed Depth Mounting Plate

Certifications:

- NEMA Type 12 and IEC 60529, IP 55

All Enclosures are:

- UL Listed, Industrial Control Panel Enclosures, Type 12, File Number NITW.E473128
- UL Listed, Industrial Control Panel
- UL Listed, Industrial Control Panel Enclosures for Canada, Type 12, File NITW7.E473128

Enclosures without filter fans or air conditioners are:

- UL Classified, Degrees of Protection by Enclosures Certified to IEC Publication, EOFI-E486325
- EIA-310 (for 19" EIA equipment rails)- Enclosure with a hinged swing door
- Equipment mounting rails and/or mounting panels/personalized support options
- Metric hardware

RMR® FIXED WALL-MOUNT ENCLOSURE

Use the part number matrix below to configure a RMR Fixed Wall-Mount Enclosure. Choose the **Height**, **Width**, **Depth**, **FR**ame Style, **Front Door**, **Rear Door**, **Side Panel**, **Latch**, **Color**, **Bottom Panel** and **Top Panel**. **Example Cabinet Part Number: A2-11AA-1121-G113**

A	2	-	H	W	D	FR	-	FD	RD	SP	L	-	C	BP	TP
1. Type															
Single Door		2													
2. Height															
U	in	mm													
9	19.1	486	1												
12	24.4	619	2												
15	29.7	753	3												
18	34.9	886	4												
21	40.1	1019	5												
26	48.9	1241	6												
3. Width															
in	mm														
23.6	600	1													
27.6	700	2													
4. Depth															
in	mm														
20.0	510	A													
24.0	610	B													
29.9	760	C													
5. Frame Style															
Multi-Mount (Square-Punched) Rails, 1 Pair, 19" EIA (482.6 mm)															A
Fixed Depth Mounting Plate															B
6. Front Door															
Single Solid Metal Door															1
Single Tempered Glass Door															2
7. Rear Door															
1 Not Applicable															
8. Side Panels															
1 Single Solid															
2 Intake Filter Fan, 4.9" (125 mm), 38 CFM (65 CMH), 115 VAC															
4 Cooling Unit, 900-1300 Btu/hr (263-381 W), 115 VAC															
9. Latch															
2 Quarter-Turn Wing Knob with CH751 Keyed Lock															
10. Color															
C Black															
G Hammer Gray RAL 7035															
11. Bottom Panel															
1 Solid Bottom															
2 Gland Plate															
3 Brush Gland															
12. Top Panel															
1 Solid															
2 Gland Plate															
3 Brush Gland															



Equipment Mounting Rails

Equipment Mounting Rails provide support for 19" EIA (482.6 mm) rack-mount equipment and can be ordered with the enclosure

- Attach to the frame of the enclosure
- Adjustable-depth, supports 19" EIA (482.6 mm) rack-mount equipment
- Recommended to support cantilevered loads to eliminate equipment sag
- Universal (vertical) hole pattern, 1U are 1.75"H (44.45 mm)
- 12-24 tapped for screws or multi-mount (square-punched) for Clik-Nuts or cage nuts
- Electrically bonded to the enclosure frame



37065 Shown



37067 Shown

Multi-Mount (Square Punched) Rails for RMR Modular Enclosure				
Part Number Width - in (mm)		Enclosure Height in (mm)	Rack-Mount Space (U)	Shipping Weight lb (kg)
23.6 (600)	27.6 (700)			
37065-X01	37065-X31	19.1 (486)	9	6 (2.8)
37065-X04	37065-X34	24.4 (619)	12	7 (3.2)
37065-X07	37065-X37	29.7 (753)	15	8 (3.7)
37065-X10	37065-X40	34.9 (886)	18	8 (3.7)
37065-X13	37065-X43	40.1 (1019)	21	9 (4.1)
37065-X18	37065-X48	48.9 (1241)	26	10 (4.6)

X= Color; C= Black and G= Hammer Gray. Shipping weight is for 27.6"W (700 mm) models.

(12-24 Tapped) Rails for RMR Modular Enclosure				
Part Number Width - in (mm)		Enclosure Height in (mm)	Rack-Mount Space (U)	Shipping Weight lb (kg)
23.6 (600)	27.6 (700)			
37067-001	37067-031	19.1 (486)	9	6 (2.8)
37067-004	37067-034	24.4 (619)	12	7 (3.2)
37067-007	37067-037	29.7 (753)	15	8 (3.7)
37067-010	37067-040	34.9 (886)	18	8 (3.7)
37067-013	37067-043	40.1 (1019)	21	9 (4.1)
37067-018	37067-048	48.9 (1241)	26	10 (4.6)

Finish is Clear Brushed-Aluminum. Shipping weight is for 27.6"W (700 mm) models.

RMR Quick Wall-Mounting Kit

RMR Quick Wall-Mounting Kit features a cleat design that allows for quick and easy mounting of the RMR Wall-Mount Enclosure.

Part Number	Description Width - in (mm)	Shipping Weight lb (kg)
37045-X01	24 (610)	12 (5.5)
37045-X05	28 (712)	13 (5.9)

X= Color; C= Black and G= Hammer Gray.



Mounting Plates for RMR Wall-Mount Enclosures

Mounting Plates are flat panels that provide a way of attaching a variety of network automation or control equipment devices into the enclosure for flexible support configurations.

- Fixed Mounting Plates are solid metal panels that are installed in a side-to-side orientation at the rear of the enclosure onto the back of the frame and can be ordered with the enclosure
- Adjustable Mounting Plates are solid metal panels that attach in a side-to-side orientation in the middle section of the enclosure and can be adjusted in depth by one inch increments and are ordered as accessories

RMR Wall-Mount Enclosure Fixed Depth Mounting Plate					
Part Number Width - in (mm)		Enclosure Height in (mm)	Plate Height in (mm)	Plate Width in (mm)	Shipping Weight lb (kg)
23.6 (600)	27.6 (700)				
37075-X01	37075-X31	19.1 (486)	14 (356)	*	15 (6.9)
37075-X04	37075-X34	24.4 (619)	20 (508)	*	19 (8.7)
37075-X05	37075-X35	26.1 (664)	21 (534)	*	20 (9.1)
37075-X07	37075-X37	29.7 (753)	25 (635)	*	22 (10.0)
37075-X10	37075-X40	34.9 (886)	30 (762)	*	26 (11.8)
37075-X13	37075-X43	40.1 (1019)	35 (889)	*	30 (13.7)
37075-X18	37075-X48	48.9 (1241)	44 (1118)	*	36 (16.4)

X=Color; C=Black, G=Hammer Gray

Plate width is 20"W (508 mm) for 23.6"W (600 mm) enclosures and 24"W (610 mm) for 27.6"W (700 mm) enclosures. *Shipping weights are for 27.6"W (700 mm) models.

RMR Wall-Mount Enclosure Adjustable Depth Mounting Plate					
Part Number Width - in (mm)		Enclosure Height in (mm)	Plate Height in (mm)	Plate Width in (mm)	Shipping Weight lb (kg)
23.6 (600)	27.6 (700)				
37076-X01	37076-X31	19.1 (486)	14 (356)	*	15 (6.9)
37076-X04	37076-X34	24.4 (619)	20 (508)	*	19 (8.7)
37076-X07	37076-X37	29.7 (753)	25 (635)	*	22 (10.0)
37076-X10	37076-X40	34.9 (886)	30 (762)	*	26 (11.8)
37076-X13	37076-X43	40.1 (1019)	35 (889)	*	30 (13.7)
37076-X18	37076-X48	48.9 (1241)	44 (1118)	*	36 (16.4)

X=Color; C=Black, G=Hammer Gray

*Plate width is 20"W (508 mm) for 23.6"W (600 mm) enclosures and 24"W (610 mm) for 27.6"W (700 mm) enclosures. *Shipping weights are for 27.6"W (700 mm) models.

Lag Bolt Mounting Kit

Lag Bolt Mounting Kit includes (6) M8 x 40 mm Lag Bolts and Sealing Washers for attaching the enclosure to a plywood back board.

Part Number	Shipping Weight - lb (kg)
37049-001	3 (1.4)





Vertical Lashing Bracket

Vertical Cable Lashing Bracket creates a simple, separate vertical pathway for a small cable bundles and has multiple slots for straps or tie wraps to secure cables to the bracket.

- May be installed in front of or behind the equipment mounting rails or on either side of the cabinet frame
- An array of slots compatible with zip-ties
- Bracket is 1.6"W (41 mm)
- Includes: Brackets, installation hardware; order cable ties separately
- Material: Steel
- Electrically bonded to the enclosure frame

Part Number	Description Height in (mm)	Shipping Weight lb (kg)
37082-X01	19.1 (486)	4 (1.5)
37082-X04	24.4 (619)	5 (2.3)
37082-X07	29.7 (753)	5 (2.3)
37082-X10	34.9 (886)	5 (2.3)
37082-X13	40.1 (1019)	6 (2.8)
37082-X18	48.9 (1241)	6 (2.8)

X= Color; C= Black and G= Hammer Gray.



Short Finger Cable Manager

Short Finger Cable Manager is a T-shaped cable guide that creates a pathway for cables next to the rail for better organization. Use it with Front-to-Rear Lashing Bracket for optimum performance.

- Attaches to and adjusts with mounting rails
- Passes up to 24 cables per U space through openings
- Includes: Finger Cable Manager and installation hardware
- Material: Steel panels, plastic guides and latches

Part Number	Enclosure Height in (mm)	Rack-Mount Space (U)	Shipping Weight lb (kg)
37086-X01	19.1 (486)	9	5 (2.3)
37086-X04	24.4 (619)	12	5 (2.3)
37086-X07	29.7 (753)	15	5 (2.3)
37086-X10	34.9 (886)	18	6 (2.7)
37086-X13	40.1 (1019)	21	6 (2.7)
37086-X18	48.9 (1241)	26	7 (3.2)

X= Color; C= Black and G= Hammer Gray.



Front-To-Rear Cable Lashing Bracket

Front-to-Rear Cable Lashing Bracket routes high volumes of cables from front-to-rear of the cabinet, preventing cabling from invading the U space below the cable run.

- Attaches to the frame to create a dedicated front to rear pathway
- Includes: Trough and installation hardware; Material: Steel bracket

Part Number	Description Depth - in (mm)	Shipping Weight lb (kg)
37084-X01	20.0 (510)	4 (1.5)
37084-X02	24.0 (610)	4 (1.5)
37084-X03	29.9 (760)	5 (2.3)

X= Color; C= Black and G= Hammer Gray.



Brush Cable Entry Grommet

When NEMA Type 12 and IP 55 protection ratings are not essential, Brush Cable Entry Grommet helps block dust and particles from entering through cable access holes, while providing easier access to cables. Place grommets at the bottom openings for optimum protection.

- Material: Metal backed strip brush, nylon bristles with EPDM layer, plastic brush holder

Part Number	Enclosure Width in (mm)	Opening Size Width in (mm)	Opening Size Depth in (mm)	Shipping Weight lb (kg)
37097-001	23.6 (600)	20.9 (532)	3.5 (89)	4 (1.9)
37097-005	27.6 (700)	24.9 (632)	3.5 (89)	4 (1.9)



RMR Wall-Mount Enclosure Grounding Lug Kit

Grounding Lug Kit includes a Two-Hole Compression Lug sized for a #6 AWG conductor with .375" (9.5 mm) holes spaced on 1" (25.4 mm) centers and mounting hardware. Attaches to the RMR Wall-Mount Enclosure frame to provide a bonding point for the enclosure.

Part Number	Description	Shipping Weight lb (kg)
37009-001	Ground Lug	2 (0.9)



RMR Wall-Mount Enclosure Busbar Kit

Busbar Kit includes a 19"L (482.6 mm), 3/4"H (19.1 mm), 3/16" thick (4.8 mm) hard-drawn electrolytic tough pitch 110 alloy copper bar with eight #6-32 tapped lug mounting holes on 1" (25.4 mm) centers, two insulators and mounting hardware. Attaches to the RMR Wall-Mount Enclosures on the back panel and provides a common bonding point for equipment within the enclosure.

Part Number	Description	Shipping Weight lb (kg)
37008-001	Busbar Kit	4 (1.9)



UL Type 12/IP 55
Type 4/IP 66 options available

RMR® Floor-Mount Enclosures provide NEMA Type 4 or 12 protection for large electronic components and controls that require sturdy mounting. Floor stands elevate the enclosure above the floor for added clearance and easier cable access.

RMR Floor-Mount Enclosure

RMR Floor-Mount Enclosures provide exceptional material ingress protection for panel-mount networking, automation, control and instrumentation equipment in indoor and outdoor locations.

RMR Floor-Mount Enclosures feature floor stands that provide additional clearance and easy access for cable access through the bottom of the enclosure. The floor stands are bolted onto the frame and can be easily removed for relocation of the enclosure.

Eight heavy-duty mounting studs on the rear of the enclosure accept a mounting plate. The high-strength, solid mounting plate (ordered separately), attaches to the enclosure and provides a large mounting surface for equipment.

UL Type 4/IP 66 enclosures feature a removable center beam to maintain sealing performance between doors. Remove the center beam to conveniently mount large equipment onto the mounting plate, or to install the mounting plate with preinstalled equipment onto the frame. UL Type 12/IP 55 enclosures feature overlapping solid double doors with three-point latch but do not include a center beam.

- CPI Product Designer tool quickly configures a complete kit
- Sealed with continuous foam gasket technology
- Kitting and preinstallation of accessories to simplify ordering
- Competitive lead times

Key Features:

- UL Type 1, 2, 3, 3R, 4, 5, 12; IP 55/66*
- For indoor and outdoor use
- Floor stands provide additional clearance and easy access to bottom of the enclosure
- Continuous foam gasket seal
- Solid double door
- Three lock styles: keyed, double bit and square
- Wide range of sizes available

Note: Field modifications, including the addition of accessories, may result in a different protection rating.

Configure to Order Online:



CPI Product Designer creates unique industrial enclosures quickly and easily by allowing you to select the size, features and accessories needed for a specific application. Access this tool at chatsworth.com/product-designer.

Specifications/Ordering Notes:

For simplified ordering and full range of sizes and configurations, go to the CPI Product Designer at chatsworth.com/product-designer.



UL Type 12/IP 55

RMR Floor-Mount Enclosure, Type 12, with Floor Stand and Solid Double Door

UL Type 12/IP 55 enclosure is for indoor use; protects against dirt, dripping and light splash of noncorrosive liquid.

- Designed for NEMA Type 12/IP 55 applications. Also meets NEMA Type 1 and 5; and NEMA Type 2 with drain hole and NEMA Type 3R with drain hole and drip shield (hole must be between 1/8" to 1/4" (3 mm - 6 mm))
- Overlapping solid double door with 3-point latch mechanism provides easy access for control plate installation
- Latch style: 3-point mechanism with heavy-duty padlock swinghandle
- 3 lock styles: keyed CH751, double bit and square
- 3 lock styles: keyed CH751, double bit and square
- Min and max height: 54"H - 72"H (1372 mm - 1829 mm)
- Min and max widths: 42"W - 72"W (1067 mm - 1829 mm)
- Min and max depths: 8"D - 24"D (203 mm - 610 mm)
- Removable floor stands
- Available in welded mild steel with powder coat paint finish (color): Gray ANSI 61, Hammer Gray RAL7035.

Series A04, mild steel family of enclosures

Sample part number: A04-HHWWDD-X00



UL Type 4/IP 66

RMR Floor-Mount Enclosure, Type 4, with Floor Stand and Solid Double Door

UL Type 4/IP 66 enclosure is for outdoor use, protects against dirt, rain, sleet, snow, splash and hose down with noncorrosive liquid. Removable center beam provides convenient installation of mounting plate.

- Designed for NEMA Type 4/IP 66 applications. Also meets NEMA Type 1, 3, 5 and 12; and NEMA Type 2 and 3R with drain hole (hole must be between 1/8" to 1/4" (3 mm - 6 mm))
- Removable center beam
- 3 lock styles: keyed CH751, double bit and square
- Latch styles: 3-point mechanism with heavy-duty padlock swinghandle. Auxiliary ¼-turn latches are added on top and bottom of enclosures that are 31"W (787 mm) or wider
- Min and max height: 60"H - 74"H (1524 mm - 1880 mm)
- Min and max widths: 48"W - 72"W (1219 mm - 1829 mm)
- Min and max depths: 10"D - 24"D (254 mm - 610 mm)
- Removable floor stands
- Available in welded mild steel with outdoor-rated, powder coat paint finish (color): Gray ANSI 61, Hammer Gray RAL7035.

Series 05, mild steel, family of enclosures

Sample part number: A05-HHWWDD-X00

Configure to Order Online:



CPI Product Designer creates unique industrial enclosures quickly and easily by allowing you to select the size, features and accessories needed for a specific application. Access this tool at chatsworth.com/product-designer.



UL Type 12/IP 55



UL Type 4/IP 66

RMR® Free-Standing Enclosures provide NEMA Type 4 or 12 protection for large electronic components and controls that require sturdy mounting.

RMR Free-Standing Enclosure

RMR Free-Standing Enclosures by Chatsworth Products (CPI) provide exceptional material ingress protection for panel-mount networking, automation, control and instrumentation equipment in indoor and outdoor locations. Stainless steel option is available for applications that require a higher level of corrosion resistance.

Enclosures have mounting channels along the sides, top and bottom for attaching mounting plates (ordered separately) or other accessories. The mounting plate can be placed anywhere along the enclosure's mounting channels. Dual-access configuration is available for equipment access from either the front or rear of the enclosure and for back-to-back plate mounting.

The enclosure can be configured with single or dual access, solid single or double doors with a three-point latch mechanism. NEMA Type 4 enclosures with double doors feature removable center beam to maintain sealing performance between doors.

NEMA Type 12 enclosures feature overlapping solid double doors with three-point latch, but do not include a center beam.

- CPI Product Designer tool quickly configures a complete kit
- Sealed with continuous foam gasket technology
- Kitting and preinstallation of accessories to simplify ordering
- Competitive lead times

Key Features:

- UL Type 1, 2, 3, 3R, 4, 5, 12; IP 55/66*
- For indoor and outdoor use
- Easy-to-use side channels for mounting
- Continuous foam gasket seal
- Wide range of sizes available
- Single- and double-door options
- 3-point latch with choice of lock
- Optional adjustable-depth mounting plate

Note: Field modifications, including the addition of accessories, may result in a different protection rating.

Configure to Order Online:



CPI Product Designer creates unique industrial enclosures quickly and easily by allowing you to select the size, features and accessories needed for a specific application. Access this tool at chatsworth.com/product-designer.

Specifications/Ordering Notes:

For simplified ordering and full range of sizes and configurations, go to the CPI Product Designer at chatsworth.com/product-designer.



UL Type 12/IP 55

RMR Free-Standing Enclosure, Type 12, with Solid Double Door

UL Type 12/IP 55 enclosure is for indoor use and protects against dirt, dripping and light splash of noncorrosive liquid.

- Designed for NEMA Type 12/IP 55 applications. Also meets NEMA Type 1 and 5; and NEMA Type 2 with drain hole and NEMA Type 3R with drain hole and drip shield (hole must be between 1/8" to 1/4" (3 mm - 6 mm))
- Overlapping solid double door with 3-point latch mechanism provides easy access for control preinstallation
- Latch style: 3-point mechanism with heavy-duty padlock swinghandle
- 3 lock styles: keyed CH751, double bit and square
- Min and max height: 60"H - 90"H (1524 mm - 2286 mm)
- Min and max widths: 48"W - 72"W (1219 mm - 1829 mm)
- Min and max depths: 18"D - 36"D (457 - 914)
- Available in welded mild steel with powder coat paint finish (color): Gray ANSI 61, Hammer Gray RAL7035.
- 4 eye bolts are included with enclosures that are over 24"D (610 mm)
- Order mounting plate(s) separately; use CPI Product Designer for quick and easy selection.

Series A06, mild steel, family of enclosures

Sample part number: A06-HHWWDD-X00



UL Type 12/IP 55

RMR Free-Standing Enclosure, Type 12, Dual Access with Solid Double Door

UL Type 12/IP 55 enclosure is for indoor use and protects against dirt, dripping and light splash of noncorrosive liquid.

- Designed for NEMA Type 12/IP 55 applications. Also meets NEMA Type 1 and 5; NEMA Type 2 with drain hole and NEMA Type 3R with drain hole and drip shield (hole must be between 1/8" to 1/4" (3 mm - 6 mm))
- Dual access provides additional mounting plate placement and access to either front or rear of the enclosure
- Overlapping solid double door with 3-point latch mechanism provides easy access for control plate installation
- Latch style: 3-point mechanism with heavy-duty padlock swinghandle
- 3 lock styles: keyed CH751, double bit and square
- Min and max height: 72"H - 90"H (1829 mm - 2286 mm)
- Min and max widths: 48"W - 72"W (1219 mm - 1829 mm)
- Min and max depths: 24"D - 36"D (610 mm - 914 mm)
- Available in welded, mild-steel with powder coat paint finish (color): Gray ANSI 61, Hammer Gray RAL7035.
- 4 eye bolts are included with enclosures that are over 24"D (610 mm)
- Order mounting plate(s) separately; use CPI Product Designer for quick and easy selection.

Series A07, mild steel, family of enclosures

Sample Part number: A07-HHWWDD-X00

Specifications/Ordering Notes:

For simplified ordering and full range of sizes and configurations, go to the CPI Product Designer at chatsworth.com/product-designer.



LISTED



UL Type 4/IP 66

RMR Free-Standing Enclosure, Type 4, with Solid Double Door

UL Type 4/IP 66 enclosure is for outdoor use and protects against dirt, rain, sleet, snow, splash and hose down with noncorrosive liquid.

- Designed to meet NEMA Type 4/IP 66 applications. Also meets NEMA Type 1, 3, 5, and 12; and NEMA Type 2 and 3R with drain hole (hole must be between 1/8" to 1/4" (3 mm - 6 mm))
- Solid double doors and center beam. Removable center beam provides convenient installation of mounting plate
- 3 lock styles: keyed CH751, double bit and square
- Latch style: 3-point mechanism with heavy-duty padlock swinghandle.
Auxiliary ¼-turn latches are added on top and bottom of enclosures that are 31"W (787 mm) or wider
- Min and max height: 60"H - 90"H (1524 mm - 2286 mm)
- Min and max widths: 48"W - 72"W (1219 mm - 1829 mm)
- Min and max depths: 18"D - 36"D (457 mm - 914 mm)
- Available in welded mild steel with outdoor-rated, powder coat paint finish (color): Gray ANSI 61, Hammer Gray RAL7035.
- 4 eye bolts are included with enclosures that are over 24"D (610 mm)
- Order mounting plate(s) separately; use CPI Product Designer for quick and easy selection

Series A08, mild steel, family of enclosures

Sample Part number: A08-HHWWDD-X00



LISTED



UL Type 4/IP66

RMR Free-Standing Enclosure, Type 4 and 12, with Solid Single Door

UL Type 4/IP66 and 12/IP 55 enclosures are for either indoor or outdoor use and protect against dirt, rain, sleet, snow, splash and hose down with noncorrosive liquids.

- Designed for NEMA Type 4/IP 66 and 12/IP 55 applications. Also meets NEMA Type 1 and 5 ; and NEMA Type 2 and 3R with drain hole (hole must be between 1/8" to 1/4" (3 mm - 6 mm))
- 3 lock styles: keyed CH751, double bit and square
- Latch styles: 3-point mechanism with heavy-duty padlock swinghandle.
Auxiliary ¼-turn latches are added on top and bottom of enclosures that are 31"W (787 mm) or wider
- Min and max height: 60"H - 90"H (1524 mm - 2286 mm)
- Min and max widths: 24"W - 36"W (610 mm - 914 mm)
- Min and max depths: 18"D - 36"D (457 mm - 914 mm)
- Available in welded mild steel with outdoor-rated, powder coat paint finish (color): Gray ANSI 61, Hammer Gray RAL7035.
- 4 eye bolts are included with enclosures that are over 24"D (610 mm)

Series A09, mild steel, family of enclosures

Sample Part number: A09-HHWWDD-X00

Configure to Order Online:



CPI Product Designer creates unique industrial enclosures quickly and easily by allowing you to select the size, features and accessories needed for a specific application. Access this tool at chatsworth.com/product-designer.

Specifications/Ordering Notes:

For simplified ordering and full range of sizes and configurations, go to the CPI Product Designer at chatsworth.com/product-designer.



UL Type 4/IP 66

RMR Free-Standing Enclosure, Type 4 and 12, Dual Access with Solid Single Door

UL Type 4/IP 66 and 12/IP 55 enclosures are for either indoor or outdoor use and protect against dirt, rain, sleet, snow, splash and hose down with noncorrosive liquids.

- Designed for NEMA Type 4/IP 66 and 12/IP 55 applications. Also meets NEMA Type 1, 3 and 5; and NEMA Type 2 and 3R with drain hole (hole must be between 1/8" to 1/4" (3 mm - 6 mm))
- Dual access provides additional mounting plate placement and access to either side of the enclosure
- 3 lock styles: keyed CH751, double bit and square
- Latch styles: 3-point mechanism with heavy-duty padlock swinghandle. Auxiliary ¼-turn latches are added on top and bottom of enclosures that are 30" (762 mm) wide or wider
- Min and max height: 72"H – 90"H (1829 mm - 2286 mm)
- Min and max widths: 24"W – 36"W (610 mm - 914 mm)
- Min and max depths: 24"W – 36"W (610 mm - 914 mm)
- Available in welded mild steel with outdoor-rated, powder coat paint finish (color): Gray ANSI 61, Hammer Gray RAL7035.
- 4 eye bolts are included with enclosures that are over 24"D (610 mm)

Series A10, mild steel, family of enclosures

Sample Part number: A10-HHWWDD-X00

Configure to Order Online:



CPI Product Designer creates unique industrial enclosures quickly and easily by allowing you to select the size, features and accessories needed for a specific application. Access this tool at chatsworth.com/product-designer.



UL Type 4/IP 66



UL Type 12/IP 55

RMR® Standard Wall-Mount Enclosures provide NEMA Type 4 or 12 protection for smaller electronic components and controls that require sturdy wall mounting.

RMR Standard Wall-Mount Enclosure

RMR Standard Wall-Mount Enclosures by Chatsworth Products (CPI) provide exceptional material ingress protection for panel-mount networking, automation, control and instrumentation equipment in indoor or outdoor locations.

Mount equipment into the enclosure with mounting plates (ordered separately). The removable mounting plates attach to the rear of the enclosure. Use the optional Swing-Out Kit for RMR Mounting Plate (ordered separately) to install the mounting plate at the front of the enclosure.

UL Type 4/IP 66 enclosures with double doors feature a removable center beam to maintain sealing performance between doors. UL Type 12/IP 55 enclosures feature overlapping solid double doors with three-point latch but do not include a center beam.

- CPI Product Designer tool quickly configures a complete kit
- Sealed with continuous foam gasket technology
- Kitting and preinstallation of accessories to simplify ordering
- Competitive lead times

Key Features:

- UL Type 1, 2, 3, 3R, 4, 5, 12; IP 55/66*

- For indoor and outdoor use
- Continuous foam gasket seal
- Integrated mounting holes or welded mounting brackets
- Wide range of sizes available
- Single- and double-door options
- 3-point or 1/4-turn latch with choice of lock
- Optional rear mounting plate

Note: Field modifications, including the addition of accessories, may result in a different protection rating.

Configure to Order Online:



CPI Product Designer creates unique industrial enclosures quickly and easily by allowing you to select the size, features and accessories needed for a specific application. Access this tool at chatsworth.com/product-designer.

Specifications/Ordering Notes:

For simplified ordering and full range of sizes and configurations, go to the CPI Product Designer at chatsworth.com/product-designer.



UL Type 4/IP 66

RMR Standard Wall-Mount Enclosure, Type 4 and 12 with Single Door

UL Type 4/IP 66 and 12/IP 55 enclosures are for either indoor or outdoor use and protect against dirt, rain, sleet, snow, splash and hose down with noncorrosive liquids.

- Designed for NEMA Type 4/IP 66 and 12/IP 55 applications. Also meets NEMA Type 1, 3, and 5; and NEMA Type 2 and 3R with drain hole (hole must be between 1/8" to 1/4" (3 mm - 6 mm))
- Solid or tempered glass single door options
- 2 latch styles: 3-point mechanism and ¼-turn latch. Auxiliary ¼-turn latches are added on top and bottom of enclosures with doors that are 31"W (787 mm) or wider
- 4 lock styles: keyed CH751, double bit and square on 3-point latches; double bit, square and slotted on ¼-turn latches
- 2 mounting methods: integrated mounting hole or welded mounting bracket
- Min and max height: 12"H – 72"H (305 mm - 1829 mm)
- Min and max widths: 10"W – 36"W (254 mm - 914 mm)
- Min and max depths: 6"D – 24"D (152 mm - 610 mm)
- Available in welded mild steel with outdoor-rated, powder coat paint finish (color): Gray ANSI 61, Hammer Gray RAL7035.

Series A11, mild steel, family of enclosures

Sample Part number: A11-HHWWDD-X00

Configure to Order Online:



CPI Product Designer creates unique industrial enclosures quickly and easily by allowing you to select the size, features and accessories needed for a specific application. Access this tool at chatsworth.com/product-designer.

Specifications/Ordering Notes:

For simplified ordering and full range of sizes and configurations, go to the CPI Product Designer at chatsworth.com/product-designer.

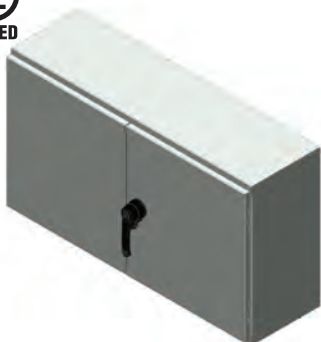

UL Type 12/IP 55

RMR Standard Wall-Mount Enclosure, Type 12 with Solid Double Door

UL Type 12/IP 55 enclosures are for indoor use and protect against dirt, rain, light splash and with noncorrosive liquids.

- Designed for NEMA Type 12/IP 55 applications. Also meets NEMA Type 1 and 5; NEMA Type 2 with drain hole and NEMA Type 3R with drain hole and drip shield (hole must be between 1/8" to 1/4" (3 mm - 6 mm))
- Solid, overlapping double door
- 2 mounting methods: integrated mounting hole or welded mounting bracket
- Latch styles: 3-point mechanism
- 3 lock styles: keyed CH751, double bit and square
- Min and max height: 24"H – 48"H (610 mm - 1219 mm)
- Min and max widths: 42"W – 60"W (1667 mm - 1524 mm)
- Min and max depths: 8"D – 16"D (203 mm - 406 mm)
- Available in welded mild steel with powder coat paint finish (color): Gray ANSI 61, Hammer Gray RAL7035.

Series A12, mild steel family of enclosures

Sample part number: A12-HHWWDD-X00



UL Type 4/IP 66

RMR Standard Wall-Mount Enclosure, Type 4 with Solid Double Door

UL Type 4/IP 66 enclosure is for outdoor use and protects against dirt, rain, sleet, snow, splash and hose down with noncorrosive liquid.

- Designed for UL Type 4/IP 66 applications. Also meets NEMA Type 1, 3, 5 and 12; and NEMA Type 2 and 3R with drain hole (hole must be between 1/8" to 1/4" (3 mm - 6 mm))
- Solid double doors and center beam. Removable center beam provides convenient installation of mounting plate
- 4 lock styles: keyed CH751, double bit, square and slotted
- 2 latch styles: 3-point and ¼-turn. Auxiliary ¼-turn latches are added on top and bottom of enclosures that are 31"W (787 mm) or wider
- 2 mounting methods: integrated mounting hole or welded mounting bracket
- Min and max height: 24"H – 48"H (610 mm - 1219 mm)
- Min and max widths: 42"W – 60"W (1667 mm - 1524 mm)
- Min and max depths: 8"D – 16"D (203 mm - 406 mm)
- Available in welded mild steel with outdoor-rated, powder coat paint finish (color): Gray ANSI 61, Hammer Gray RAL7035.

Series A13, mild steel, family of enclosures

Sample Part number: A13-HHWWDD-X00

Configure to Order Online:



CPI Product Designer creates unique industrial enclosures quickly and easily by allowing you to select the size, features and accessories needed for a specific application. Access this tool at chatsworth.com/product-designer.



Swing-Out Plate Mounting Kit



Bracket Kit for RMR Standard Wall-Mount Enclosure



Grounding and Bonding Kit



Drip Shield Assembly

Swing-Out Plate Mounting Kit

The Swing-Out Plate Mounting Kit installs at the front of the enclosures and converts a standard mounting plate into a swing-out mounting plate (ordered separately). The Kit includes brackets, hinges and mounting hardware that attach to the front of the enclosure to allow easy access to electronic components.

Mounting Bracket Kit for RMR Standard Wall-Mount Enclosure

The Mounting Bracket Kit mounts RMR Standard Wall-Mount Cabinets to the wall. - Required for NEMA Type 4 and IP 66 applications. Includes 4 brackets and screws.

RMR Enclosure Grounding and Bonding Kit

The RMR Enclosure Grounding and Bonding Kit provides bonding to the enclosure or bonds the optional mounting plate. Includes a 12" (305 mm), 6-gauge with dual M8 ring terminals and hardware. Compatible with RMR Floor-Mount, RMR Free-Standing and RMR Standard Wall-Mount Enclosures.

RMR Enclosure Drip Shield Assembly

Required to meet NEMA Type 3R when using a NEMA Type 12/IP 55 enclosure. It is used to provide additional protection against ice and rain.

Refer to enclosure ordering tables for sampling of Drip Shield Assembly part numbers. Go to the CPI Product Designer chatsworth.com/product-designer to configure an RMR Enclosure with Drip Shield Assembly.

Part Number	Description	Shipping Weight lb (kg)
DF0021-000000-X01	Swing-Out Plate Mounting Kit 37" - 62" (940 mm - 1575 mm)	4 (1.8)
DF0032-000000-X01	Swing-Out Plate Mounting Kit 37" - 62" (940 mm - 1575 mm)	5.5 (2.5)
DF0033-000000-X01	Swing-Out Plate Mounting Kit 37" - 62" (940 mm - 1575 mm)	3 (1.4)
DF0024-000000-X01	Mounting Bracket Kit for RMR Standard Wall-Mount Enclosures	1 (0.5)
DF0023-000000-001	Grounding and Bonding Kit	0.5 (0.2)

Note: X=Color: (-G00) for Hammer Gray RAL 7035, (-H00) for Light Gray ANSI 61.

Configure to Order Online:



CPI Product Designer creates unique industrial enclosures quickly and easily by allowing you to select the size, features and accessories needed for a specific application. Access this tool at chatsworth.com/product-designer.



Solid Mounting Plate

Solid Mounting Plates

Solid Mounting Plates are installed at the rear of the enclosure frame. Network, automation and control equipment devices can be installed onto the mounting plate. Refer to enclosure ordering tables for sampling of mounting plate part numbers. Go to the CPI Product Designer at chatsworth.com/product-designer to configure.

RMR Enclosure Threaded Drain Plug Kit

The RMR Enclosure Threaded Drain Plug Kit prevents accumulation of condensed water by allowing it to drain out the bottom of the enclosure. The drain plugs also vent air out of the enclosures, helping to equalize air pressure. Install vent drains at the bottom of the enclosures. Includes vent drain and retaining nut. Compatible with all RMR Enclosures.



Threaded Drain Plug Kit

RMR Enclosure Door Stop Kit

The RMR Enclosure Door Stop Kit secures the door of the enclosure in the open position. It can be mounted on either left- or right-hinged doors. Includes mounting hardware. Kit includes door stop and mounting hardware. Compatible with RMR Floor-Mount, RMR Free-Standing and RMR Standard Wall-Mount Enclosures.

RMR Enclosure XL Polyvent Protective Vent Kit

RMR Enclosure XL Polyvent Protective Vent Kit provides ventilation and equalizes air pressure in the event of drastic temperature changes. Pressure equalization is essential to protect the enclosure seal from damage. Installation hardware included. Kit includes vent and retaining nut. Compatible with all RMR enclosures.



XL Polyvent Protective Vent Kit

LED Light Kit

The LED Light Kit provides additional lighting inside the enclosure. Two types available: On-off switch or motion sensor. Voltage: 100 - 240 V, 50/60 Hz; NEMA 1-15P power cord.



LED Light Kits

Part Number	Description	Shipping Weight lb (kg)
DF0025-000000-001	RMR Enclosure Threaded Drain Plug Kit	1 (0.5)
DF0022-000000-001	RMR Enclosure Door Stop Kit	1 (0.5)
DF0028-000000-001	RMR Enclosure XL Polyvent Protective Vent Kit	0.5 (0.2)
DF0030-000000-001	LED Light Kit, On-Off Switch	0.5 (0.2)
DF0031-000000-001	LED Light Kit, Motion Sensor	0.5 (0.2)

Configure to Order Online:



CPI Product Designer creates unique industrial enclosures quickly and easily by allowing you to select the size, features and accessories needed for a specific application. Access this tool at chatsworth.com/product-designer.



Thermal Management Accessories for RMR Enclosure Systems

CPI offers a comprehensive line of Filter Fans and cooling units that provide superior thermal management to help protect the life of the electronic equipment in environments that require NEMA Type 12 and IP 55 protection. Three cooling methods are available to address different applications and requirements:

- Forced Convection
- Natural Convection
- Closed-Loop Cooling

Forced Convection with Filter Fans

Use CPI Filter Fans to propel the cool, ambient air into the enclosure. The patented click mechanism on the Filter Fans has a unique, four-corner fastening system that enables safe and quick, tool-less installation, while maintaining the rated seal, and allowing the filter medium to be replaced in seconds.

For intake fans, once installed, a slight positive pressure builds up inside the cabinet, so that only air filtered by the Filter Fans flows into the enclosure. The air propelled into the cabinet displaces the warm air that exits through the exhaust filter.

The fluted filter mat's folded structure provides airflow and maintains the required NEMA Type 12 protection, while also extending the filter's lifetime 300 percent longer than conventional filters.

- Multiple sizes available
- Top-, side- or front-mounting
- Easy, tool-less installation
- Maintains NEMA Type 12 protection rating
- Hinged grill allows easy filter replacement
- Optimized airflow and reduced energy consumption
- High-quality fluted filter mat provides 300% longer service time

Specifications:

- Includes: Fan housing, fan, filter, installation hardware
- Installation: Snap fastener without screws
- Housing Material: Injection-molded thermoplastic, self-extinguishing, UL 94 V0; top fan also has a painted metal cover
- Power Connection: Terminal Strip Approvals; UL®, cUL, CE Marking
- Optional power cord sold separately



RMR Modular Enclosure Filter Fan

Part Number Type of Filter		Cutout Size in (mm)	Airflow CFM (CMH)	Voltage	Color	Shipping Weight lb (kg)
Intake	Exhaust					
37920-001	37920-002	7 (177)	65 (110)	115	Hammer Gray	2 (0.9)
37920-003	37920-004	7 (177)	65 (110)	230	Hammer Gray	2 (0.9)
37920-005	37920-006	7 (177)	65 (110)	115	Black	2 (0.9)
37920-007	37920-008	7 (177)	65 (110)	230	Black	2 (0.9)
37921-001	37921-002	11.5 (291)	560 (951)	115	Hammer Gray	2 (0.9)
37921-003	37921-004	11.5 (291)	560 (951)	230	Hammer Gray	2 (0.9)
37921-005	37921-006	11.5 (291)	560 (951)	115	Black	2 (0.9)
37921-007	37921-008	11.5 (291)	560 (951)	230	Black	2 (0.9)

Filter Fans

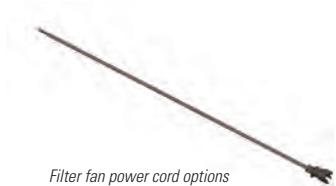

Filter fan power cord options

RMR Modular Enclosure Top Exhaust Fan					
Part Number	Cutout Size in (mm)	Airflow CFM (CMH)	Voltage	Color	Shipping Weight lb (kg)
37903-001	11.5 (291)	441 (749)	115	Hammer Gray	2 (0.9)

Note: Use Top Exhaust Filter Fan Kit with two Intake Filter Kits. All kits should be the same size. Optional power cord sold separately.

RMR Power Cord For Filter Fan			
Part Number	Voltage	Plug Type	Shipping Weight lb (kg)
37902-001	115	NEMA 5-15P	2 (0.9)
37902-002	230	NEMA 6-15P	2 (0.9)
37902-003	115 or 230	IEC C14	2 (0.9)

Color: Black. Order one Power Cord per Filter Fan Kit. Match to Fan Voltage requirement.

RMR Wall-Mount Enclosure Filter Fan						
Part Number Fan Configuration		Cutout Size in (mm)	Airflow CFM (CMH)	Voltage	Color	Shipping Weight lb (kg)
Intake	Exhaust					
37101-001	37101-002	6 (153)	38 (65)	115	Hammer Gray	5 (2.3)
37101-003	37101-004	6 (153)	38 (65)	230	Hammer Gray	5 (2.3)
37101-005	37101-006	6 (153)	38 (65)	115	Black	5 (2.3)
37101-007	37101-008	7 (177)	38 (65)	230	Black	5 (2.3)

Note: Use Filter Fan Kit with a Filter Kit. Both kits should be the same size. Optional power cord sold separately.

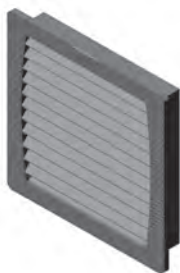

Filter Kits

Effective when the amount of heat being removed from the enclosure is minimal.

RMR Modular Enclosure Filter Kit		
Part Number	Filter Cutout in (mm)	Shipping Weight lb (kg)
37898-00X	7 (177)	2 (1)
37899-00X	11.5 (291)	3 (2)

X=Color, 1=Hammer Gray, 2- Black

RMR Replacement Filter Mats			
Part Number	Filter Cutout in (mm)	Filter Type	Shipping Weight lb (kg)
37116-001	4.9 (125)	150G/M2	2 (0.9)
37117-001	4.9 (125)	Fluted	3 (2.0)

RMR Wall-Mount Enclosure Filter Kit		
Part Number	Filter Cutout in (mm)	Shipping Weight lb (kg)
37102-00X	4.9 (125)	4 (1.9)

X=Color, 1=Hammer Gray, 2- Black



Note: P/N 39700-XXX is recommended for use with 37872-XXX or 37896-XXX door.

P/N 37901-XXX is recommended for use with 37879-XXX /side Panel.

Closed Loop Cooling

Closed-loop cooling is required when the ambient temperature is greater than the target internal temperature of the enclosure, or when higher ingress protection (NEMA Type 12 rating) is necessary. CPI offers closed-loop cooling units by Pfannenberg, which consist of two separate circulation systems. One system seals out the ambient air, cooling and recirculating clean, cool air throughout the enclosure. The second system uses ambient air to remove and discharge the heat.

Cooling units operate on the principle of the Carnot cycle. This means that the cooling unit functions as a heat pump that “pumps” the thermal energy transferred from the electronic enclosure (heat dissipated from the components) up to a higher level of temperature (the ambient temperature can reach levels as high as + 55 °C). At the same time, the air inside the enclosure is cooled down by the evaporator and dehumidified.

When using cooling units, ensure a good supply of air intake and outtake from the external circuit of the cooling unit, so that thermal energy can be transferred to the surroundings. The lowest temperature inside the enclosure may not necessarily be the best. CPI recommends an inside temperature of 95 °F (35 °C), which represents a good compromise between service life and the accumulation of condensation.

- Closed loop isolates the external ambient air from the internally conditioned air, at the same time, the rise of contaminants entering the enclosure
- Multiple sizes available
- Side- or front-mounting
- Performs efficiently in high-temperature areas
- Uses environmentally friendly HFC-free R134a refrigerant
- Backward curve impeller fan optimizes airflow and extends service life
- Wide condenser fin spacing reduces particulate clogging while balancing performance
- Hermetically sealed compressors prevent refrigerant loss
- Actively evaporates condensation
- Optional power cord sold separately.

RMR Modular Enclosure Indoor NEMA Type 12 Cooling Units–3000-4000 BTU/hr (879-1172 W) Capacity

Attaches to the outside of the AC Door Assembly.

- Cooling Unit is 30”H (750 mm) x 16”W (397 mm) x 10”D (239 mm).

Part Number	Voltage	Color	Shipping Weight lb (kg)
37900-001	115	Hammer Gray	100 (45.4)
37900-002	230	Hammer Gray	100 (45.4)
37900-003	115	Black	100 (45.4)
37900-004	230	Black	100 (45.4)

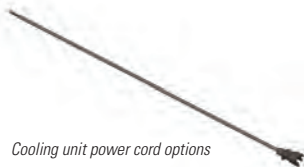

Cooling unit power cord options

Power Cord for Cooling Units			
Part Number	Voltage	Plug Type	Shipping Weight lb (kg)
37908-001	125	5-15P	2 (1.0)
37908-002	230	6-15P	2 (1.0)
37908-003	250	IEC C14	2 (1.0)

RMR Modular Enclosure Indoor NEMA Type 12 Cooling Units–3000-4000 BTU/hr (879-1172 W) Capacity

Attaches to the outside of the AC Door Assembly.

- Cooling Unit is 30”H (750 mm) x 16”W (397 mm) x 10”D (239 mm).

Part Number	Voltage	Color	Shipping Weight lb (kg)
37901-001	115	Hammer Gray	100 (45.4)
37901-002	230	Hammer Gray	100 (45.4)
37901-003	115	Black	100 (45.4)
37901-004	230	Black	100 (45.4)



37912 Shown

Roxtec Sealing Systems for RMR Enclosure Systems

Roxtec sealing solutions maintain the enclosure's NEMA Type 12 and IP 55 protection ratings around cable openings.

- Compact seals provide equipment protection against water, dust, insects and rodents
- 2-piece grommet assembly includes a frame and multidiameter modules that seal around cables
- Each grommet includes several modules to pass multiple cables of various diameters

Part Number	Roxtec Model Frame/Modules	Cutout Size	Depth in (mm)	# of Cables	Cable Diameter Range in (mm)	Shipping Weight lb (kg)
37912-001	ComSeal 10/10	2.2 (56)	5.8 (149)	20	.138 - .650 (3.5 - 16.5)	4 (1.9)
37913-001	ComSeal 15/3	2.4 (61)	7.6 (195)	3	1.102 - 1.693 (28 - 43)	4 (1.9)
37914-001	ComSeal 16/16	2.2 (56)	8.2 (209)	16	.138 - .650 (3.5 - 16.5)	4 (1.9)
37915-001	ComSeal 32/32	4.0 (103)	8.2 (209)	32	.138 - .650 (3.5 - 16.5)	5 (2.3)
RMR Gland Seal						
37916-001	RG M63/4	2.5 (63) Ø	.157 (4)	4	.138 - .650 (3.5 - 16.5)	4 (1.9)
37917-001	RG M63/9	2.5 (63) Ø	.157 (4)	4	.138 - .650 (3.5 - 16.5)	4 (1.9)

Note: On ComSeal, allow a 15 mm clearance around the cutout for securing the grommet to the enclosure. On RG M63, allow a 10 mm diameter space around the cutout for securing the grommet. The ComSeal frame is .59"H (15 mm). The RG M63 frame is 2 "H (51.5 mm). Refer to installation instructions for exact cutout dimensions. For other options, please contact CPI.

RMR EPDM Snap-In Liquid Tight Grommet

Snap-In Liquid Tight Grommet keeps liquids from leaking through cable openings

- Meets NEMA Type 12 and IP 55 protection ratings
- Accepts a single cable with diameter range 1.06"-1.38" (27-35 mm)
- Knock-out panel opening should be 1.98" (50 mm)
- Fits panel thickness range 0.05"-0.20" (1.3-5.1 mm)



Part Number	Shipping Weight - lb (kg)
37115-001	4 (1.9)

SECTION 7

WIRELESS ENCLOSURES

Wi-Tile™ Collection	7-3
In-Plane™ Collection	7-4
H-Plane™ Collection	7-5
Skybar™ Collection	7-6
Netpoint™ Collection	7-7



Learn about CPI's Standard Limited Warranty and Extended Limited Warranties. See page vii for details.

WIRELESS ENCLOSURES

Enclosures and mounting solutions for every Wi-Fi and Small Cell access point, in any location. In seconds, the Solutions Finder identifies solutions based on your AP and installation environment, and highly trained representatives can guide you through the selection and ordering process from start to finish.

Where Can I Learn More?

To learn more about Oberon™, a division of Chatsworth Products, Wireless Enclosures or to find additional part numbers not listed in this catalog, please visit the website, oberonwireless.com.

Related Tools:

- Solutions Finder

Featured Product:



A division of Chatsworth Products

Wi-Tile™ Collection

Enclosure mounts and secures Wi-Fi APs flush to the ceiling. This metal enclosure replaces a standard ceiling tile, and its larger back-box is suitable for larger APs and antennas. APs are mounted in the door, or inside the enclosure in models with the ABS or frosted polycarbonate plastic dome. The interchangeable door simplifies AP and antenna moves, adds, and changes.



Enclosure with Cisco 9130 Door

Wi-Tile™ Collection

Economical, locking, suspended ceiling Wi-Tile™ enclosure mounts and secures Wi-Fi APs flush to the ceiling. This metal enclosure replaces a standard ceiling tile, and its larger back-box is suitable for larger APs and antennas. APs are mounted in the door, or inside the enclosure in models with the ABS or frosted polycarbonate plastic dome. The interchangeable door simplifies AP and antenna moves, adds, and changes.

- Performance: UL listed for low voltage applications. Designed to meet NEC300-22 and 300-23 for plenum installations.
- Solid back-box fills opening behind AP, creating an effective fire, smoke and dust barrier to simplify Infection Control Risk Assessment (ICRA) compliance.
- De-rate AP operating temperature range by 10.8°F (6°C) when mounted in enclosure
- Enclosure must be supported by the building structure independent of the suspended ceiling
- Firestop grommet for insertion into back-box, large enough for 2 Cat6A cables
- 1 in. trade size knockouts in four walls
- Maximum weight inside enclosure is 25 lb (11.3 kg)
- Ceiling enclosure size: 3"H x 23.75"W x 23.75"L (76 mm x 603 mm x 603 mm)
- Back-box size: 3"H x 18.5" x 18.5" (76 mm x 470 mm x 470 mm)
- Weight: 16 lb (7.3 kg) typical
- Material: Steel
- Finish: White



For additional technical detail, visit: oberonwireless.com. Or contact Oberon at sales@oberonwireless.com or 1-877-867-2312.

Part Number	Description	Shipping Weight lb (kg)
1047-ARAP635	Enclosure with Aruba AP635 Door	20 (9)
1047-ARAP555	Enclosure with Aruba AP555 Door	20 (9)
1047-ARAP535	Enclosure with Aruba AP535 Door	20 (9)
1047-COAP9136	Enclosure with Cisco 9136 Series AP Door	20 (9)
1047-COAP9130	Enclosure with Cisco 9130 Series AP Door	20 (9)
1047-COAP9120	Enclosure with Cisco 9120 Series AP Door	20 (9)
1047-COAP9115	Enclosure with Cisco 9115 Series AP Door	20 (9)
1047-AP510i	Enclosure with Extreme AP510i Door	20 (9)

Note: Enclosures do not include access points. Enclosure doors are cut to fit specific access points. Other options available for other access points, tegular flange ceilings, and 600mm ceilings.



Enclosure with Aruba AP555 Trim

In-Plane™ Collection

The In-Plane™ collection offers the simplest way to mount APs and antennas from most leading vendors into existing hard (drywall/sheet rock) ceilings up to 1.5" (38 mm) thick, for an aesthetic, professional installation. A cutout is made in the ceiling and the all metal back-box is fastened into the ceiling. The AP fastens to the appropriate trim, and the AP/trim attaches to the back-box with torsion springs. The AP is recessed into the ceiling much like a recessed light fixture, with only the front face exposed for optimal wireless coverage. The AP trim is easily swapped for new trim when AP brand or model changes.

- Performance: UL listed for low voltage applications and designed to meet NEC300-22 and 300-23 for plenum installations
- AP/antenna bracket and trim is interchangeable for other APs or antennas, without removing back-box. Trim attaches with torsion spring
- Solid back-box fills opening behind AP, creating an effective fire, smoke and dust barrier to simplify Infection Control Risk Assessment (ICRA) compliance
- De-rate AP operating temperature range by 18°F (10°C) when mounted in enclosure
- Adjustable hanger wire to support enclosure and installed equipment independent of the ceiling system
- Swivel fasteners secure enclosure into pre-existing hard ceiling panels .75" (19 mm) thick or less
- Firestop grommet for insertion into back-box, large enough for 2 Cat6A cables
- 1 in. trade size knockouts in two walls
- Maximum weight inside enclosure is 25 lb (11.3 kg)
- Back-box size: 3"H x 11" x 11" (76 mm x 280 mm x 280 mm)
- Trim: 13.5" x 13.5" (343 mm x 343 mm)
- Weight: 5 lb (2.3 kg)
- Material: Steel
- Finish: White



For additional technical detail, visit: oberonwireless.com. Or contact Oberon at sales@oberonwireless.com or 1-877-867-2312.

Part Number	Description	Shipping Weight lb (kg)
1042-ARAP635	Enclosure with Aruba AP635 Trim	6 (2.7)
1042-ARAP555	Enclosure with Aruba AP555 Trim	6 (2.7)
1042-ARAP535	Enclosure with Aruba AP535 Trim	6 (2.7)
1042-COAP9136	Enclosure with Cisco 9136 Series AP Trim	6 (2.7)
1042-COAP9130	Enclosure with Cisco 9130 Series AP Trim	6 (2.7)
1042-COAP9120	Enclosure with Cisco 9120 Series AP Trim	6 (2.7)
1042-COAP9115	Enclosure with Cisco 9115 Series AP Trim	6 (2.7)

Note: Enclosures do not include access points. Enclosure covers are cut to fit specific access points. Other options available for other access points.

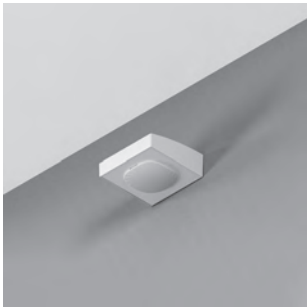

Right Angle Wall-Mount with Aruba AP635 trim



For additional technical detail, visit: oberonwireless.com. Or contact Oberon at sales@oberonwireless.com or 1-877-867-2312.

H-Plane™ Collection

Many Wi-Fi Access Point (AP) manufacturers recommend APs be mounted in a horizontal orientation for optimal wireless coverage. In locations where the APs are mounted on the wall, Oberon's 1007 series H-Plane™ right angle wall mounts permit the AP to be mounted in the preferred horizontal orientation. With the 1007 series, the AP is partially recessed into the right angle mount, exposing only the antenna face of the AP, providing for the ideal combination of aesthetics and wireless coverage. A locking plastic cover on the back secures and conceals cabling and connectivity, providing for a nicely finished installation. The 1007-LPDOME/-FPDOME models have a plastic dome which conceals and secures the AP.

- AP is partially recessed into mount, revealing only AP antenna face
- AP can be secured using manufacturer's locking features
- Construction: White ABS Plastic Right Angle Wall Mount, 8 ga. White Powder Coated Aluminum Trim
- Size: 5"H x 14.3"W x 14.2"L (127 mm x 363 mm x 362 mm)
- Weight: 5 lb (2.3 kg)
- Material: ABS Plastic Right Angle Wall Mount, 8 ga. Aluminum Trim
- Finish: White

Part Number	Description	Shipping Weight lb (kg)
1007-ARAP635	Right Angle Wall Mount with Aruba AP635 trim	6 (2.7)
1007-ARAP555	Right Angle Wall Mount with Aruba AP555 trim	6 (2.7)
1007-ARAP535	Right Angle Wall Mount with Aruba AP535 trim	6 (2.7)
1007-COAP9136	Right Angle Wall Mount with Cisco 9136 Series AP trim	6 (2.7)
1007-COAP9130	Right Angle Wall Mount with Cisco 9130 Series AP trim	6 (2.7)
1007-COAP9120	Right Angle Wall Mount with Cisco 9120 Series AP trim	6 (2.7)
1007-COAP9115	Right Angle Wall Mount with Cisco 9115 Series AP trim	6 (2.7)

Note: Right Angle Wall Mounts do not include access points. Right Angle Wall Mounts are cut to fit specific access points. Other options available for other access points and versions with domes.



Enclosure (cover removed) with Aruba AP

Skybar™ Collection

These NEMA 4 enclosures are designed specifically to protect and conceal APs, antennas, and cabling in environments where aesthetics is paramount, and typical 'industrial' NEMA 4 enclosures are not acceptable due to their appearance. Skybar enclosures feature a shaped lid with recessed screws and internal mounting features for most vendor's APs and antennas. This rugged polycarbonate enclosure protects the AP from weather, pressure spray, spilling liquids, dust, and impacts, and is transparent to wireless signals. Skybar enclosures are paintable. Auxiliary antenna and pole mounting brackets are also available.

NOTE: 6 GHz Access Points (e.g. Wi-Fi 6E) may only operate outdoors in the United States in the Standard Power mode (requiring AFC coordination). Low Power Indoor (LPI) Access Points are restricted to indoor only operation.

- Performance: Designed to NEMA 1, 2, 4, 4X, 12, and 13, and IEC529-IP66 specifications for indoor/outdoor wet, dirty, or corrosive environments. UV-stabilized for exposure to direct sunlight. Transparent to wireless signals. Paintable. Model 1020 and 1022 have NEMA PW ancillary rating for power washing environments.
- Oberon Skybar™-shaped screw on cover with gasket; cover screws must be torqued to 8 in-lb (0.90 N-m); cover screws are recessed into cover
- Includes internal universal T-bar bracket and universal mounting panel
- For model 1020, AP max. operating temperature should be de-rated by 19.8°F (11°C) inside the enclosure, when solar loading is not present
- For model 1021 and 1022, AP max. operating temperature should be de-rated by 9°F (5°C) inside the enclosure, when solar loading is not present
- For outdoor installation, the enclosures are white or light gray to reduce solar loading. Painting the enclosure a darker color will increase solar loading. Avoid mounting the enclosure where it is directly exposed to the sun. Temperature rating: -40°F to 248°F (-40°C to 120°C)
- Material: UL 94 V-0 Polycarbonate Enclosure and cover, UL 94-HB ABS Plastic Universal Mounting Panel, UL 94-HB ABS Plastic Wall Mount Brackets, 18 Ga. Powder Coated Steel T-bar Bracket
- Finish: White or gray enclosure, white T-bar bracket
- 1020-00, Exterior Size: 13.4"H x 9.3"W x 4.0"D (340 mm x 236 mm x 100 mm). Interior dimensions: 10.7"H x 9"W x 3.6"D (272 mm x 229 mm x 93 mm)
- 1021-00, Exterior Size: 21"H x 13.5"W x 5.5"D (533 mm x 343 mm x 140 mm). Interior dimensions: 19.4"H x 12"W x 4.9"D (493 mm x 305 mm x 124 mm)
- 1022-00, Exterior Size: 14.7"H x 11.4"W x 6.4"D (373 mm x 290 mm x 163 mm).



For additional technical detail, visit: oberonwireless.com. Or contact Oberon at sales@oberonwireless.com or 1-877-867-2312.

Part Number	Description	Shipping Weight lb (kg)
1020-00	NEMA 4 Plastic Wi-Fi Access Point Enclosure with Opaque Screw-On Cover, 13.4"H x 9.3"W x 4.0"D (340 mm x 236 mm x 100 mm)	3 (1.4)
1021-00	NEMA 4 Plastic Wi-Fi Access Point Enclosure with Opaque Screw-On Cover, 21"H x 13.5"W x 5.5"D (533 mm x 343 mm x 140 mm)	10 (4.5)
1022-00	NEMA 4 Plastic Wi-Fi Access Point Enclosure with Opaque Screw-On Cover, 14.7"H x 11.4"W x 6.4"D (373 mm x 290 mm x 163 mm)	5 (2.3)

Note: Enclosures do not include access points. Other options available including additional brackets to pole mount enclosure and external antennas.



Bollard (sectional view) with Aruba AP



For additional technical detail, visit: oberonwireless.com. Or contact Oberon at sales@oberonwireless.com or 1-877-867-2312.

Netpoint™ Collection

Oberon's Netpoint™ 3030 Wireless Bollard is ideal for extending wireless and Wi-Fi coverage into open public spaces such as parks, outdoor malls, and bus stops. The wireless bollard can be used to mount the Wi-Fi AP in locations where Wi-Fi coverage is needed most, and avoid mounting on buildings or light poles. This rugged fiberglass bollard is weatherproof and tamper resistant and is designed to protect wireless equipment in open public areas. The fiberglass construction is virtually transparent to wireless signal. Large enough for APs, omni-directional and directional antennas, and small network switches from most vendors.

NOTE: 6 GHz Access Points (e.g. Wi-Fi 6E) may only operate outdoors in the United States in the Standard Power mode (requiring AFC coordination). Low Power Indoor (LPI) Access Points are restricted to indoor only operation.

- Performance: Designed to protect equipment from tampering, abuse, and weather. NEMA 3R performance for indoor/outdoor environments. Fiberglass is virtually transparent to wireless signals
- Anchors to pre-installed concrete pedestal. Cabling is conducted through conduit in pedestal
- Available in 7 standard colors and custom colors. Paintable
- Includes anchor base, equipment stand, hardware to fasten APs and antennas. Bolt cover and tamper resistant hardware
- Construction: 0.25 in. thick centrifugal cast fiberglass composite bollard (65% glass, 35% resin). Paint is UV and cleaning chemical resistant. Zinc coated, 0.25 in. thick steel anchor base. Fiberglass equipment mounting stand. Color matched ABS plastic bolt cover.
- Size: 57 in. (1384 mm) above grade, 12.5 in. (318 mm) inner diameter. Anchor base is 15.25" x 15.25" (400 mm x 400 mm)
- Weight: 63 lb (28.6 kg)

Part Number	Description 12.5" Diam	Shipping Weight lb (kg)
3030-00-BK	Heavy Duty Fiberglass Bollard, Black	80 (36.3)
3030-00-BZ	Heavy Duty Fiberglass Bollard, Bronze	80 (36.3)
3030-00-BN	Heavy Duty Fiberglass Bollard, Brown	80 (36.3)
3030-00-GY	Heavy Duty Fiberglass Bollard, Gray	80 (36.3)
3030-00-LTGY	Heavy Duty Fiberglass Bollard, Light Gray	80 (36.3)
3030-00-FGN	Heavy Duty Fiberglass Bollard, Forest Green	80 (36.3)
3030-00-WH	Heavy Duty Fiberglass Bollard, White	80 (36.3)

Note: Bollards do not include access points. Other options available including additional brackets to mount antennas, workbox and anchors for the bollard.

SECTION 8

INDEX

Part Number	8-3
Alphabetical	8-8



*Learn about CPI's Standard Limited Warranty and Extended Limited Warranties.
See page vii for details.*

INDEX

CPI New Products and Product Enhancements

Cabinets & Containment

- ZetaFrame™ Cabinet and Accessories Page 1-5

Power Monitoring & Security

- Horizontal eConnect® PDUs:
 - Basic eConnect PDU Page 3-5
 - Monitored eConnect PDU Page 3-11
 - Monitored Pro eConnect PDU Page 3-14
 - Switched Pro eConnect PDU Page 3-20
- Uninterruptible Power Supplies (UPS) Page 3-49
 - Lithium Ion Standby UPS 350VA–600VA
 - Lead Acid Line–Interactive UPS 800VA–5000VA
 - Lithium Ion Online UPS 1500VA–3000VA
 - Lead Acid Online UPS 1000VA–3000VA
 - Lead Acid Online UPS 5000VA–10KVA

Wireless Enclosures

- Wi-Tile™ Collection Page 7-3
- In-Plane™ Collection Page 7-4
- H-Plane™ Collection Page 7-5
- Skybar™ Collection Page 7-6
- Netpoint™ Collection Page 7-7

PART NUMBER

Part #	Page	Description
1007	7-5	H-Plane Collection
1020	7-6	Skybar Collection
1021	7-6	Skybar Collection
1022	7-6	Skybar Collection
1042	7-4	In-Plane Collection
1047	7-3	Wi-Tile Collection
02004	5-30	Hex Bolts/Lag Screw
02006	5-30	Hex Bolts/Lag Screw
02007	5-30	Hex Bolts/Lag Screw
03001	5-29	Runway Hex Nuts
03003	5-23	Slip-On Lock Nut
04002	5-29	Runway Washers
04003	5-29	Runway Split Lock Washers
10001	2-73	Stand-Off Brackets
10175	2-35	Rollers
10250	5-3	Universal Cable Runway
10473	2-32	Top Angle
10487	5-13	Swivel Splice Kits
10506	5-17	Runway Elevation Kits
10557	5-23	Runway Threaded Rod Clamps
10559	2-73, 4-10	Stand-Off Brackets
10565	2-32	Rack Extension Kit
10575	5-20	Runway End Caps
10595	5-15	Runway Channel Rack Mounting Plate
10605	2-31, 4-8	Rack Base Insulator Kit
10607	5-24	Runway Slotted Support Bracket
10608	5-20	Runway Vertical Foot Brackets
10610	4-5	Busbar, Horizontal Rack Bond
10616	5-11	Adj Junction Splice Kit
10622	4-4	Busbar
10629	2-31	Raised Floor Support Kit
10630	2-31	Raised Floor Support Kit
10631	2-31	Raised Floor Support Kit
10632	2-31	Raised Floor Support Kit
10642	5-20	Runway End Caps
10684	5-26	Runway Tall Pipe Stand
10695	5-27	Runway Earthquake Bracing Kits
10696	5-27	Runway Earthquake Bracing Kits
10697	5-22	Runway Threaded Rod Coupling Kit
10702	5-26	Runway Spanner Kit
10723	5-10	Runway Radius Bend
10758	2-23	Small Peripheral 19"
10812	2-72	Closed Distribution Rings
10822	5-10	Runway E-Bend
10873	5-24	Runway Slip-On Support Bracket
11054	2-24	26" Deep Shelf
11085	5-22	Runway Threaded Rod Cover
11164	2-26	Heavy-Duty Shelf
11231	2-25	Double-sided Shelf
11268	5-21	Runway L-Bracket
11275	5-3	UL Classified Runway
11293	2-23	Low Profile Shelf
11294	2-24	Low Profile Shelf
11298	5-13	Heavy-Duty Butt Splice Kit
11299	5-12	Heavy-Duty Butt Splice Kit
11301	5-11	Butt Splice Kit

Part #	Page #	Description
11302	5-11	Junction Splice Kit
11308	5-19	Runway J-Bolt Kit
11309	5-20	Runway Foot Kit
11310	5-25	Runway Threaded Ceiling Kit
11312	5-18	Runway Support Bracket
11313	5-12	45" Splice Kit
11314	5-12	90" Splice Kit
11359	2-25	Low Profile Shelf
11374	2-64	Wide vertical Cabling Section
11406	5-23	Runway Ceiling Support Bracket
11408	5-24	Runway Support Bracket
11415	2-26	Sliding Shelf
11421	5-19	Runway Wall Angle Kit
11430	5-28	Runway J-Bolts
11440	5-22	Runway Threaded Drop Rods
11487	2-29	Monitor Shelf/Tray
11520	2-39	Hinges, Mounting Bracket
11521	2-39	Hinged Panel Mounting Bracket
11522	2-39	Hinged Panel Mounting Bracket
11523	2-39	Hinged Panel Mounting Bracket
11524	2-39	Hinged Panel Mounting Bracket
11525	2-39	Hinged Panel Mounting Bracket
11554	2-35	Rollers
11564	2-30	19" Keyboard Tray
11564	2-71	Large Horizontal Ring Panel
11582	2-33	Rack Seismic Gusset Kit
11583	2-40	Flush Mount Wall Bracket
11643	2-35	Dolly
11700	5-21	Runway End Closing Kit
11730	2-64	Narrow Vertical Cabling Section
11746	5-18	Runway Support Bracket
11752	2-71	Rack Cabling Managers
11754	2-40	Flush Mount Wall Bracket
11760	2-31	Raised Floor Support Kit
11761	2-31	Raised Floor Support Kit
11762	2-31	Raised Floor Support Kit
11763	2-31	Raised Floor Support Kit
11764	2-71	Slip-On Cover Ring Panel
11790	2-42	Standard Swing Gate Rack
11791	2-42	Standard Swing Gate Rack
11793	2-42	Standard Swing Gate Rack
11794	2-42	Standard Swing Gate Rack
11795	2-42	Standard Swing Gate Rack
11807	2-42	Standard Swing Gate Rack
11837	1-40	CUBE-IT Wire Management Bar
11840	1-34	CUBE-IT Wall-Mount Cabinet
11890	1-34	CUBE-IT Wall-Mount Cabinet
11901	1-34	CUBE-IT Wall-Mount Cabinet
11911	5-14	Runway Wall to Rack Kit
11913	1-24	32"D Sliding Shelf
11914	1-24	32"D Sliding Shelf
11922	2-65	Cabling Section Cover
11923	2-65	Cabling Section Cover
11927	2-37	RMU Labels
11959	5-14	Runway Corner Bracket
11960	2-43	Fixed Wall-Mount Equipment Rack

PART NUMBER

Part #	Page #	Description
11961	2-43	Fixed Wall-Mount Equipment Rack
11962	2-43	Fixed Wall-Mount Equipment Rack
11963	2-43	Fixed Wall-Mount Equipment Rack
11964	2-43	Fixed Wall-Mount Equipment Rack
11965	2-43	Fixed Wall-Mount Equipment Rack
11972	2-42	Standard Swing Gate Rack
11996	1-34	CUBE-IT Wall-Mount Cabinet
12096	2-64	Narrow Vertical Cabling Section
12100	5-7	Cable Runway Radius Drop
12101	5-7	Cable Runway Radius Drop
12115	5-7	Runway Movable Cross Member
12121	5-16	Runway Channel Rack Mounting Plate
12127	2-72	Closed Distribution Rings
12176	2-69	Patch Panel Wire Bar
12183	2-70	Jumper Tray
12185	2-70	Jumper Tray
12186	2-70	Transition Plate
12187	2-70	Jumper Tray
12193	2-30	Full Size Keyboard/Mouse Tray
12291	2-44	Shelf/Wall-Mount Rack
12293	2-26	Heavy-Duty Shelf
12309	2-38	Rack Channel Standoffs
12310	2-38	Rack Channel Standoffs
12311	2-38	Rack Channel Standoffs
12312	2-37	Equipment Support Rack
12334	1-22	Fixed Shelf
12335	1-22	Fixed Shelf
12336	1-22	Fixed Shelf
12337	1-22	Fixed Shelf
12338	1-23	Sliding Shelf
12339	1-23	Sliding Shelf
12345	1-23	Sliding Shelf
12346	1-23	Sliding Shelf
12362	5-25	Runway Center Support
12370	2-65	Finger Snap Cable Guides
12409	5-16	Runway Channel Rack Mounting Plate
12418	5-15	Runway Channel Rack Mounting Plate
12419	1-34	CUBE-IT Wall-Mount Cabinet
12541	2-69	Horizontal Wire Panel
12542	2-69	Horizontal Wire Panel
12573	1-23	Low Profile Fixed Shelf
12610	1-23	Low Profile Fixed Shelf
12637	2-20	Hardware Kits
12638	2-20	Hardware Kits
12639	2-20	Hardware Kits
12664	2-65	Cabling Section Cover
12700	2-19	Extra Heavy Sliding Shelf
12717	2-29	Flush Mount Keyboard Tray
12730	5-15	Runway Channel Rack Mounting Plate
12731	5-16	Runway Channel Rack Mounting Plate
12751	2-27	anyServer Bracket
12752	2-27	anyServer Bracket
12759	2-27	anyServer Bracket
12766	2-67	Fiber Management Spools
12787	1-35	CUBE-IT Mounting Kit
12795	2-42	Swing Gate Brackets

Part #	Page #	Description
12803	1-40	CUBE-IT/LED Kit Kit
12816	2-45, 3-32	Power Strips
12820	1-40, 3-32	Power Strips
1283X	2-63	Global Vertical Cabling Section
12836	2-63	GVCS Cable Rings
12848	3-31	Power Strips
12850	3-31	Power Strips
12858	2-41	Corner Cushions
12891	2-66	Extended Fingers Bracket
12934	1-42	Surge-Suppressed Receptacle/ThinLine
12955	1-41	Fiber Slack Panel Mgr/ThinLine
13050	1-41	ThinLine II Wall-Mount Cabinet
13051	1-42	Intelligent Fan Kit/ThinLine
13070	2-69	Horizontal Wire Panel
13082	2-28	Lockable Storage Drawer
13083	2-28	Lockable Storage Drawer
13084	2-28	Lockable Storage Drawer
13239	3-32	Power Strips
13285	1-40	CUBE-IT/Power Strip
13392	5-8	Runway Dividers
13395	5-9	Runway PatchRack
13396	5-9	Runway PatchRack
13399	5-9	Runway PatchRack
13483	1-35	CUBE/Foot Kit
13492	1-36	CUBE-IT Floor-Supported Cabinet
13493	1-36	CUBE-IT Floor-Supported Cabinet
13495	1-37	CUBE-IT Floor-Supported Cabinet
13496	1-37	CUBE-IT Floor-Supported Cabinet
13515	2-31	Raised Floor Support Kit
13517	1-22	Rack-Mount Cable Shelf
13602	2-41	EasySwing Wall-Mount Rack
13604	2-41	EasySwing Wall-Mount Rack
13608	2-41	EasySwing Wall-Mount Rack
13622	4-3	Busbar
13671	1-9, 1-20	Raised Floor Grommets
13696	2-12	SeismicFrame Cable Fingers Kit
13697	2-12	SeismicFrame Vertical Power Strip
13698	2-12	SeismicFrame Duplex Outlet Box
13730	5-15	Runway Channel Rack Mounting Plate
13731	5-16	Runway Channel Rack Mounting Plate
13772	1-44	Zone Raised Floor Enclosure
13812	1-46	Zone Ceiling Enclosure
13812	1-47	Zone Patch Panel Enclosure
13853	2-11	SeismicFrame Two-Post Rack
13854	2-11	SeismicFrame Two-Post Rack
13855	2-11	SeismicFrame Two-Post Rack
13856	2-11	SeismicFrame Two-Post Rack
13883	2-11	SeismicFrame Two-Post Rack
13884	2-11	SeismicFrame Two-Post Rack
13885	2-11	SeismicFrame Two-Post Rack
13886	2-11	SeismicFrame Two-Post Rack
1390X	2-58	Velocity Cable Managers, SS
1391X	2-58	Velocity Cable Managers, DS
13928	2-59	Velocity Cable Lashing Bar
13930	2-59	Velocity Horizontal CM
13934	2-59	Velocity Cable Ring Manager

PART NUMBER

Part #	Page #	Description	Part #	Page #	Description
13935	2-59	Velocity Cable Spool Kit	17762	3-38	PDU Accessories
14070	1-22	Fixed Shelf	17763	3-38	PDU Accessories
14072	1-22	Fixed Shelf	20015	5-28	Runway Split Lock Washers
14300	5-4	Adjustable Cable Runway	20098	5-28	Hex Bolts/Lag Screw
14304	5-6	Tool-less Cross Member	20141	5-29	Runway Split Lock Washers
14305	5-6	Tool-less Stringer Radius Drop	20142	5-29	Runway Hex Nuts
14307	5-5	Adj Cable Runway Bonding Strap	20283	5-29	Runway Washers
14308	5-8	Tool-less Pathway Dividers	20290	5-30	Hex Bolts/Lag Screw
14435	1-18	Z4-Series Air Dam Kit	25190	1-35	CUBE iT Cable Top Brush Kit
14440	1-19	Z4-Series Ring Cable Mgr	25400	2-34, 5-28	Runway Touch Up Paint
14445	1-19	Z4-Series Ring Cable Mgr	25401	5-28	Runway Touch Up Paint
14465	1-18	Z4-Series Cable Lashing Bracket	3030	7-7	Netpoint Collection
14480	1-19	Z4-Series Full Height PDU Bracket	30013	2-39	Block Mounting Bar
14481	1-19	Z4-Series Full Height PDU Bracket	30014	2-39	Block Mounting Bar
14485	1-18	Z4-Series Front to Rear Cable Manager	30015	2-39	Block Mounting Bar
14655	3-47	RFID Lock Sensors	30016	2-39	Block Mounting Bar
14665	1-13	Temperature/Humidity Sensor	3002X	2-34	Filler Panels
14666	1-13, 3-46	eConnect RFID Electronic Lock Kit	3009X	2-60	MCS Master Cabling Section/Vertical
14667	3-47	eConnect RFID Electronic Lock Kit	3016X	2-61	CCS Combination Cabling Section/Vertical
14676	3-29	eConnect Field-Replaceable Module	30529	2-68	Universal Horizontal Cable Manager
14812	3-29	eConnect Field-Replaceable Module	30530	2-68	Universal Horizontal Cable Manager
15008	2-67	Cable Distribution Spools	30531	2-68	Universal Horizontal Cable Manager
15053	2-20	QuadraRack Server Frame	31410	2-37	Rack Panel Adapters
1521X	2-17	Adjustable 4-Post Rack	31420	2-37	Rack Panel Adapters
1525X	2-13	Adjustable Rail 4-Post Rack	31430	2-37	Rack Panel Adapters
1532X	2-40	Wall-Mount Equipment Rack	31440	2-37	Rack Panel Adapters
15235	2-19	Adjustable 4-Post Equipment Rails	31450	2-37	Rack Panel Adapters
15259	2-15	Adjustable Rail/Fixed Rail	31470	5-18	Runway Support Bracket
15260	2-15	Adjustable Rail/Fixed Rail	31473	5-14	Runway Wall to Rack Kit
15270	2-15	Adjustable Rail/Side Panels	32573	2-48	Motive Vertical Cable Manager
15275	2-15	Top-Mount Waterfall Tray	32601	2-49	Motive PDU Bracket
15285	2-15	Adjustable Rail/Equipment Rail	32602	2-49	Motive/Side Panel Kit
15330	2-19	Center Rails	3261X	2-46	Motive Cable Manager/Single-Sided
15335	2-19	Center Rails	3262X	2-46	Motive Cable Manager/Double-Sided
15555	2-29	Flush Mount Sliding Keyboard	32650	2-46	Motive Accessory Rod Assembly
15556	2-29	Flush Mount Sliding Keyboard	32651	2-47	Motive Half Spool Kit
15640	3-37	International Power Strips	32657	2-47	Motive Finger Kit
15642	3-34	International Power Strips	32661	2-47	Motive/Finger Kit
15643	3-35	International Power Strips	32697	2-48	Motive Tool-less Radius Bend
15644	3-35	International Power Strips	32770	1-26	AC/Door Assembly
15645	3-36	International Power Strips	32780	1-26	AC/Door Assembly
16298	5-13	Heavy-Duty Butt Splice Kit	32805	1-27	Containment Door Mounting Bracket
16299	5-12	Heavy-Duty Butt Splice Kit	32817	1-28	Containment Door Top Seal Kit
16301	5-11	Butt Splice Kit	32870	1-27	Containment Door Stanoff Kit
16302	5-11	Junction Splice Kit	32875	1-27	Containment Floor Mounting Template
16313	5-12	45° Splice Kit	33000	1-31	BTS Kits
16314	5-12	90° Splice Kit	33001	1-32	BTS/Corrugated Cutter
16341	2-22	Rack Dust Cover	33002	1-32	BTS/Blanking Panel
16342	2-22	Line-Up Spacer	33003	1-32	BTS/Bulb seal
16350	2-22	4-Post Heavy-Duty Shelf	34537	1-9	Snap In Filler Panels
16351	2-22	4-Post Heavy-Duty Shelf	34538	1-9	Snap In Filler Panels
16356	2-22	Equipment Tie-Down Bracket	34573	2-53	Cable Lashing Bar
16487	5-13	Swivel Splice Kits	35431	2-50	Motive Horizontal Cable Manager
17000	2-73	Mag-Clips	35432	2-50	Motive Horizontal Cable Manager
17100	2-73	Mag-Clips	35441	2-56	Evolution Horizontal CM
17500	2-73	Mag-Clips	35442	2-56	Evolution Horizontal CM

PART NUMBER

Part #	Page #	Description
35475	2-53	Evolution Fiber Segregation Kit
35492	2-55	Evolution Fixed Access Panel
35493	2-55	Evolution Movable Mid Section
35497	2-54	Evolution Solid Mid-Panel
35501	2-54	Evolution Solid Rear Panel
35503	2-53	Evolution Cable Divider Kit
35505	2-55	Evolution Cable Distribution Spools
35506	2-55	Evolution Floor Bracket
3551X	2-52	Evolution g1 Vertical CM
3552X	2-52	Evolution g2 Vertical CM
3557X	2-52	Evolution g3 Vertical CM
35700	3-38	PDU Accessories
36516	3-30	Power IQ for eConnect
36603	3-30	Power IQ for eConnect
36604	3-30	Power IQ for eConnect
36605	3-30	Power IQ for eConnect
36651	1-13, 3-46	RFID Lock Sensors
36652	1-13, 3-46	RFID Lock Sensors
36653	1-13, 3-46	RFID Lock Sensors
36654	1-13, 3-46	RFID Cards
37008	6-19	RMR Busbar Kit
37009	6-19	RMR Grounding Lug Kit
37045	6-16	RMR Quick Mounting Kit
37049	6-17	RMR Lag Bolt Mounting Kit
37065	6-16	RMR Equipment Mounting Rails
37067	6-16	RMR Equipment Mounting Rails
37075	6-17	RMR Mounting Plates
37076	6-17	RMR Mounting Plates
37082	6-18	RMR Vertical Lashing Bracket
37084	6-19	RMR Front-To-Rear Lashing Bracket
37086	6-18	RMR Short Finger Cable Manager
37097	6-19	RMR Cable Entry Grommet
37101	6-32	RMR Thermal Filter Fan
37115	6-34	RMR EPDM Grommet
37116	6-32	RMR Replacement Filter
37117	6-32	RMR Replacement Filter
37739	6-11	RMR Document Holder
37770	6-11	RMR Baying Support Slides
37771	6-5	RMR Equipment Mounting Rails
37772	6-5	RMR Equipment Mounting Rails
37774	6-5	RMR Equipment Mounting Rails
37775	6-5	RMR Equipment Mounting Rails
37777	6-10	RMR Bracket for Baying Plate
37780	6-9	RMR Full-Height Mounting Plate
37787	6-10	RMR Full-Height Baying Mounting Plate
37800	6-6	RMR Cable Lashing Bracket
37801	6-8	RMR Ring Cable Manager
37803	6-8	RMR Short Ring Cable Manager
37808	6-7	RMR Dual PDU Bracket
37809	6-7	RMR Dual PDU Bracket
37820	6-11	RMR Baying Scissors Kit
37823	6-11	RMR Eyebolt Baying Kit
37825	6-11	RMR Internal Baying Kit
37830	6-6	RMR Enclosure Plinth Base
37840	6-9	RMR Half-Height Mounting Plate
37850	6-7	RMR Finger Cable Manager

Part #	Page #	Description
37842	6-8	RMR Qtr Height Mounting Plate
37860	6-7	RMR Finger Cable Manager
37865	6-7	RMR Finger Cable Manager
37898	6-32	RMR Filter Kits
37900	6-33	RMR Closed Loop Cooling
37901	6-33	RMR Closed Loop Cooling
37903	6-32	RMR Thermal Filter Fan Power Cord
37908	6-33	RMR Closed Loop Cooling Power Cord
37912	6-34	RMR Sealing System
37913	6-34	RMR Sealing System
37914	6-34	RMR Sealing System
37915	6-34	RMR Sealing System
37920	6-31	RMR Thermal Filter Fan
37921	6-31	RMR Thermal Filter Fan
37940	6-10	RMR Hardware Kits
38634	1-11	Cable Lashing Panel
38635	1-11	Cable Lashing Panel
38636	1-11	Cable Lashing Panel
38637	1-12	PDU Bracket
38638	1-12	PDU Bracket
38645	3-39	PDU Accessories
38646	1-10	Vertical Cable Manager
38647	1-10	Vertical Cable Manager
38648	1-11	Front to Rear Cable Manager
38649	1-7	Air Dam Kit
39076	1-14	Cabinet Seal Kit
39137	1-14	Cabinet Bay Seal Kit
39150	1-14	Cabinet Adjustment Tool Kit
39207	1-14	Cabinet Ramp Kit
39716	1-8	Equipment Mounting Rail
39731	1-8	Equipment Mounting Rail
39763	1-7	Side Panels
39774	1-7	Side Panels
39802	1-13	Air Director
39835	1-10	Vertical Cable Manager
39996	1-8	Floor Seal Kits
39997	1-8	Floor Seal Kits
40074	2-23	Single-Sided Shelf
40074	2-45	Shelf/Wall-Mount Rack
40075	2-23	Single-Sided Shelf
40098	2-62	CCS-EFX Combo Cabling Section/Vertical
40099	2-62	CCS-EFX Combo Cabling Section/Vertical
40100	2-62	CCS-EFX Combo Cabling Section/Vertical
40108	2-25	Double-Sided Shelf
40117	2-23	Single-Sided Shelf
40118	2-23	Single-Sided Shelf
40150	4-3	Busbar
40156	4-5	Busbar Assemblies
40157	4-8	Busbar Insulator Block
40158	4-5	Busbar Assemblies
40159	4-7	Bonding Jumper Kit, Rack
40159	4-9	Equipment Jumper Kit
40159	4-10	Ground Wire
40159	1-38	CUBE iT Bonding Jumper Kit
40160	4-6, 6-11	Busbar, Vertical Bond
40161	4-7	Busbar, Vertical Rack Kit

PART NUMBER

Part #	Page #	Description
40162	4-13	Compression Lugs
40163	4-12	C-Type Compression Taps
40164	4-9	Bonding Strap, Runway
40165	4-13	Compression Tools
40166	4-14	Antioxidant Joint Compound
40167	4-8	Two-Hole Ground Terminal Block
40168	4-14	Copper to Copper Joint Compound
40169	4-11	Pedestal Clamp/Bonding Connector
40170	4-11	Pipe Clamp/Bonding Connector
40172	4-6	Busbar, Vertical Rack Kit
40604	2-31	Rack & Frame Install Kit
40605	4-14	Clean Thread Screws
40605	2-39	Mounting Screws
40607	2-31	Installation Kit
40750	2-24	Standard Single-Sided Shelf
40751	2-24	Standard Single-Sided Shelf
40970	1-39	CUBE iT Vertical Cabling Section
40971	1-40	CUBE iT Vertical Lashing Bracket
40972	1-38	CUBE iT Standard Fan & Filter
40973	1-38	CUBE iT Low Decible fan Kit
40974	1-40	CUBE iT Shelf
40975	1-38	CUBE iT Low Decible fan Kit
41050	2-36	Rack Dust Covers
42050	2-36	Rack Dust Covers
460XX	2-4	Universal Rack
463XX	2-4	Universal Rack
467XX	2-4	Universal Rack
483XX	2-4	Universal Rack
50120	2-21	QuadraRack 4-Post Frame
55053	2-5	Standard Rack 3'D
57001	2-8	Global Standard Pack
57002	2-8	Global Standard Pack
57003	2-8	Global Standard Pack
57004	2-8	Global Standard Pack
57011	2-9	Velocity Stadarad Pack
57012	2-9	Velocity Stadarad Pack
57013	2-9	Velocity Stadarad Pack
57014	2-9	Velocity Stadarad Pack
60100	3-44	RIM-750 Module
60101	3-42	RIM-1000 Models
60103	3-40	RIM-1000 Unit
60106	3-39	RIM Protocol Converter
60107	3-45	RIM Rack-Mount Bracket
60108	3-45	RIM-750 Sensors
60109	3-43	RIM-1000 Sensors
60110	3-43	RIM-1000 Sensors
60111	3-43	RIM-1000 Sensors
60113	3-43	RIM-1000 Sensors
60114	3-43	RIM-1000 Sensors
60115	3-43	RIM-1000 Sensors
60507	5-17	Pathway Elevation Kits
60508	5-17	Pathway Elevation Kits
66353	2-6	Standard Rack 6'D
76543	1-21, 2-20	Click-Nut Hardware Kit
76544	1-21, 2-20	Click-Nut Hardware Kit
76545	1-21, 2-20	Click-Nut Hardware Kit

Part #	Page #	Description
A0124-PP	1-47	Patch Panel Enclosure
A0222-RF	1-44	Raised Floor Enclosure
A04-XXXX	6-21	RMR Floor-Mount Enclosure
A0422-RF	1-44	Raised Floor Enclosure
A05-XXXX	6-21	RMR Floor-Mount Enclosure
A06-XXXX	6-23	RMR Free-Standing Enclosure
A0622-RF	1-44	Raised Floor Enclosure
A07-XXXX	6-23	RMR Free-Standing Enclosure
A08-XXXX	6-24	RMR Free-Standing Enclosure
A0802-RF-DI	1-45	Raised Floor Enclosure
A0822-RF-F	1-45	Raised Floor Enclosure
A09-XXXX	6-24	RMR Free-Standing Enclosure
A1-XXXX	6-4	RMR Modular Enclosure
A10-XXXX	6-25	RMR Free-Standing Enclosure
A1024-HR	1-46	Ceiling Enclosure
A1024-LP	1-47	Wiring Blocks
A11-XXXX	6-27	RMR Standard Wall-Mount Enclosure
A12-XXXX	6-28	RMR Standard Wall-Mount Enclosure
A1222-HR	1-46	Ceiling Enclosure
A1222-PP	1-47	Patch Panel Enclosure
A1224-HR	1-46	Ceiling Enclosure
A1224-LP	1-47	Wiring Blocks
A1224-PP	1-47	Patch Panel Enclosure
A13-XXXX	6-28	RMR Standard Wall-Mount Enclosure
A1411-RF-HR	1-45	Raised Floor Enclosure
A1422-RF	1-44	Raised Floor Enclosure
A1422-RF-F	1-45	Raised Floor Enclosure
A2-XXXX	6-15	RMR Fixed Wall-Mount Enclosure
A3-XXXX	6-13	RMR Swing Wall-Mount Enclosure
BCE-48-N	1-48	Basic Consolidation Enclosures
BCE-48-P	1-48	Basic Consolidation Enclosures
BCE-6-P	1-48	Basic Consolidation Enclosures
BCE-24P	1-48	Basic Consolidation Enclosures
BDMXX	3-64	UPS Bypass Distribution Modules
Chrome Lock	1-49	Service Parts
DF0021	6-29	RMR Swing-Out Plate kit
DF0022	6-29	RMR Door Stop Kit
DF0023	6-29	RMR Bonding Kit
DF0024	6-29	RMR Mounting Bracket Kit
DF0025	6-30	RMR Threaded Drain Plug Kit
DF0028	6-30	RMR XL Polyvent Kit
DF0030	6-30	RMR LED Light Kit
DF0031	6-30	RMR LED Light Kit
DF0032	6-29	RMR Swing-Out Plate kit
DF0033	6-29	RMR Swing-Out Plate kit
ED-XXXX	3-7	Basic eConnect PDU
E1-XXXX	3-10	Metered eConnect PDU
EA-3XXX	3-12	Monitored eConnect PDU
EA-4XXX	3-16	Monitored Pro eConnect
EA-5XXX	3-21	Switched eConnect PDU
EA-6XXX	3-24	Switched Pro eConnect PDU
L1-XXXX	3-66	Extended Limited Warranties
LD-Series	3-54	Lithium Online UPS 1500-300 VA UPS
LS-Series	3-49	Lithium Stand By 350-600VA UPS
RF-Bracket	1-49	Service Parts

Part #	Page #	Description
SNMP	3-63	UPS Communications Card
Spare Keys	1-49	Service Parts
UPSBRKT	3-65	UPS Mounting Bracket
UPSRAILKIT	3-65	UPS Rail Kit
UPSSHELFKIT	3-65	UPS Shelf
VD-Series	3-57	Lead Acid Online 1000-3000VA UPS
VD-Series	3-60	Lead Acid Online 5000-10kVA UPS
VL-Series	3-51	Lead Acid Interactive 800-5000VA UPS
VXBPX	3-63	UPS Accessories/Battery Pack
Wire Cage	1-50	Wire Cage Enclosure
XMERPDUX	3-65	UPS Isolation Transformer
Z1XXX	1-4	ZetaFrame Cabinet System
Z4-XXX	1-16	Z4-Series SeismicFrame Cabinet

Description	Page #
A	
<u>Aisle Containment</u>	
Door Assembly	1-26
Door Mounting Bracket	1-27
Door Standoff Kit	1-27
Door Top Seal Kit	1-28
Floor Mounting Template	1-27
BTS (HAC)	1-29
BTS Kits	1-31
BTS Blanking Panels	1-32
BTS Bulb Seal	1-32
BTS Corrugated Cutter	1-32
anyServer Bracket	2-27
Adjustable Cable Runway	5-4
B	
<u>Bonding & Grounding</u>	
ACR Bonding Strap	5-5
Antioxidant Joint Compound	4-14
Busbar	4-3
Busbar Assemblies	4-5
Busbar Insulator Block	4-8
Busbar, Horizontal Rack Bond	4-5
Busbar, Vertical Rack Kit	4-6
Bonding Jumper	4-10
Bonding Jumper Kit, Rack	4-7
Bonding Strap, Runway	4-9
C-Type Compression Taps	4-12
Compression Lugs	4-13
Compression Tools	4-13
Equipment Jumper Kit	4-9
Grounding wire	4-10
Ground Terminal Block	4-8
C	
<u>Cabinets</u>	
ZetaFrame Cabinet	1-4
Air Dam Kit	1-7
Air Director	1-13
Bay Seal Kit	1-14
Click-Nut Hardware Kits	1-6
Cable Lashing Panel	1-11
Cable Port Brush Kits	1-9
Equipment Mounting Rail	1-8
Floor Seal Kits	1-8
Front to Rear Cable Manager	1-11
Humidity Temperature Sensors	1-13
Leveling Feet	1-6
Lockable Storage Drawer	1-20
PDU Bracket	1-12
Raised Floor Grommets	1-9
Ramp Kit	1-6
RFID Lock Kit	1-13
Side Panels	1-7
Snap-In Filler Panels	1-9
Standard PDU Bracket	1-12
Vertical Cable Manager	1-10

Description	Page #
C	
Cabinets	
Z4-Series SeismicFrame Cabinet	1-16
Air Dam Kit	1-18
Cable Lashing Bracket	1-18
Fixed Shelf	1-22
Front to Rear Cable Manager	1-18
Full Height PDU Bracket	1-19
Low Profile Shelf	1-23
Raised Floor Grommets	1-20
Ring Cable Manager	1-19
Sliding Shelf, 32"D	1-24
Cabinets (Wall-Mount)	
CUBE-iT Wall Mount Cabinet	1-33
CUBE-iT Wall Mount Floor-Supported Cabinet	1-36
CUBE-iT Cable Port Brush Kit	1-35
CUBE-iT Low Decible Fan Kit	1-38
CUBE-iT Foot Kit	1-38
CUBE-iT Jumper Kit	1-35
CUBE-iT Lashing Bracket	1-40
CUBE-iT LED Light Kit	1-40
CUBE-iT Mounting Kit	1-35
CUBE-iT Power Strip	1-40
CUBE-iT Wire Management Bar	1-40
ThinLine II Wall-Mount Cabinet	1-41
ThinLine II Fan Kit	1-42
ThinLine II Surge-Suppression Receptacle	1-42
Cable Management	
CCS Combination Cabling Section	2-61
Evolution Cable Management	2-52
Global Vertical Cabling Section	2-63
MCS Master Cabling Section	2-60
Motive Cable Management	2-46
Motive Horizontal Cable Managers	2-50
Velocity Cable Manager	2-58
Universal Horizontal Cable Managers	2-68
Vertical Cabling Section	2-64
Cable Management Accessories	
Accessory Rod Assembly, Motive	2-46
Cable Distribution Spools	2-67
Cable Lashing Bar, Velocity	2-59
Cable Rings for GVCS	2-63
Cabling Section Covers	2-65
Click-Nut Hardware Kit	2-20
Distribution Spools, Evolution	2-55
Divider Kit	2-53
Extended Fingers Bracket	2-66
Fiber Management Spools, 2"	2-67
Fiber Segregation Kit, Evolution	2-53
Finger Kit, Motive	2-47
Finger Snaps Cable Guides	2-65
Half Spool Kit, Motive	2-4
Horizontal Wire Mgmt Panel for VCS	2-69
Jumper Tray	2-70
Large Horizontal Ring Panel	2-71

Description	Page #
C	
Cable Management Accessories	
Lashing Bar, Evolution	2-53
Mag Clips	2-73
Metal D-Rings	2-72
Movable Mid Section, Evolution	2-55
Patch Panel Wire Bar	2-69
PDU Bracket	2-49
Rack Cabling Managers	2-71
Slip-On Cover Ring Panel	2-71
Solid Mid Panel, Evolution	2-54
Stand Off Brackets	2-73
Tool-less Radius Bend, Evolution	2-53
Tool-less Radius Kit	2-66
Transition Plate	2-70
Cable Pathway	
Adjustable Cable Runway	5-4
UL Classified Cable Runway	5-3
Universal Cable Runway	5-3
Cable Pathway Accessories	
45° Runway Splice Kit	5-12
90° Runway Splice Kit	5-12
Adjustable Junction Splice Kit	5-11
Butt Splice Kit	5-11
Cable Runway Radius Drop	5-7
Ceiling Support Bracket	5-23
Center Supports	5-25
Corner Bracket	5-14
Dividers	5-8
E-Bend	5-10
End Caps	5-20
Elevation Kits	5-17
Foot Kit	5-20
Heavy-Duty Butt Splice Kit	5-12
Hex Bolts/Screws	5-30
J-Bolt Kit	5-19
Junction Splice Kit	5-11
L-Bracket	5-21
PatchRack	5-9
Rack to Runway Mounting Plate	5-15
Support Bracket	5-18
Tall Pipe Stand	5-26
Threaded Ceiling Kit	5-25
Touch Up Paint	5-28
Vertical Floor Brackets	5-20
Wall Angle Kit	5-19
Wall to Rack Kits	5-14
Washers	5-29
D	
Dolly	2-35
Double-Sided Shelf	2-25

Description	Page #
E	
EasySwing Wall-Mount Rack	2-41
eConnect PDU, Basic	3-7
eConnect PDU, Metered	3-10
eConnect PDU, Monitored	3-12
eConnect PDU, Monitored Pro	3-16
eConnect PDU, Switched	3-21
eConnect PDU, Switched Pro	3-24
eConnect Field-Replaceable Controller	3-29
Equipment Tie-Down Bracket	2-22
Evolution Cable Manager	2-52
F	
Filler Panels	2-34
Fixed Wall-Mount Equipment Rack	2-43
G	
Global Standard Pack	2-8
Global Vertical Cabling Section	2-63
H	
Hardware Kits	2-20
Hinged Panel Mounting Bracket	2-39
I	
Industrial Enclosures (RMR)	
RMR Modular Enclosure	6-3
RMR Swing Mount Enclosure	6-12
RMR Fixed Wall-Mount Enclosure	6-15
RMR Floor-Mount Enclosure	6-20
RMR Free-Standing Enclosure	6-22
RMR Standard Wall-Mount Enclosure	6-26
RMR Accessories	
Baying Kit	6-11
Bonding Kit	6-29
Bracket for Baying Plate	6-10
Busbar Kit	6-19
Cable Lashing Bracket	6-6
Closed Loop Cooling	6-33
Dual PDU Bracket	6-7
Equipment Mounting Rails	6-16
Filter Kits, Cooling Fans	6-32
Finger Cable Manager	6-7
Front-to-Rear Lashing Bracket	6-19
LED Light Kit	6-30
Mounting Plates	6-9
Ring Cable Manager	6-8
Plinth Base	6-6
Ring Cable Manager, RMR	6-10
RMR EPDM Snap-In Grommet	6-34
Roxtec Sealing Systems, RMR	6-34
Sealing System	6-34
Swing-Out Plate Kit	6-29
XL Polyvent Kit	6-30
International Power Strips	3-35
J	
J-Bolt Kit	5-19
Junction Splice Kit	5-11

Description	Page #
L	
Lead Acid Interactive UPS	3-51
Lead Acid Online UPS	3-57
Lockable Storage Drawer	2-28
Low Profile Shelf	2-23
Lithium Standby UPS	3-49
Lithium Online UPS	3-54
M	
Mag Clips	2-73
MCS Vertical Cabling Section	2-60
Motive Cable Managers	2-48
Mounting Screws	2-39
O	
Oberon™ (Wireless)	7-3
P	
Power Management Products	
PDU/Basic eConnect	3-7
PDU/Metered eConnect	3-10
PDU/Monitored eConnect	3-12
PDU/Monitored Pro eConnect	3-16
PDU/Switched eConnect	3-21
PDU/Switched Pro eConnect	3-24
PDU Accessories	3-39
eConnect Field-Replaceable Controller	3-29
Electronic Lock Kit (RFID)	3-47
Power IQ, eConnect	3-30
Power/Remote Infrastructure Management	
Remote Infrastructure Mgmt (RIM-750)	3-45
Remote Infrastructure Mgmt (RIM-1000)	3-43
Remote Infrastructure Mgmt, Protocol Converter	3-40
Power/Uninterruptible Power Supplies (UPS)	
Lead Acid Interactive UPS	3-51
Lead Acid Online UPS	3-57
Lithium Standby UPS	3-49
Lithium Online UPS	3-54
Power/UPS Accessories	
UPS Battery Pack	3-62
UPS Bypass Distribution Modules	3-63
UPS Communications Card	3-62
UPS Isolation Transformer	3-64
UPS Mounting Bracket	3-64
UPS Rail Kit	3-64
UPS Shelf	3-64
Power Strips	3-31
Power Strips, International	3-34
Q	
QuadraRack 4-Post Frame	2-21
QuadraRack Server Frame	2-20
QuadraRack Accessories	2-20
R	
Racks (2-Post & 4-Post)	
Adjustable 4-Post Rack AQR/ASR	2-17
Adjustable Rail 4-Post Rack ARQR/ARSR	2-13
Global Standard Pack	2-8

ALPHABETICAL LISTING

Description	Page #
R	
Racks (2-Post & 4-Post)	
QuadraRack 4-Post Frame	2-21
QuadraRack Server Frame	2-20
SeismicFrame 2-Post Rack	2-11
Standard Rack, 3"	2-5
Standard Rack, 6"	2-6
Universal Rack	2-4
Velocity Standard Pack	2-9
Racks (Wall-Mount)	
EasySwing Wall-Mount Rack	2-41
Fixed Wall-Mount Equipment Rack	2-43
Heavy-Duty Wall-Mount Equipment Rack	2-40
Standard Swing Gate Wall Rack	2-42
Rack System Accessories	
Dust Covers	2-36
Equipment Guard Rail	2-36
Equipment Rails, 4-Post	2-19
Equipment Support Rack	2-37
Filler Panels	2-34
Fixed Rail	2-15
Hardware Kits, QR	2-20
Hinged Panel Mounting Bracket	2-39
Hinged Panel Mounting Bracket, Wall-Mount	2-43
Insulator Kit	2-31
Lockable Storage Drawers	2-28
Line-Up Spacer	2-22
Mounting Bar	2-39
Power Strip, Wall-Mount	2-45
Raised Floor Support Kit	2-31
Shelves	2-44
Standoffs, Rack Channel	2-38
Top-Mount Cable Waterfall Tray	2-15
Tray, Keyboard	2-30
Wall Bracket	2-40
Wall-Mount Corner Cushions	2-41
RMU Labels	2-37
RMR (Industrial Enclosures)	6-3
Rollers	2-35
S	
Seismic Systems	
SeismicFrame 2-Post Rack	2-11
SeismicFrame Cabinet System, Z4-Series	1-16
Cable Management Fingers Kit	2-12
Duplex Electrical Outlet Box	2-12
Shelves	
26" D Shelf	2-24
Extra-Heavy Sliding Shelf	2-19
Heavy-Duty Shelf	2-22
Low Profile Shelf, Racks	2-23
Monitor Shelf	2-29
Shelves, Cabinet	1-39

Description	Page #
T	
Telecommunications Enclosures (Zone)	
Basic Consolidation Enclosures	1-48
Ceiling Enclosure	1-46
Patch Panel Enclosure	1-47
Raised Floor Enclosure	1-44
Raised Floor Enclosure	1-45
Service Parts	1-49
Wiring Blocks	1-47
Tool-less Dividers	5-8
Touch Up Paint	2-34
U	
UL Listed Products*	
Adjustable Cable Runway	5-4
Aisle Containment Components	1-26
Aisle Containments, BTS Kits	1-29
Bonding/Grounding Products	4-3
Busbar	4-3
Cabinet, ZetaFrame	1-4
Cabinet, Z4-Series SeismicFrame	1-16
Cable Runway, UL Classified	5-3
Cable Runway, Universal	5-3
CUBE-IT Cabinets	1-33
eConnect PDUs	3-3
Racks, Universal	2-4
RMR Industrial Enclosures	6-3
SeismicFrame Two-Post Rack	2-11
Splice Kits	5-3
Standard Swing Gate Rack	2-42
Telecommunication, Zone Enclosures	1-45
Uninterruptible Power Supplies (UPS)	
Lead Acid Interactive UPS	3-50
Lead Acid Online UPS	3-56
Lockable Storage Drawer	2-28
Low Profile Shelf	2-23
Lithium Standby UPS	3-48
Lithium Online UPS	3-53
W	
Wireless Enclosures	
H-Plane Collection	7-5
In-Plane Collection	7-4
Netpoint Collection	7-7
Skybar Collection	7-6
Wi-Tile Collection	7-3

*UL Listed Products (identified on product pages) or visit: chatsworth.com for full product offering.



CHATSWORTH
PRODUCTS

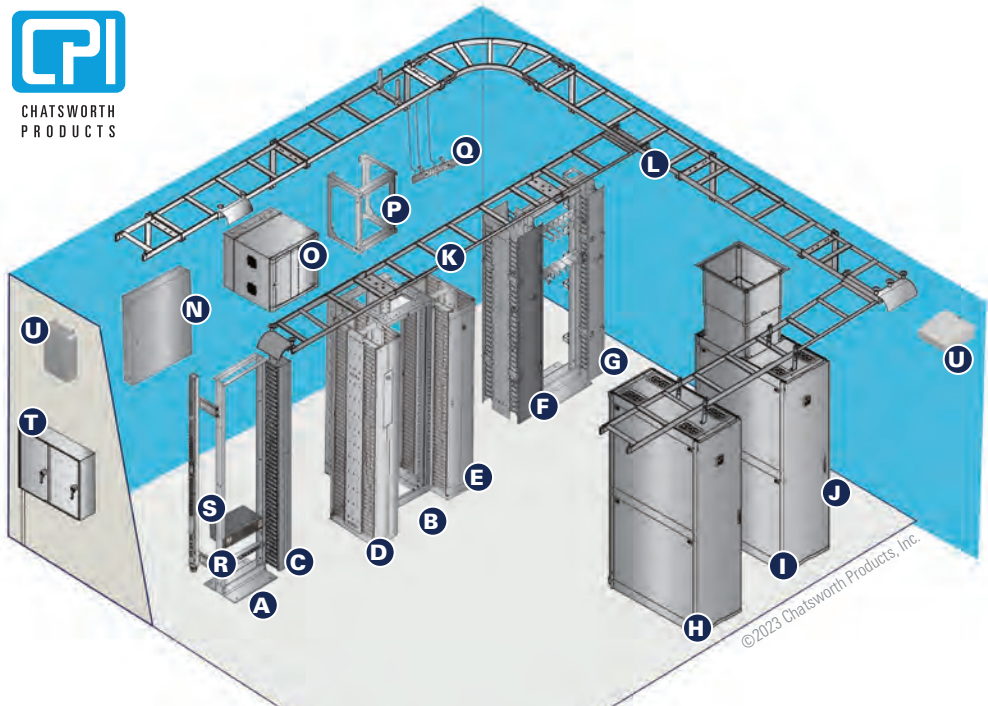

CPI Solutions Guide

Rack Systems

- A** – Two-Post Standard Rack
- B** – Adjustable Rail Server Rack

Cabinets

- H** – ZetaFrame™ Cabinet
- I** – ZetaFrame™ Cabinet with Vertical Exhaust Duct
- J** – Electronic Lock Kit

Wall-Mount Cabinets

- N** – ThinLine II Wall-Mount Cabinet
- O** – CUBE-iT® Wall-Mount Cabinet

Wall-Mount Rack

- P** – Standard Swing Gate Wall Rack

Cable Management

- C** – Velocity® Cable Management
- D** – Motive® Cable Management
- E** – Evolution® Cable Management
- F** – MCS Master Cabling Section
- G** – CCS Combination Cabling Section

Power

- R** – eConnect® PDUs
- S** – Uninterruptible Power Supply (UPS)

Bonding and Grounding

- Q** – Primary and Secondary Busbars

Cable Pathway

- K** – Adjustable Cable Runway
- L** – Universal Cable Runway

Industrial Enclosures

- T** – Industrial Enclosures
- U** – Wireless Enclosures



**CHATSWORTH
PRODUCTS**

United States & Canada
Simi Valley, CA
800-834-4969
Toronto, Ontario, Canada
+905-850-7770
chatsworth.com

Latin America
Mexico City, Mexico
+52-55-5203-7525
Toll Free within Mexico
01-800-201-7592
chatsworth.com.co

Europe
Buckinghamshire, England, UK
+44-1628-524-834
chatsworth.com

Middle East & Africa
Dubai, UAE
+971-4-2602125
Doha, Qatar
+974-4-4267422
chatsworth.com

Asia Pacific
Jing'an District, Shanghai, China
+86 21 6880-0266
chatsworth.com.cn

Find more information
about CPI solutions at:
chatsworth.com

+1-800-834-4969 (U.S. & Canada)
or techsupport@chatsworth.com

Manufacturing Capability and Global Availability

Headquartered in the United States, CPI operates from multiple sites worldwide, including offices in Mexico, Canada, China, the Middle East and the United Kingdom. CPI's manufacturing facilities are located in the United States, Canada, Asia and Europe.

Standard products are readily available through a global network of industry-leading distributors. With stock availability, and CPI's consistently short factory lead times, you can be assured that CPI solutions will be accessible to meet your project scheduling needs.

Catalog Includes

Cabinets & Containment

Racks & Cable Management

Power Monitoring & Security

Bonding & Grounding

Cable Pathway

Industrial Enclosures

Wireless Enclosures

All products quoted are subject to availability based on manufacturing capacity and shipping dates should be considered estimates only. While every effort has been made to ensure the accuracy of all information, CPI does not accept liability for any errors or omissions and reserves the right to change information and descriptions of listed services and products.

©2023 Chatsworth Products, Inc. All rights reserved. Chatsworth Products, Clik-Nut, CPI, CPI Passive Cooling, CUBE-iT, Secure Array, eConnect, Evolution, GlobalFrame, MegaFrame, QuadraRack, RMR, Saf-T-Grip, SeismicFrame, SlimFrame, TeraFrame, Motive and Velocity are federally registered trademarks of Chatsworth Products. EuroFrame, H-Plane, Hi-Bar, In-Plane, M-Frame, NetPoint, Oberon, Simply Efficient, Skybar, Wi-Tile and ZetaFrame are trademarks of Chatsworth Products. All other trademarks belong to their respective companies. Published Rev. 06/24 MKI-60020-777