

1312-00 - M-Frame Base

REVISION HISTORY				
ZONE	REV	DESCRIPTION	DATE	APPROVED
All	1	Released	2/4/2019	RLC

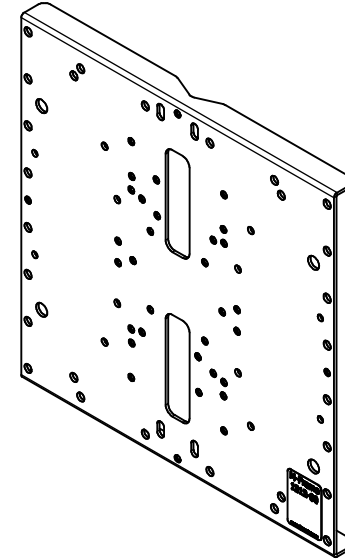

ISOMETRIC VIEW

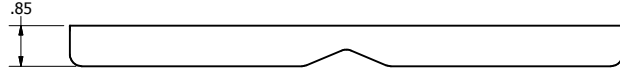
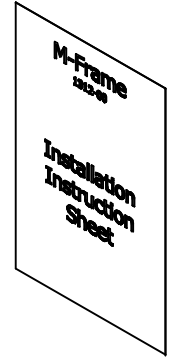
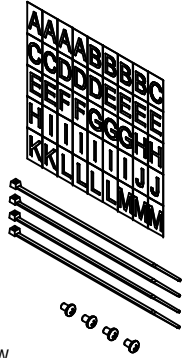

- NOTES:**
- Material: .090" Aluminum
 - Finish: Brushed
 - Mounting Holes to Match Most Manufacturers Mounting Plates
- Includes:**
- M-Frame Base
 - Mounting Screws
 - Cable Ties
 - Letter/Number Set
 - Installation Instructions

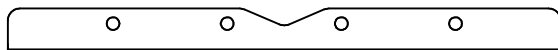
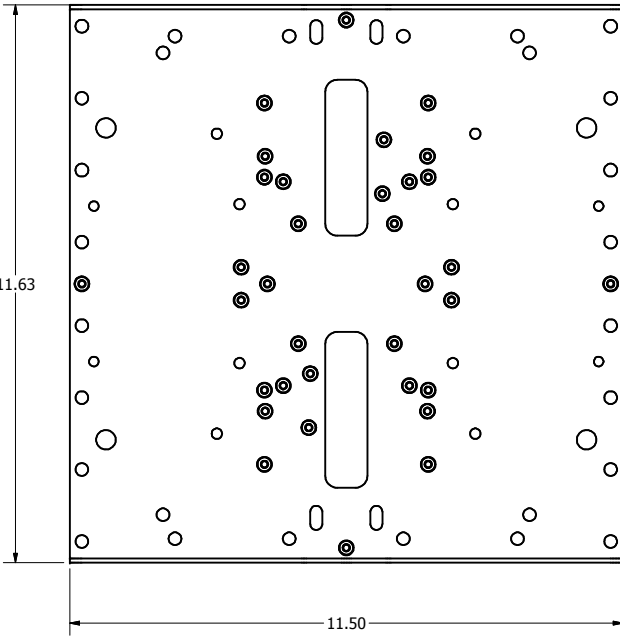

Oberon, Inc. - 1315 S. Allen St. - State College, PA 16801				
TITLE M-Frame				
SIZE C	DWG NO 1312-XXX-XXX	DATE 2/1/2019		
SCALE	SHEET 1 OF 7			

39-1312-AM1 - Omnidirectional Antenna Mounting Kit

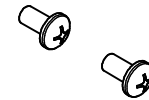
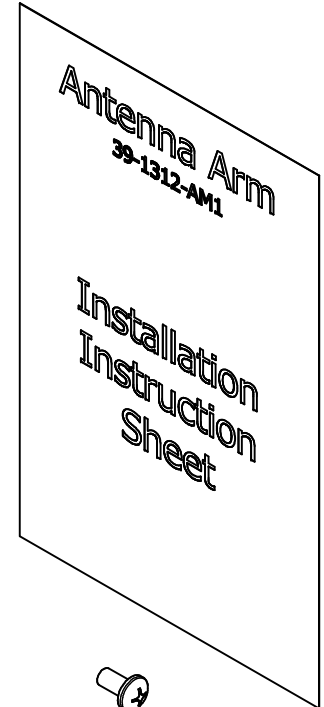
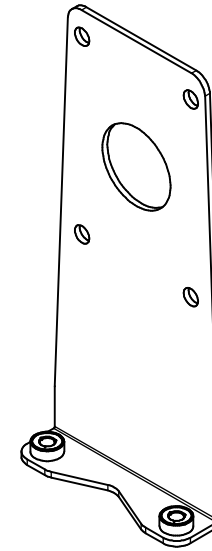
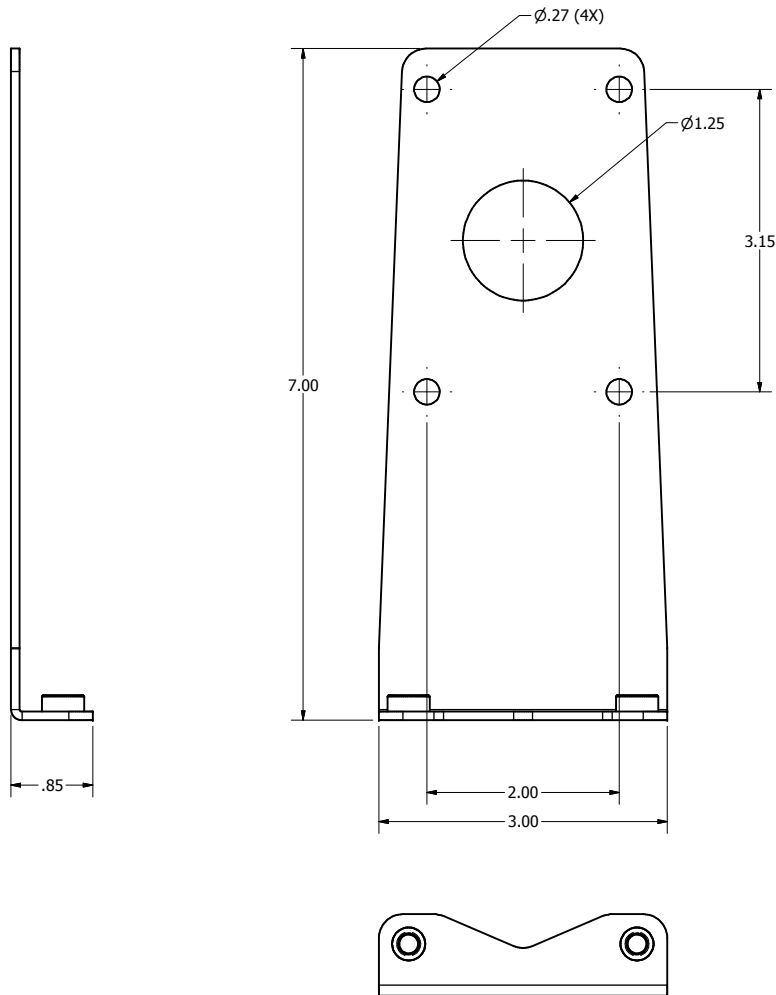

- NOTES:**
- Material: .090" Aluminum
 - Finish: Brushed
- Includes:**
- Mounting Bracket
 - Mounting Screws
 - Installation Instructions

Oberon, Inc. - 1315 S. Allen St. - State College, PA 16801		
TITLE M-Frame		
SIZE C	DWG NO 1312-XXX-XXX	DATE 2/1/2019
SCALE	SHEET 2 OF 7	

39-1312-AM2 - Omnidirectional Pipe Antenna Mounting Kit

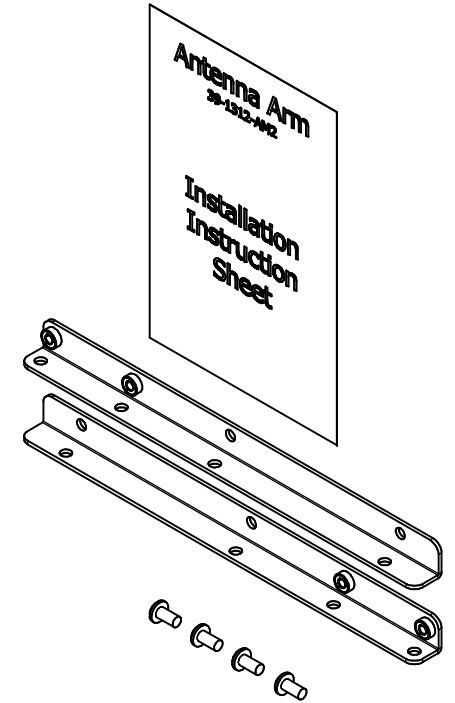
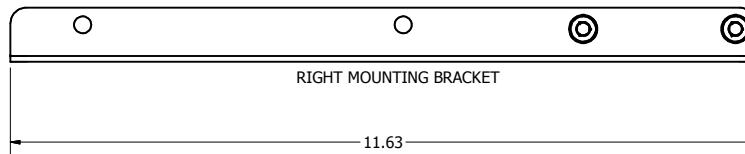
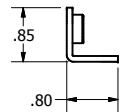
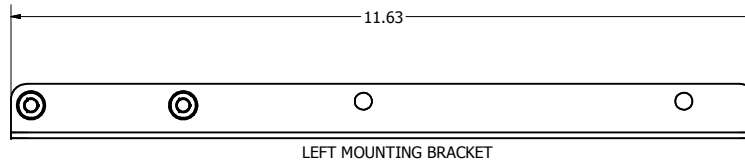
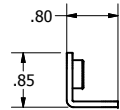

- NOTES:**
- Material: .090" Aluminum
 - Finish: Brushed
- Includes:**
- Left & Right Mounting Brackets
 - Mounting Screws
 - Installation Instructions

Oberon, Inc. - 1315 S. Allen St. - State College, PA 16801			
TITLE M-Frame			
SIZE C	DWG NO 1312-XXX-XXX	DATE 2/1/2019	
SCALE	SHEET 3 OF 7		

39-1312-AM3 - Patch Antenna Mounting Kit

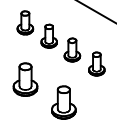
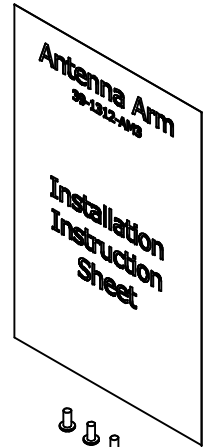
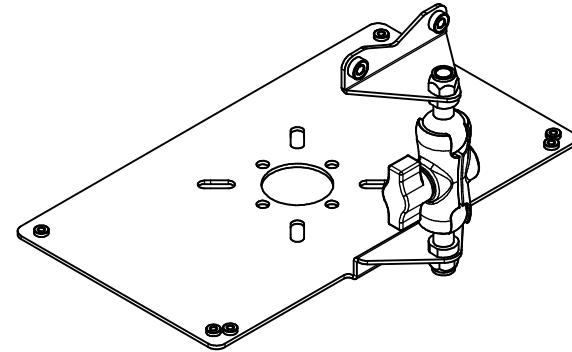
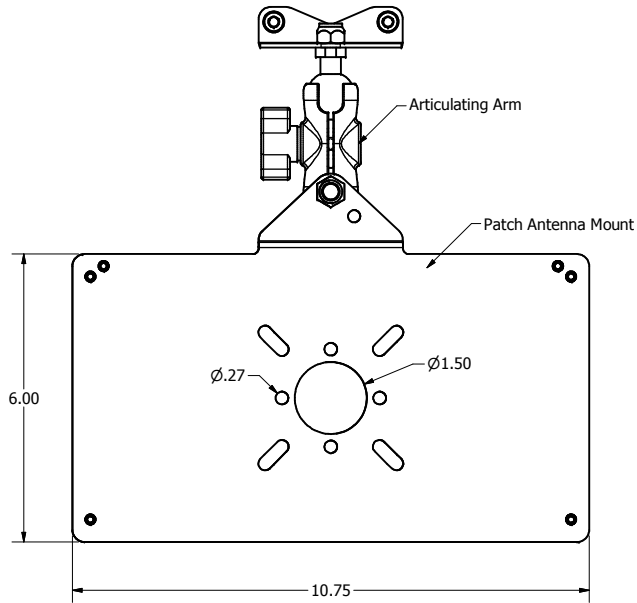
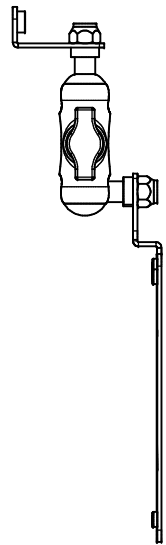

- NOTES:**
- Material: .090" Aluminum
 - Finish: Brushed
- Includes:**
- Mounting Bracket w/Articulating Arm
 - Mounting Screws
 - Installation Instructions

Oberon, Inc. - 1315 S. Allen St. - State College, PA 16801			
TITLE M-Frame			
SIZE C	DWG NO 1312-XXX-XXX	DATE 2/1/2019	
SCALE	SHEET 4 OF 7		

39-1312-RAB - Right Angle Mounting Bracket Kit

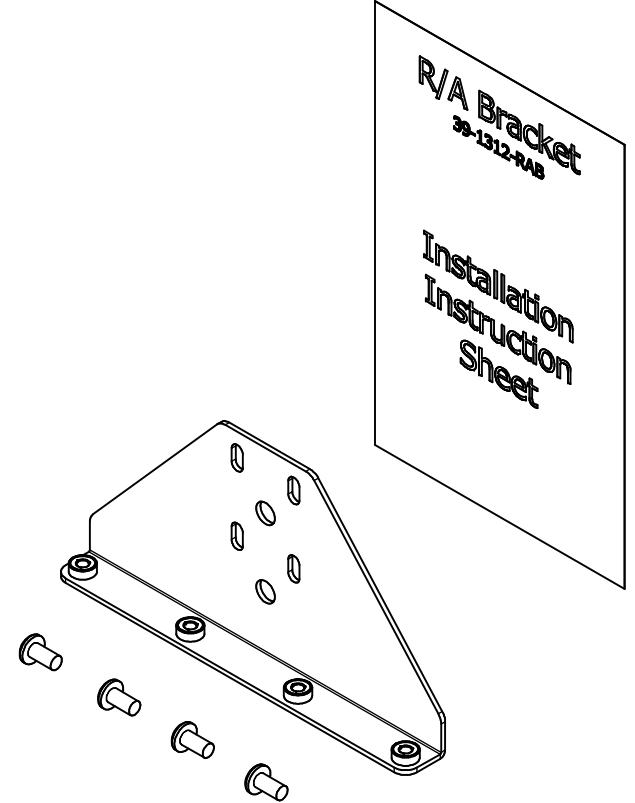
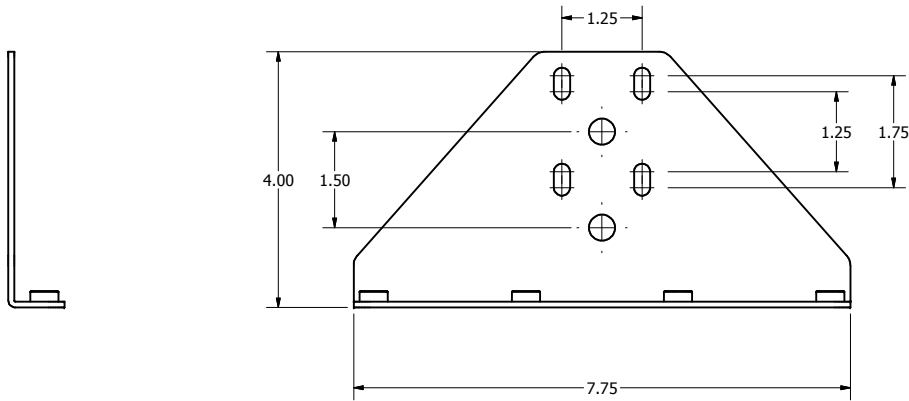

- NOTES:**
- Material: .090" Aluminum
 - Finish: Brushed
- Includes:**
- Right Angle Mounting Bracket
 - Mounting Screws
 - Installation Instructions

Oberon, Inc. - 1315 S. Allen St. - State College, PA 16801			
TITLE M-Frame			
SIZE C	DWG NO 1312-XXX-XXX	DATE 2/1/2019	
SCALE	SHEET 5 OF 7		

Hardware Kits

Column Strap
39-1312-ACS

**Installation
Instruction
Sheet**

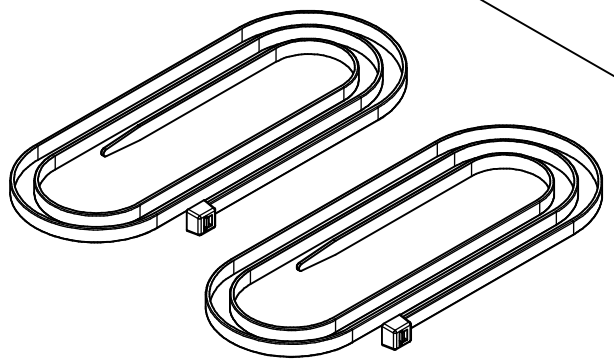

39-1312-ACS - Adjustable Column Strap Kit

Column Strap
39-1312-CWS

**Installation
Instruction
Sheet**

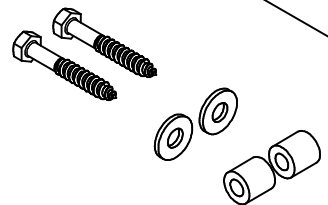

39-1312-CWS - Cement Wall Anchor Kit

Quad Hanger
39-1312-QCH

**Installation
Instruction
Sheet**

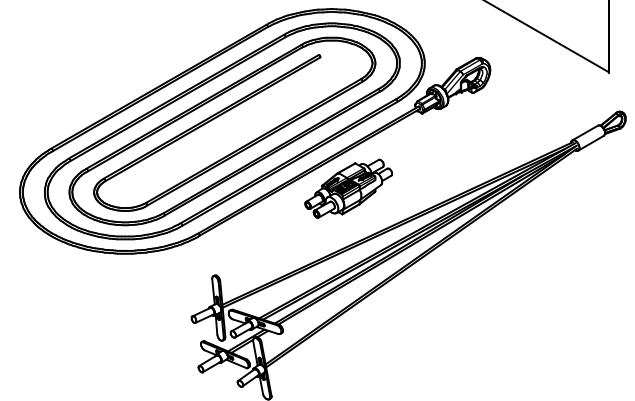

39-1312-QCH - Quad Cable Hanger Kit

Threaded Rod
39-1312-TRD

**Installation
Instruction
Sheet**

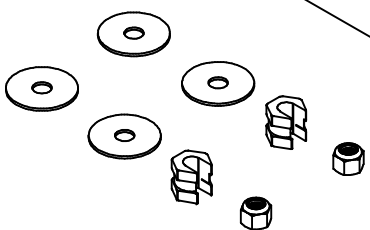

39-1312-TRD - Threaded Rod Kit

Beam Clamp
39-1312-UBC

**Installation
Instruction
Sheet**

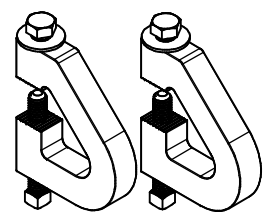

39-1312-UBC - Universal Beam Clamp Kit

Oberon, Inc. - 1315 S. Allen St. - State College, PA 16801		
TITLE		
M-Frame		
SIZE	DWG NO	DATE
C	1312-XXX-XXX	2/1/2019
SCALE	SHEET 6 OF 7	

M-Frame Model Number Look-Up Table

*NOTE - All model numbers include M-Frame base plus antenna mount / mounting option hardware kit specified below:

M-FRAME LOOK-UP TABLE		
MODEL NUMBER	ANTENNA MOUNT	MOUNTING OPTION HARDWARE KIT
1312-00-ACS	N/A	39-1312-ACS - Adjustable Column Strap Kit
1312-00-CWA	N/A	39-1312-CWS - Cement Wall Anchor Kit
1312-00-QCH	N/A	39-1312-QCH - Quad Cable Hanger Kit
1312-00-TRD	N/A	38-1312-TRD - Threaded Rod Kit
1312-00-UBC	N/A	39-1312-UBC - Universal Beam Clamp Kit
1312-AM1-ACS	39-1312-AM1 - Antenna Mount	39-1312-ACS - Adjustable Column Strap Kit
1312-AM1-CWA	39-1312-AM1 - Antenna Mount	39-1312-CWS - Cement Wall Anchor Kit
1312-AM1-QCH	39-1312-AM1 - Antenna Mount	39-1312-QCH - Quad Cable Hanger Kit
1312-AM1-TRD	39-1312-AM1 - Antenna Mount	38-1312-TRD - Threaded Rod Kit
1312-AM1-UBC	39-1312-AM1 - Antenna Mount	39-1312-UBC - Universal Beam Clamp Kit
1312-AM2-ACS	39-1312-AM2 - Antenna Mount	39-1312-ACS - Adjustable Column Strap Kit
1312-AM2-CWA	39-1312-AM2 - Antenna Mount	39-1312-CWS - Cement Wall Anchor Kit
1312-AM2-QCH	39-1312-AM2 - Antenna Mount	39-1312-QCH - Quad Cable Hanger Kit
1312-AM2-TRD	39-1312-AM2 - Antenna Mount	38-1312-TRD - Threaded Rod Kit
1312-AM2-UBC	39-1312-AM2 - Antenna Mount	39-1312-UBC - Universal Beam Clamp Kit
1312-AM3-ACS	39-1312-AM3 - Antenna Mount	39-1312-ACS - Adjustable Column Strap Kit
1312-AM3-CWA	39-1312-AM3 - Antenna Mount	39-1312-CWS - Cement Wall Anchor Kit
1312-AM3-QCH	39-1312-AM3 - Antenna Mount	39-1312-QCH - Quad Cable Hanger Kit
1312-AM3-TRD	39-1312-AM3 - Antenna Mount	38-1312-TRD - Threaded Rod Kit
1312-AM3-UBC	39-1312-AM3 - Antenna Mount	39-1312-UBC - Universal Beam Clamp Kit
MODEL NUMBER	MOUNTING OPTION	MOUNTING OPTION HARDWARE KIT
1312-RAB-ACS	39-1312-RAB - Right Angle Bracket Kit	39-1312-ACS - Adjustable Column Strap Kit
1312-RAB-CWA	39-1312-RAB - Right Angle Bracket Kit	39-1312-CWS - Cement Wall Anchor Kit
1312-RAB-UBC	39-1312-RAB - Right Angle Bracket Kit	39-1312-UBC - Universal Beam Clamp Kit

Oberon, Inc. - 1315 S. Allen St. - State College, PA 16801		
TITLE		
M-Frame		
SIZE	DWG NO	DATE
C	1312-XXX-XXX	2/1/2019
SCALE	SHEET 7 OF 7	