

User Manual for Lead Acid Online UPS

VD-Series
1000VA, 2000VA and 3000VA Models

Reference Sales Model: VDxxxxx

Version 1
April 2022



**CHATSWORTH
PRODUCTS**

800-834-4969
chatsworth.com
techsupport@chatsworth.com

While every effort has been made to ensure the accuracy of all information, CPI does not accept liability for any errors or omissions and reserves the right to change information and descriptions of listed services and products.

©2022 Chatsworth Products, Inc. All rights reserved. Chatsworth Products, CliK-Nut, CPI, CPI Passive Cooling, eConnect, Evolution, GlobalFrame, MegaFrame, Motive, QuadraRack, RMR, Saf-T-Grip, Secure Array, SeismicFrame, SlimFrame, TeraFrame and Velocity are federally registered trademarks of Chatsworth Products. CUBE-iT, EuroFrame, Simply Efficient and ZetaFrame are trademarks of Chatsworth Products. All other trademarks belong to their respective companies. 04/22 MKT-60020-767

Table of Contents

1 Safety Information	4
1.1 Transportation and Storage.....	4
1.2 Preparation.....	4
1.3 Installation.....	4
1.4 Operation.....	5
1.5 Maintenance, service and faults.....	5
2 Installation and setup	6
2.1 Rear Panel View.....	7
2.2 Operating Principle.....	8
2.3 Install the UPS.....	9
2.4 Set Up the UPS.....	9
2.5 Battery Replacement.....	13
2.6 Battery Kit Assembly.....	14
3 Operations	16
3.1 Button Operations.....	16
3.2 LCD Panel.....	16
3.3 Audible Alarm.....	18
3.4 LCD Display Index.....	18
3.5 UPS Settings.....	19
3.6 Operating Mode Descriptions.....	24
3.7 Faults Reference Code.....	25
3.8 Warning Indicator.....	25
4 Troubleshooting.....	26
4 Storage and Maintenance.....	27
5 Specifications.....	28
6 Obtaining Service.....	32
7 Limited Warranty.....	33

Introduction

User Manual for Lead Acid Online UPS

This document is the User Manual for CPI 1000VA - 3000VA Lead Acid Online Uninterruptible Power Supplies (UPS) (Sales Models VD1000A1U, VD1000A, VD1500A, VD2000A, VD3000A, VD1000B1U, VD1500B, VD2000B, VD3000B).

©2022 Chatsworth Products, Inc. All rights reserved.
UL Listed for use in U.S. and Canada.

Legal Information

The information contained in this guide is subject to change without notice. Chatsworth Products, Inc. (CPI) shall not be liable for technical or editorial errors or omissions contained herein; nor is it liable for any injury, loss, or incidental or consequential damages resulting from the furnishing, performance or use of this material and equipment.

1. Important Safety Warning

SAVE THESE INSTRUCTIONS - This manual contains important instructions that should be followed during installation and maintenance of the UPS and batteries. Please comply with all warnings and operating instructions in this manual strictly. Do not operate this unit before reading through all safety information and operating instructions carefully.

1.1 Transportation and Storage

- Please transport the UPS system only in the original package to protect against shock and impact.

1.2 Preparation

- Condensation may occur if the UPS system is moved directly from cold to warm environments. The UPS system must be absolutely dry before being installed. Please allow at least two hours for the UPS system to acclimate to the environment.
- Do not install the UPS system near water or in moist environments.
- Do not install the UPS system where it would be exposed to direct sunlight or nearby heater.
- Do not block ventilation holes in the UPS housing.

1.3 Installation

- Do not connect appliances or devices which would overload the UPS system (e.g. laser printers) to the UPS output sockets.
- Place cables in such a way that no one can step on or trip over them.
- Do not connect domestic appliances such as hair dryers to UPS output sockets.
- The UPS can be operated by any individuals with no previous experience.
- Connect the UPS system only to an earthed shockproof outlet which must be easily accessible and close to the UPS system.
- Please use cables approved by regulatory agencies (e.g. the mains cable of your computer) to connect the UPS system to the building wiring outlet (shockproof outlet).
- Please use cables approved by regulatory agencies to connect the loads to the UPS system.
- When installing the equipment, it should ensure that the sum of the leakage current of the UPS and the connected devices does not exceed 3.5mA.
- Temperature Rating - Units are considered acceptable for use in a maximum ambient of 40°C (104°F).
- For Pluggable Equipment - The socket-outlet shall be installed near the equipment and shall be easily accessible.
- **CAUTION:** The unit is heavy. Lifting the unit requires a minimum of two people.
- Batteries with minimum case flame rating V-2 are intended for use in a computer room as defined in the Standard for the Protection of Information Technology Equipment, ANSI/NFAP 75. Batteries with case flame rating HB are not intended for use in a computer room. (US installations only.)

1.4 . Operation

- Do not disconnect the mains cable on the UPS system or the building wiring outlet (shockproof socket outlet) during operations since this would cancel the protective earthing of the UPS system and of all connected loads.
- The UPS system features its own, internal current source (batteries). The UPS output sockets or output terminals block may be electrically live even if the UPS system is not connected to the building wiring outlet.
- In order to fully disconnect the UPS system, first press the OFF/Enter button to turn off the unit.

- Prevent fluids or other foreign objects from inside of the UPS system.
- The EPO and USB circuits are an IEC 60950-1 safety extra low voltage (SELV) circuit. This circuit must be separated from any hazardous voltage circuits by reinforced insulation.

1.5 Maintenance, service and faults

- The UPS system operates with hazardous voltages. Repairs may be carried out only by qualified maintenance personnel.
- **Caution** - risk of electric shock. Even after the unit is disconnected from the mains (building wiring outlet), components inside the UPS system are still connected to the battery and electrically live and dangerous.
- Before carrying out any kind of service and/or maintenance, disconnect the batteries and verify that no current is present and no hazardous voltage exists in the terminals of high capability capacitor such as BUS-capacitors.
- To avoid electrical shock, turn off the unit and unplug it from the AC power source before servicing the battery
- Only persons adequately familiar with batteries and with the required precautionary measures may replace batteries and supervise operations. Unauthorized persons must be kept well away from the batteries.
- **Caution** - risk of electric shock. The battery circuit is not isolated from the input voltage. Hazardous voltages may occur between the battery terminals and the ground. Before touching, please verify that no voltage is present!
- **Caution** - Do not dispose of batteries in a fire. The batteries may explode.
- **Caution** - Do not open or mutilate batteries. Released electrolyte is harmful to the skin and eyes. It may be toxic.
- A battery can may cause a risk of electrical shock and high short-circuit current
The following precautions should be observed when working on batteries:
 - a) Remove watches, rings, or other metal objects.
 - b) Use tools with insulated handles.
 - c) Wear rubber gloves and boots.
 - d) Do not lay tools or metal parts on top of batteries.
 - e) Disconnect charging source prior to connecting or disconnecting battery terminals.
 - f) Determine if battery is inadvertently grounded. If inadvertently grounded, remove source from ground. Contact with any part of a grounded battery can result in electrical shock. The likelihood of such shock can be reduced if such grounds are removed during installation and maintenance
- When changing batteries, install the same number and same type of batteries or battery packs.
- Please replace the fuse only with the same type and amperage in order to avoid fire hazards.
- Do not dismantle the UPS system.

1.5 Maintenance, service and faults

- **WARNING:** This is a category C2 UPS product. In a residential environment, this product may cause radio interference, in which case the user may be required to take additional measures. (only for CE models)
- **NOTE:** This equipment has been tested and found to comply with the limits for a Class A digital device, pursuant to part 15 of the FCC Rules. These limits are designed to provide reasonable protection against harmful interference when the equipment is operated in a commercial environment. This equipment generates, uses, and can radiate radio frequency energy and, if not installed and used in accordance with the instruction manual, may cause harmful interference to radio communications. Operation of this equipment in a residential area is likely to cause harmful interference in which case the user will be required to correct the interference at his own expense.
- **WARNING:** Changes or modifications not expressly approved by the party responsible for compliance could void the user's authority to operate the equipment.

2. Installation and setup

NOTE: Before installation, please inspect the unit. Be sure that nothing inside the package is damaged. Please keep the original package in a safe place for future use

2-1. Rear panel view

VDxxxxB Models:

VD1500B

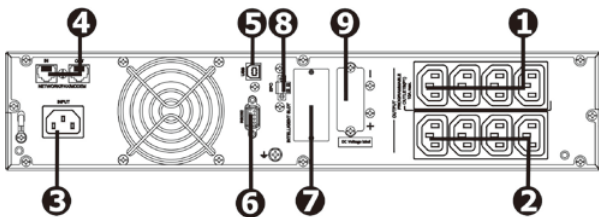

VD2000B

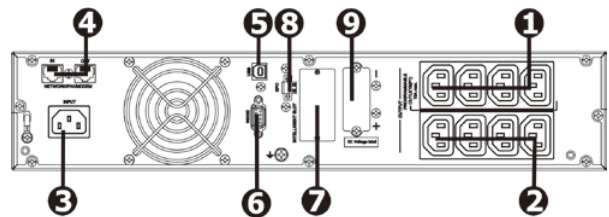

VD3000B

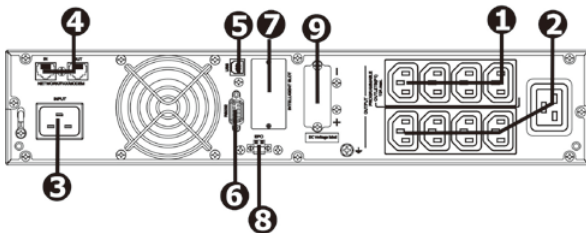

1. Programmable outlets: connect to non-critical loads.
2. Output receptacles: connect to mission-critical loads.
3. AC input
4. Network/Fax/Modem surge protection
5. USB communication port
6. RS-232 communication port
7. SNMP intelligent slot
8. Emergency power off function connector (EPO)
9. External battery connection
10. Output circuit breaker

NOTE: Before installation, please inspect the unit. Be sure that nothing inside the package is damaged. Please keep the original package in a safe place for future use

2-1. Rear panel view

VDxxxxA Models:

VD1000A/VD1500A

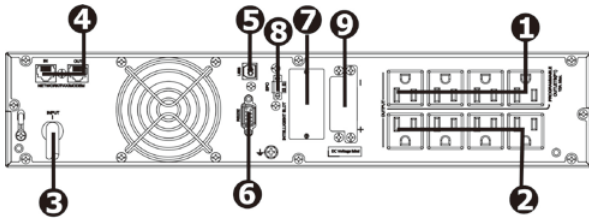

VD2000A

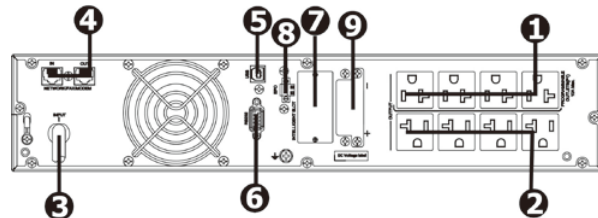

VD3000A

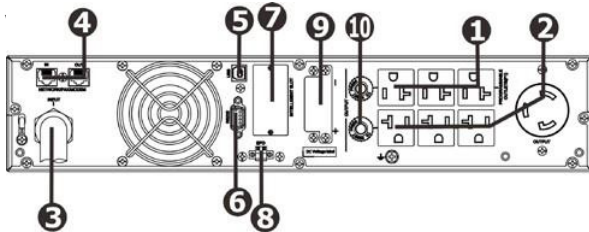

1. Programmable outlets: connect to non-critical loads.
2. Output receptacles: connect to mission-critical loads.
3. AC input
4. Network/Fax/Modem surge protection
5. USB communication port
6. RS-232 communication port
7. SNMP intelligent slot
8. Emergency power off function connector (EPO)
9. External battery connection
10. Output circuit breaker

2-2. Operating principle

The operating principle of the UPS is shown as below

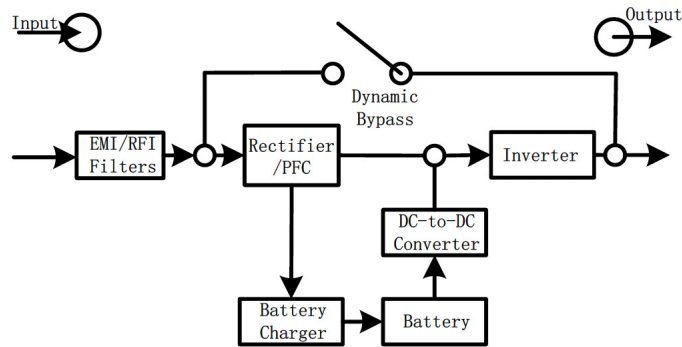

The UPS is composed of mains input, EMI/RFI filters, rectifier/PFC, inverter, battery charger, DC-to-DC converter, battery, dynamic bypass and UPS output.

2-3. Install the UPS

This UPS can be either displayed on the desk or mounted in the 19" rack chassis. Please choose proper installation to position this UPS.

Rack-Mount Installation

Step 1

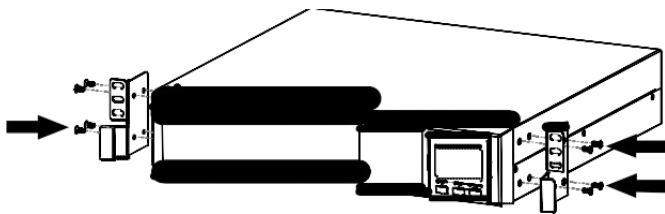

Step 2

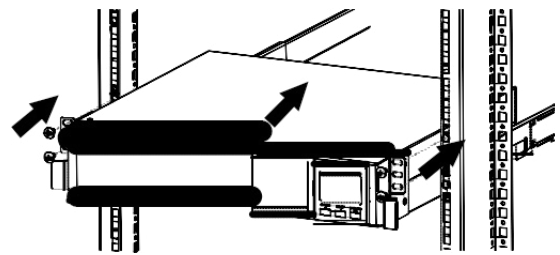

UPS Tower Installation

Step 1

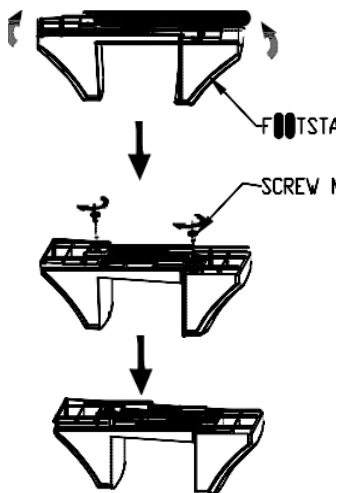

Step 2

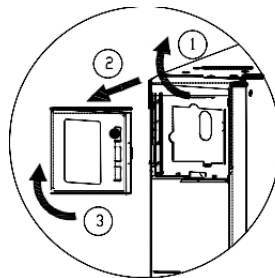

Step 3

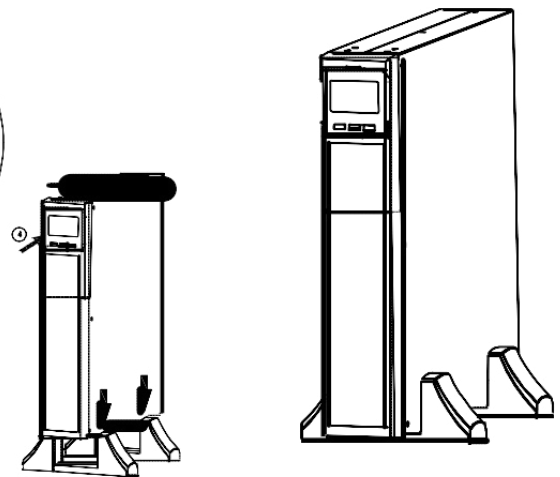

Tower Installation with Battery Pack

Step 1

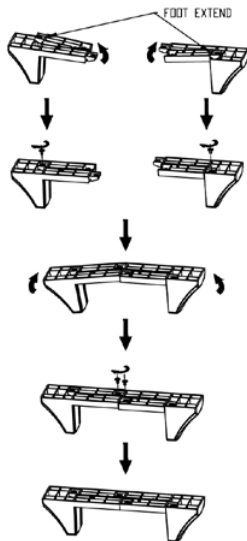

Step 2

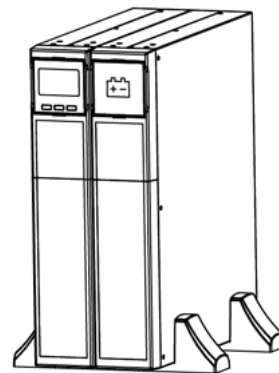

2-4. Setup the UPS

Before installing the UPS, please read below to select proper location to install UPS.

1. UPS should be placed on the flat and clean surface. Place it in an area away from vibration, dust, humidity, high temperature, flammable liquids, gas, corrosive and conductive contaminants. Install the UPS indoors in a clean environment, where it is away from window and door. Maintain minimum clearance of 4" (100mm) in the bottom of the UPS to avoid dust and high temperature.
2. Place UPS:

It's equipped with fan for cooling. Therefore, place the UPS in a well-ventilated area. It's required to maintain minimum clearance of 4" (100mm) in the front of the UPS and 12" (300mm) in the back and two sides of the UPS for heat dissipation and easy-maintenance.

Step 1: External battery connection

For safety consideration, the UPS is shipped out from factory without connecting battery wires. Before connecting to external batteries, it's required to have the internal battery wire disconnected. Follow the below steps to make external battery connection.

1. Turn off UPS and remove power plug from the mains.
2. Remove front panel and disconnect internal battery wire.

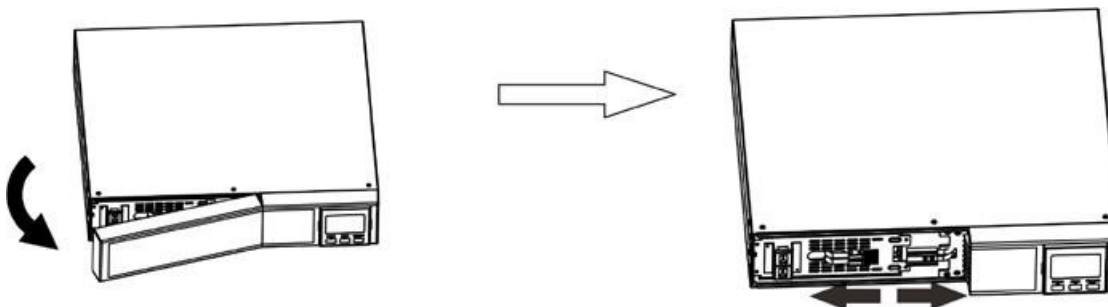

2-4. Setup the UPS

3. Remove the cover of the external battery connector by using a screwdriver.
4. Plug the battery cable into the external battery connector of the UPS and the battery pack(s).

Note: If you have multiple battery packs available, connect them serially. An example is shown in the diagram below (connecting the second battery connector of the first battery pack to the first battery connector of the second battery pack).

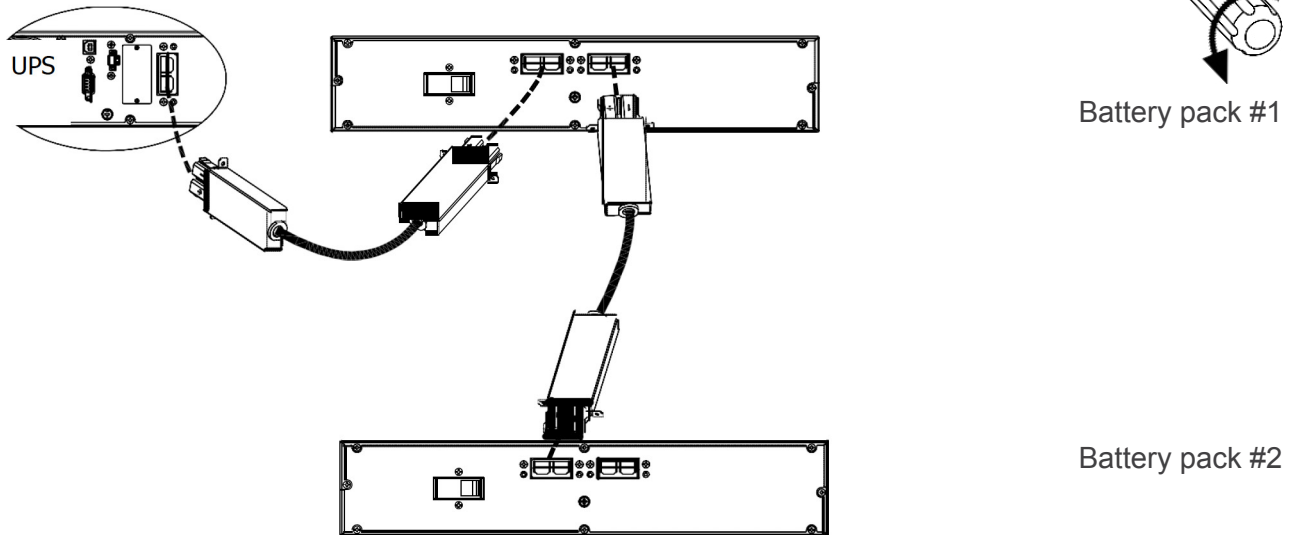

5. Stabilize the connector to the UPS and the battery pack(s) by fixing screws as shown below diagram

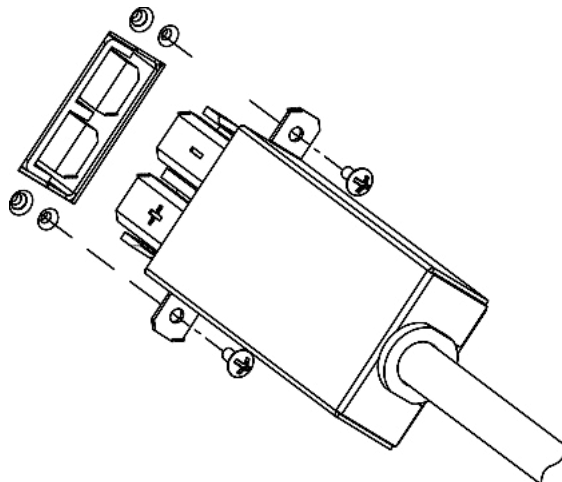

6. Connect internal battery connector and put the front panel back to the unit.

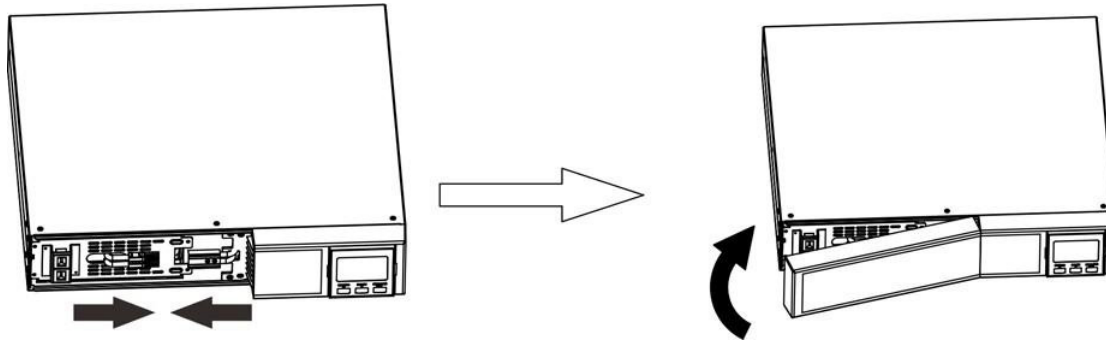

Step 2: UPS input connection

Plug the UPS into a two-pole, three-wire, grounded receptacle only. Avoid using extension cords.

- For VDxxxxB models: The power cord is supplied in the UPS package.
- For VDxxxxA models: The power cord is attached to the UPS. The input plug is a NEMA 5-15P for VD1500A and VD2000A models, NEMA 5-20P for 2000 model and NEMA L5-30P for VD3000A model.

To reduce the risk of fire, connect only to a circuit provided with (@) a maximum branch circuit overcurrent protection in accordance with the National Electrical Code, ANSI/NFPA 70 and the Canadian Electrical Code, Part I, C22.1.

MODEL	(@)
VD1000X	20A
VD1500X	20A
VD2000X	20A
VD3000X	40A

Step 3: UPS output connection

There are two kinds of outputs: programmable outlets and general outlets. Please connect non-critical devices to the programmable outlets and critical devices to the general outlets. During power failure, you may extend the backup time to critical devices by setting shorter backup time for non-critical devices.

Step 4: Communication connection

Communication ports:

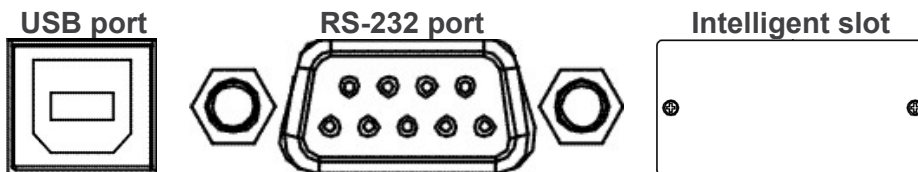

To allow for unattended UPS shutdown/start-up and status monitoring, connect the communication cable one end to the USB/RS-232 port and the other to the communication port of your PC. With the monitoring software installed, you can schedule UPS shutdown/start-up and monitor UPS status through PC.

The UPS is equipped with intelligent slot perfect for either SNMP or Dry Contact/Relay card. When installing either SNMP or Dry Contact/Relay card in the UPS, it will provide advanced communication and monitoring options.

Step 5: Network connection

Network/Fax/Phone surge port

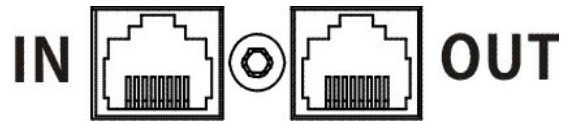

Connect a single modem/phone/fax line into surge-protected “IN” outlet on the back panel of the UPS unit. Connect from “OUT” outlet to the equipment with another modem/fax/phone line cable.

Step 6: Disable and enable EPO function

This UPS is equipped with EPO function. By default, the UPS is delivered from factory with Pin 1 and pin 2 closed (a metal plate is connected to Pin 1 and Pin2) for UPS normal operation. To activate EPO function, remove two screws on EPO port and metal plate will be removed.

Note: The EPO function logic can be set up via LCD setting. Please refer to program 16 in UPS setting for the details.

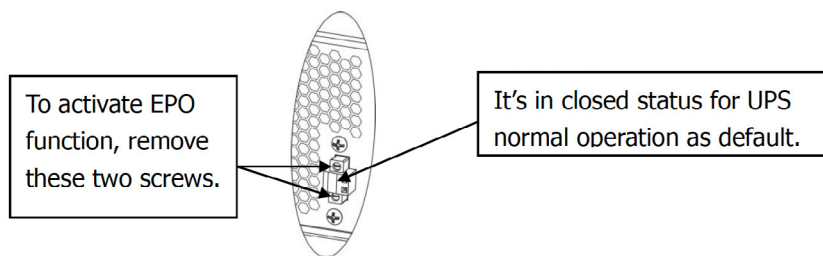
**Step 7: Turn on the UPS**

Press the ON/Mute button on the front panel for two seconds to power on the UPS.



Note: The battery charges fully during the first five hours of normal operation. Do not expect full battery run capability during this initial charge period.

Step 8: Install software

For optimal computer system protection, install UPS monitoring software to fully configure UPS shutdown. Use supplied RS-232 or USB communication cable to connect RS-232/USB port of UPS and RS-232/USB port of PC. Then, follow below steps to install monitoring software.

1. Insert the included installation CD into CD-ROM drive and then follow the on-screen instructions to proceed software installation. If there no screen shows 1 minute after inserting the CD, please execute setup.exe file for initiating software installation.
2. Follow the on-screen instructions to install the software.
3. When your computer restarts, the monitoring software will appear as an orange plug icon located in the system tray, near the clock.

2-5. Battery Replacement

When the icons of  and  are flashing in LCD display and alarm is sounding every 2 seconds, it's time to replace batteries. Contact your service representative to replace batteries.

Do not disconnect battery connectors under load. If you prefer to remove input power to change the batteries, press the OFF button on the front panel for two seconds to power off the UPS and switch off utility power where the UPS is connected.

NOTE 1: DO NOT DISCONNECT the batteries while the UPS is in Battery mode.

NOTE 2: A small amount of arcing may occur when connecting the internal batteries. This is normal condition and no harm for personnel. Connect the cables quickly and firmly.

NOTE 3: This UPS is equipped with internal batteries and only service person can replace the batteries.

NOTE 4: Upon battery disconnection, equipment is not protected from power outages.

CAUTION!! Consider all warnings, cautions, and notes before replacing batteries.

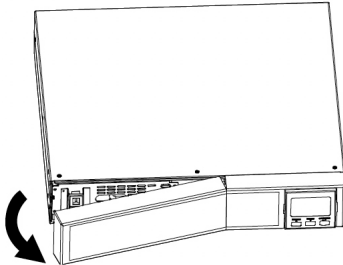

Step 1 Remove front panel.

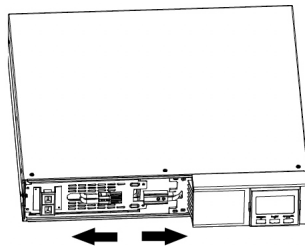

Step 2 Disconnect battery wires.

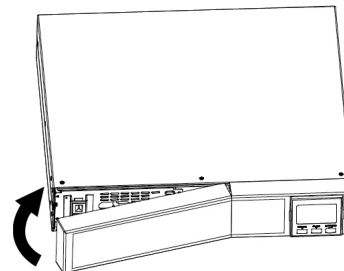

Step 3 Pull out the battery box by removing two screws on the front panel.

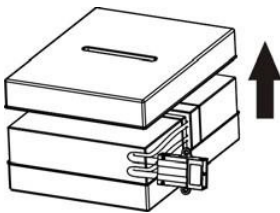

Step 4 Remove the top cover of battery box and replace the inside batteries.

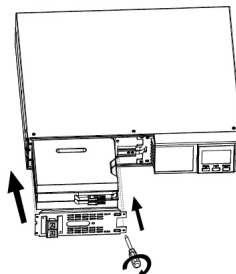

Step 5 After replacing the batteries, put the battery box back to original location and screw it tightly.

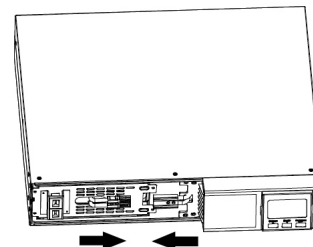

Step 6 Re-connect the battery wires.

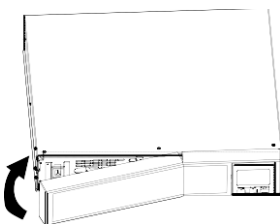

Step 7 Put the front panel back to the unit.

2-6. Battery Kit Assembly

NOTICE: Please assemble battery kit first before installing it inside of UPS. Please select correct battery kit procedure below to assemble it.

2-Battery Kit

Step 1 Remove adhesive tapes.

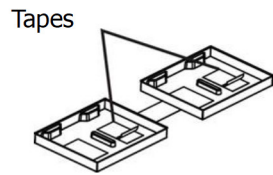

Step 3 Put assembled battery packs on one side of plastic shells.

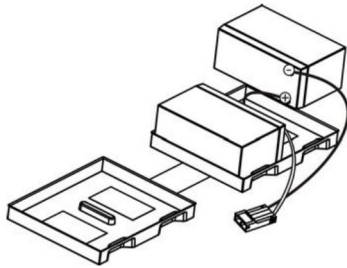

Step 2 Connect all battery terminals by following below chart

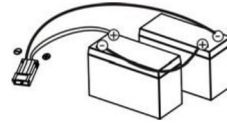

Step 4 Cover the other side of plastic shell as below chart. Then, battery kit is assembled.

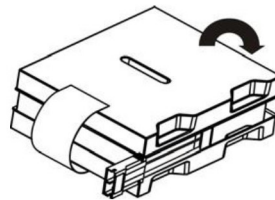

3-Battery Kit

Step 1 Remove adhesive tapes.

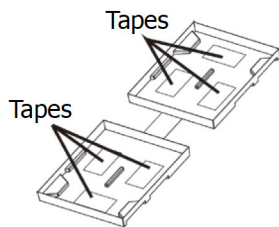

Step 3 Put assembled battery packs on one side of plastic shells.

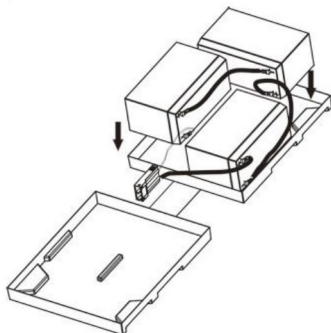

Step 2 Connect all battery terminals by following below chart

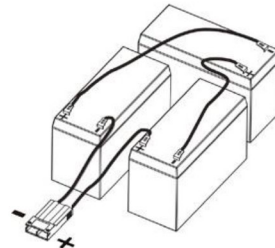

Step 4 Cover the other side of plastic shell as below chart. Then, battery kit is assembled.

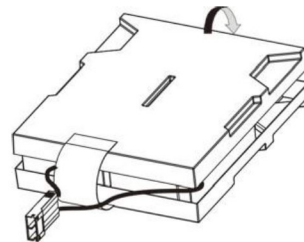

4-Battery Kit

Step 1 Remove adhesive tapes.

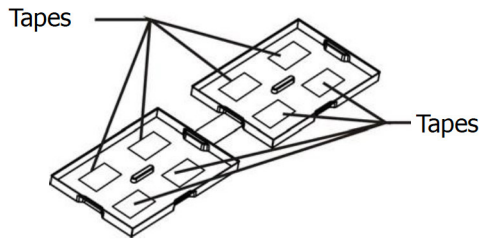

Step 2 Connect all battery terminals by following below chart

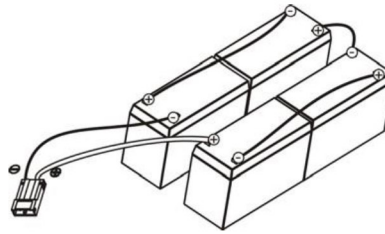

Step 3 Put assembled battery packs on one side of plastic shells.

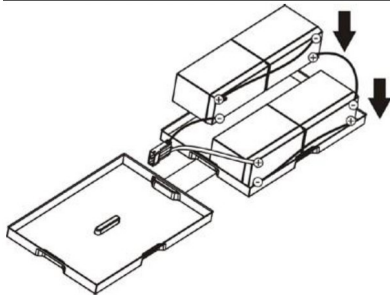

Step 4 Cover the other side of plastic shell as below chart. Then, battery kit is assembled.

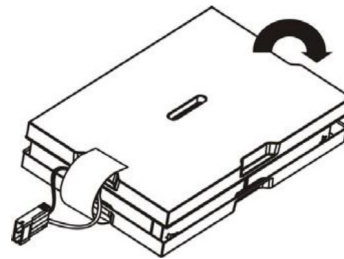

6-Battery Kit

Step 1 Remove adhesive tapes.

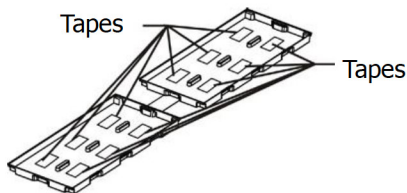

Step 2 Connect all battery terminals by following below chart

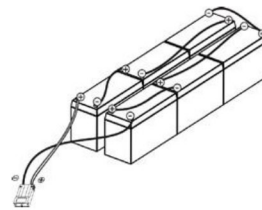

Step 3 Put assembled battery packs on one side of plastic shells.

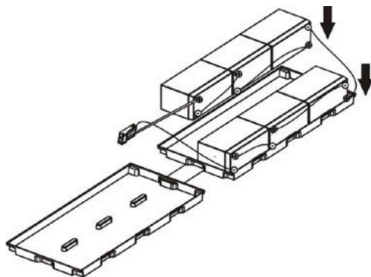

Step 4 Cover the other side of plastic shell as below chart. Then, battery kit is assembled.

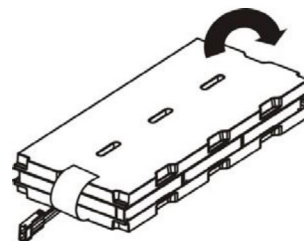









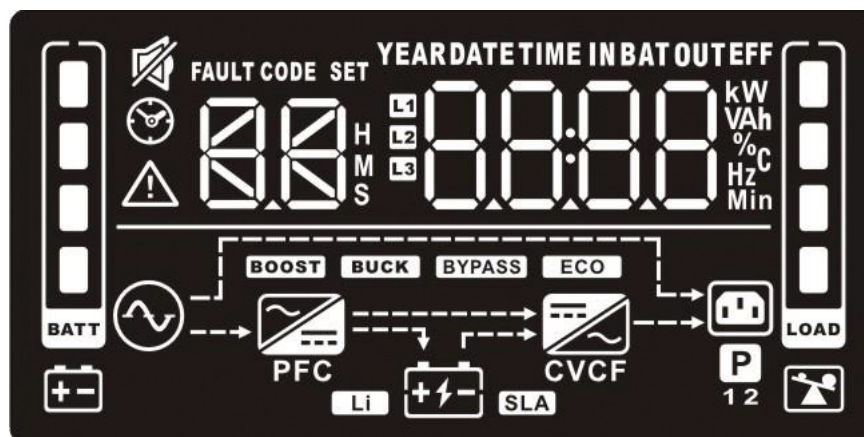



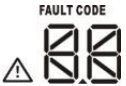





3. Operations

3-1. Button Operation

Button	Function
ON/MUTE Button	<ul style="list-style-type: none"> Turn on the UPS: Press and hold ON/Mute button for at least 2 seconds to turn on the UPS. Mute the alarm: After the UPS is turned on in battery mode, press and hold this button for at least 3 seconds to disable or enable the alarm system. But it's not applied to the situations when warnings or errors occur. Up key: Press this button to display previous selection in UPS setting mode. Switch to UPS self-test mode: Press and hold ON/Mute button for 3 seconds to enter UPS self-testing while in AC mode
OFF/ENTER Button	<ul style="list-style-type: none"> Turn off the UPS: Press and hold this button at least 2 seconds to turn off the UPS. UPS will be in standby mode under power normal or transfer to Bypass mode if the Bypass enable setting is set by pressing this button. Confirm selection key: Press this button to confirm selection in UPS setting mode.
SELECT Button	<ul style="list-style-type: none"> Switch LCD message: Press this button to change the LCD message for input voltage, input frequency, input current, battery voltage, battery current, battery capacity, ambient temperature, output voltage, output frequency, load current and load percent. Setting mode: Press and hold this button for 3 seconds to enter UPS setting mode when Standby and Bypass mode. Down key: Press this button to display next selection in UPS setting mode.
ON/Mute + Select Button	<ul style="list-style-type: none"> Switch to bypass mode: When the main power is normal, press ON/Mute and Select buttons simultaneously for 3 seconds. Then UPS will enter to bypass mode. This action will be ineffective when the input voltage is out of acceptable range Exit setting mode or return to the upper menu: When working in setting mode, press ON/Mute and Select buttons simultaneously for 0.2 seconds to return to the upper menu. If it's already in top menu, press these two buttons at the same time to exit the setting mode.

3-2. LCD Panel



Display	Function
Backup time information	
	Indicates the estimated backup time. H: hours, M: minute, S: second.
Configuration and fault information	
	Indicates the configuration items, and the configuration items are listed in details in section 3-5.
	Indicates the warning and fault codes, and the codes are listed in details in section 3-7 and 3-8.
Mute operation	
	Indicates that the UPS alarm is disabled.
Input, Battery, Temperature, Output & Load information	
	Indicates the input voltage, input frequency, input current, battery voltage, battery current, battery capacity, ambient temperature, output voltage, output frequency, load current and load percent. k: kilo, W: watt, V: voltage, A: ampere, %: percent, "C": centigrade degree, Hz: frequency
Load information	
	Indicates the load level by 0-24%, 25-49%, 50-74% and 75-100%.
	Indicates overload.
Programmable outlets information	
	Indicates that programmable management outlets are working.
Mode operation information	
	Indicates the UPS connects to the mains.
	Indicates the battery is working.
	Indicates charging status
	Indicates the bypass circuit is working.
	Indicates the ECO mode is enabled.
	Indicates the AC to DC circuit is working.
	Indicates the PFC circuit is working.
	Indicates the inverter circuit is working.
	Indicates the UPS is working in converter mode.
Battery information	
	Indicates the battery level by 0-24%, 25-49%, 50-74%, and 75-100%
	Indicates low battery.

3-3. Audible Alarm

Battery Mode	Sounding every 5 seconds
Low Battery	Sounding every 2 seconds
Overload	Sounding every second
Fault	Continuously sounding
Bypass Mode	Sounding every 10 seconds

3-4. LCD display wordings index

Abbreviation	Display content	Meaning
ENA	ENa	Enable
DIS	dI S	Disable
ESC	ESC	Escape
HLS	HLS	High loss
LLS	LLS	Low loss
AO	AO	Active open
AC	AC	Active close
EAT	EAt	Estimated autonomy time
RAT	rAt	Running autonomy time
SD	Sd	Shutdown
OK	OK	OK
ON	ON	ON
BL	bL	Battery Low
OL	OL	Over Load
OI	OI	Over input current
NC	nC	Battery No Connect
OC	OC	Over Charge
SF	SF	Site wiring fault
EP	EP	EPO
TP	tP	Temperature
CH	CH	Charger
BF	bF	Battery Fault
BV	bV	Bypass Out Range
FU	FU	Bypass frequency unstable
BR	bR	Battery Replace
EE	EE	EEPROM error

3-5. UPS Setting

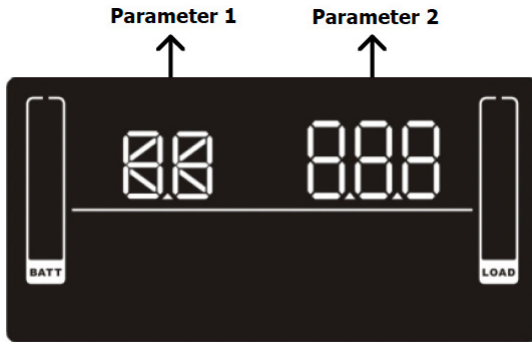

There are three parameters to set up the UPS. Parameter 1: It's for program alternatives. Refer to below table. Parameter 2 is the setting options or values for each program.

• 01: Output voltage setting

Interface	Settings
	<p>Parameter 2: Output voltage For 230 Models, You may choose the following output voltage: 200: presents output voltage is 200Vac 208: presents output voltage is 208Vac 220: presents output voltage is 220Vac 230: presents output voltage is 230Vac (Default) 240: presents output voltage is 240Vac For 120 Models, You may choose the following output voltage: 100: presents output voltage is 100Vac 110: presents output voltage is 110Vac 115: presents output voltage is 115Vac 120: presents output voltage is 120Vac (Default) 125: presents output voltage is 125Vac</p>

• 02: Frequency Converter enable/disable

Interface	Settings
	<p>Parameter 2: Enable or disable converter mode. You may choose the following two options: CF ENA: converter mode enable CF DIS: converter mode disable (Default)</p>

• 03: Output frequency setting

Interface	Settings
	<p>Parameter 2: Output frequency setting. You may set the initial frequency on battery mode: BAT 50: presents output frequency is 50Hz BAT 60: presents output frequency is 60Hz If converter mode is enabled, you may choose the following output frequency: CF 50: presents output frequency is 50Hz CF 60: presents output frequency is 60Hz</p>

Interface	Settings
 <p>The LCD display shows '04' on the left and 'd15' on the right. Above '04' is the word 'SET'. Below 'd15' is the word 'ECO'. On the far left and right are vertical bars labeled 'BATT' and 'LOAD' respectively.</p>	<p>Parameter 2: Enable or disable ECO function. You may choose the following two options: mode enable</p> <p>ENA: ECO mode enable</p> <p>DIS: ECO mode disable (Default)</p>

• 05: ECO voltage range setting

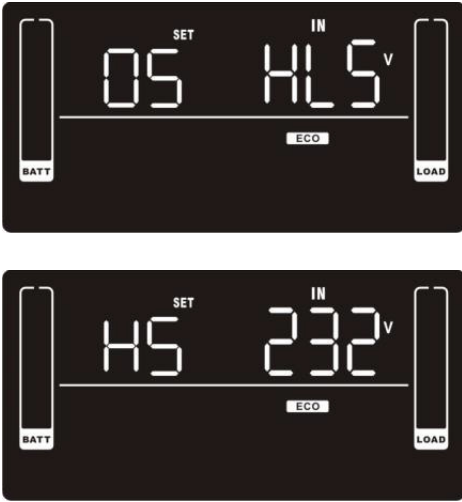
Interface	Settings
 <p>The top LCD display shows '05' on the left and 'IN' on the right. Above '05' is 'SET'. Below 'IN' is 'HLS' followed by a 'V' symbol. Below 'HLS' is the word 'ECO'. On the far left and right are vertical bars labeled 'BATT' and 'LOAD' respectively.</p> <p>The bottom LCD display shows 'H5' on the left and '232' on the right. Above 'H5' is 'SET'. Above '232' is 'IN' followed by a 'V' symbol. Below '232' is the word 'ECO'. On the far left and right are vertical bars labeled 'BATT' and 'LOAD' respectively.</p>	<p>Parameter 2: Set the acceptable high voltage point and low voltage point for ECO mode by pressing Down key or Up key.</p> <p>HLS: High loss voltage in ECO mode in parameter 2. For 230 Models, the setting range in parameter 3 is from +7V to +24V of the nominal voltage. (Default: +12V) For 120 Models, the setting range in parameter 3 is from +3V to +12V of the nominal voltage. (Default: +6V)</p> <p>LLS: Low loss voltage in ECO mode in parameter 2. For 230 Models, the setting range in parameter 3 is from -7V to -24V of the nominal voltage. (Default: -12V) For 120 Models, the setting voltage in parameter 3 is from -3V to -12V of the nominal voltage. (Default: -6V)</p>

• 06: Bypass enable/disable when UPS is off

Interface	Settings
 <p>The LCD display shows '06' on the left and 'd15' on the right. Above '06' is the word 'SET'. Below 'd15' is the word 'BYPASS'. On the far left and right are vertical bars labeled 'BATT' and 'LOAD' respectively.</p>	<p>Parameter 2: Enable or disable Bypass function. You may choose the following two options:</p> <p>ENA: Bypass enable</p> <p>DIS: Bypass disable (Default)</p>

• 07: Bypass voltage range setting

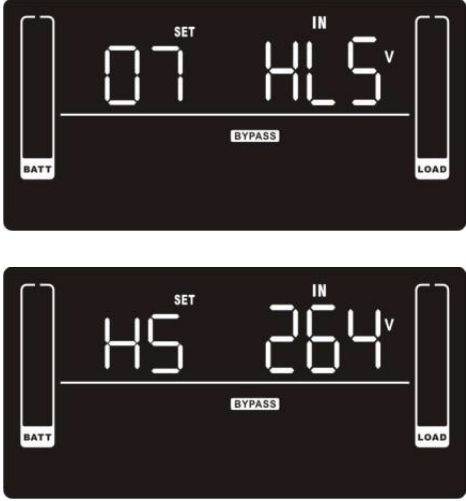
Interface	Settings
	<p>Parameter 2: Set the acceptable high voltage point and acceptable low voltage point for Bypass mode by pressing the Down key or Up key.</p> <p>HLS: Bypass high voltage point For 230 Models: 230-264: setting the high voltage point in parameter 3 from 230Vac to 264Vac. (Default: 264Vac) For 120 Models: 120-140: setting the high voltage point in parameter 3 from 120Vac to 140Vac. (Default: 132Vac)</p> <p>LLS: Bypass low voltage point For 230 Models: 170-220: setting the low voltage point in parameter 3 from 170Vac to 220Vac. (Default: 170Vac) For 120 Models: 85-115: setting the low voltage point in parameter 3 from 85Vac to 115Vac. (Default: 85Vac)</p>

• 08: Bypass frequency range setting

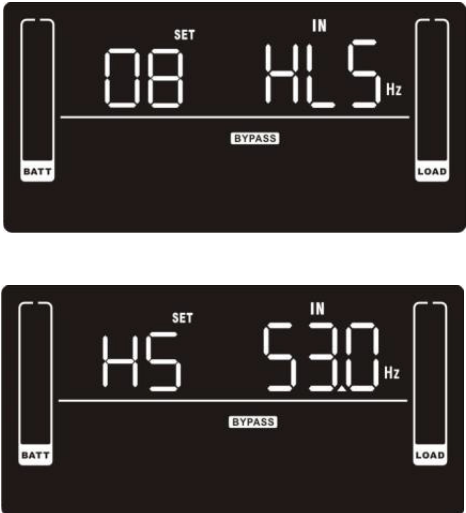
Interface	Settings
	<p>Parameter 2: Set the acceptable high frequency point and acceptable low frequency point for Bypass mode by pressing the Down key or Up key.</p> <p>HLS: Bypass high frequency point For 50Hz output frequency models: 51-55Hz: setting the frequency high loss point from 51Hz to 55Hz(Default: 53.0Hz) For 60Hz output frequency models: 61-65Hz: setting the frequency high loss point from 61Hz to 65Hz(Default: 63.0Hz)</p> <p>LLS: Bypass low Frequency point For 50Hz output frequency models: 45-49Hz: setting the frequency low loss point from 45Hz to 49Hz(Default: 47.0Hz) For 60Hz output frequency models: 55-59Hz: setting the frequency low loss point from 55Hz to 59Hz(Default: 57.0Hz)</p>

• 09 : Programmable outlets enable/disable

Interface	Settings
	<p>Parameter 2: Enable or disable programmable outlets.</p> <p>ENA: Programmable outlets enable DIS: Programmable outlets disable (Default)</p>

• 10 : Programmable outlets setting

Interface	Settings
 <p>The interface shows a digital display with '10 M' on the left and '999' on the right. Above the numbers is the word 'SET'. Below the display are 'BATT' and 'LOAD' indicators, and a small 'P' icon.</p>	<p>Parameter 2: Set up backup time limits for programmable outlets. 0-999: setting the backup time limits in minutes from 0-999 for programmable outlets which connect to non-critical devices on battery mode. (Default: 999)</p>

• 11: Autonomy limitation setting

Interface	Settings
 <p>The interface shows a digital display with '11 M' on the left and '999' on the right. Above the numbers is the word 'SET'. Below the display are 'BATT' and 'LOAD' indicators, and a battery icon.</p>	<p>Parameter 2: Set up backup time on battery mode for general outlets. 0-999: setting the backup time in minutes from 0-999 for general outlets on battery mode. DIS: Disable the autonomy limitation and the backup time will depend on battery capacity. (Default) Note: When setting as "0", the backup time will be only 10 seconds.</p>

• 12: Battery total AH setting

Interface	Settings
 <p>The interface shows a digital display with '12' on the left and '7 Ah' on the right. Above the numbers is the word 'SET'. Below the display are 'BATT' and 'LOAD' indicators.</p>	<p>Parameter 2: Set up the battery total AH of the UPS. 7-999: setting the battery total capacity from 7-999 in AH. Please set the correct battery total capacity if external battery bank is connected.</p>

• 13 : Maximum charger current setting

Interface	Settings										
 <p>The interface shows a digital display with '13' on the left and '8 A' on the right. Above the numbers is the word 'SET'. Below the display are 'BATT' and 'LOAD' indicators, and a battery icon.</p>	<p>Parameter 2: Set up the charger maximum current. 1/2/4/6/8: setting the charger maximum current 1/2/4/6/8 in Ampere. (Default: 4A) Recharge time VS charging current is as below table.</p> <table border="1" data-bbox="716 1724 1386 1929"> <thead> <tr> <th>Battery capacity(AH)</th> <th>Total charging current (A)</th> </tr> </thead> <tbody> <tr> <td>7~20</td> <td>2</td> </tr> <tr> <td>20~40</td> <td>4</td> </tr> <tr> <td>40~60</td> <td>6</td> </tr> <tr> <td>60~</td> <td>8</td> </tr> </tbody> </table>	Battery capacity(AH)	Total charging current (A)	7~20	2	20~40	4	40~60	6	60~	8
Battery capacity(AH)	Total charging current (A)										
7~20	2										
20~40	4										
40~60	6										
60~	8										

- 14: Charger boost voltage setting

Interface	Settings
	<p>Parameter 2: Set up the charger boost voltage. 2.25-2.40: setting the charger boost voltage from 2.25 V/cell to 2.40V/cell. (Default: 2.36V/cell)</p>

- 15: Charger float voltage setting

Interface	Settings
	<p>Parameter 2: Set up the charger float voltage. 2.20-2.33: setting the charger float voltage from 2.20 V/cell to 2.33V/cell. (Default: 2.28V/cell)</p>

- 16: EPO logic setting

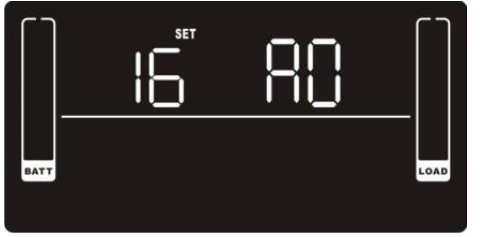
Interface	Settings
	<p>Parameter 2: Set up the EPO function control logic. AO: Active Open (Default). When AO is selected as EPO logic, it will activate EPO function with Pin 1 and Pin 2 in open status. AC: Active Close. When AC is selected as EPO logic, it will activate EPO function with Pin 1 and Pin 2 in close status.</p>

- 16: EPO logic setting

Interface	Settings
	<p>Parameter 2: Set up the EPO function control logic. AO: Active Open (Default). When AO is selected as EPO logic, it will activate EPO function with Pin 1 and Pin 2 in open status. AC: Active Close. When AC is selected as EPO logic, it will activate EPO function with Pin 1 and Pin 2 in close status.</p>

- 17: Site fault detection enable/disable

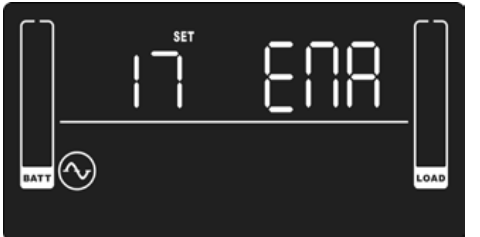
Interface	Settings
	<p>Parameter 2: Enable or disable site fault detection. You may choose the following two options: ENA: Site fault detection enable (Default for VDxxxxB models) DIS: Site fault detection disable (Default for VDxxxxA models)</p>







• 18: Display setting for autonomy time

Interface	Settings
	<p>Parameter 2: Set up the display setting for autonomy time EAT: If EAT is selected, it will display the remaining autonomy time. (Default) RAT: If RAT is selected, it will show accumulated autonomy time so far.</p>

• 00: Exit setting

Interface	Settings
	Exit the setting mode.















3-6. Operating Mode Description

Operating mode	Description	LCD display
Online mode	When the input voltage is within acceptable range, UPS will provide pure and stable AC power to output. The UPS will also charge the battery at online mode. .	
ECO mode	Energy saving mode: When the input voltage is within voltage regulation range, UPS will bypass voltage to output for energy saving. The UPS will also charge the battery at ECO mode.	
Frequency Converter mode	When input frequency is within 40 Hz to 70 Hz, the UPS can be set at a constant output frequency, 50 Hz or 60 Hz. The UPS will still charge battery under this mode.	
Battery mode	When the input voltage is beyond the acceptable range or power failure, the UPS will backup power from battery and alarm is sounding every 5 seconds. .	
Bypass mode	When input voltage is within acceptable range but UPS is overload, UPS will enter bypass mode or bypass mode can be set by front panel. Alarm is sounding every 10 seconds.	
Standby mode	UPS is powered off and no output supply power, but still can charge batteries.	
Fault mode	When a fault has occurred, the ERROR icon and the fault code will be displayed.	

3-7. Faults Reference Code

Fault event	Fault code	Icon	Fault event	Fault code	Icon
Bus start fail	01	x	Battery voltage too high	27	x
Bus over	02	x	Battery voltage too low	28	x
Bus under	03	x	Charger output short	2A	x
Inverter soft start fail	11	x	Over temperature	41	x
Inverter voltage high	12	x	Overload	43	
Inverter voltage Low	13	x	Charger failure	45	x
Inverter output short	14	x	Over input current	49	x

3-8. Warning indicator













Warning	Icon (flashing)	Code	Alarm
Low Battery		bl	Sounding every 2 seconds
Overload		OL	Sounding every second
Over input current		OI	Sounding 2 beep every 10 seconds
Battery is not connected		NC	Sounding every 2 seconds
Over Charge		OC	Sounding every 2 seconds
Site wiring fault		SF	Sounding every 2 seconds
EPO enable		EP	Sounding every 2 seconds
Over temperature		EP	Sounding every 2 seconds
Charger failure		CH	Sounding every 2 seconds
Battery fault		bF	Sounding every 2 seconds
Out of bypass voltage range		bV	(At this time, UPS is off to remind users something wrong with battery)
Bypass frequency unstable		FU	Sounding every 2 seconds
Battery replacement		br	Sounding every 2 seconds
EEPROM error		EE	Sounding every 2 seconds

Note:

“Site Wiring Fault” function can be enabled/disabled via software. Please check software manual for the details.

4. Troubleshooting

If the UPS system does not operate correctly, please solve the problem by using the table below.

Symptom	Possible cause	Remedy
No indication and alarm even though the mains is normal.	The AC input power is not connected well.	Check if input power cord firmly connected to the mains.
	The AC input is connected to the UPS output.	Plug AC input power cord to AC input correctly.
The icon  and the warning code  flash on LCD display and alarm is sounding every 2 seconds.	EPO function is activated	Set the circuit in closed position to disable EPO function.
The icons of  and  and the warning code  flash on LCD display. Alarm is sounding every 2 seconds.	Line and neutral conductors of UPS input are reversed.	Rotate mains power socket by 180° and then connect to UPS system.
The icons of  and  and the warning code  flash on LCD display. Alarm is sounding every 2 seconds.	The external or internal battery is incorrectly connected.	Check if all batteries are connected well.
Fault code is shown as 27 on LCD display and alarm is continuously sounding.	Battery voltage is too high or the charger is fault.	Contact technical support.
Fault code is shown as 28 on LCD display and alarm is continuously sounding.	Battery voltage is too low or the charger is fault.	Contact technical support.
The icons  and  and the warning code  flash on LCD display. Alarm is sounding every second.	UPS is overload	Remove excess loads from UPS output.
	UPS is overloaded. Devices connected to the UPS are fed directly by the electrical network via the Bypass.	Remove excess loads from UPS output.
	After repetitive overloads, the UPS is locked in the Bypass mode. Connected devices are fed directly by the mains.	Remove excess loads from UPS output first. Then shut down the UPS and restart it.
Fault code is shown as 49 on LCD display and alarm is continuously sounding.	UPS is over input current.	Remove excess loads from UPS output.
Fault code is shown as 43 and the icon  is lighting on LCD display. Alarm is continuously sounding.	The UPS shut down automatically because of overload at the UPS output.	Remove excess loads from UPS output and restart it.

Symptom	Possible cause	Remedy
Fault code is shown as 14 on LCD display and alarm is continuously sounding.	The UPS shut down automatically because short circuit occurs on the UPS output.	Check output wiring and if connected devices are in short circuit status.
	A UPS internal fault has occurred. There are two possible results:	Contact technical support.
Fault code is shown as 01, 02, 03, 11, 12, 13 and 41 on LCD display and alarm is continuously sounding.	A UPS internal fault has occurred. There are two possible results: 1. The load is still supplied, but directly from AC power via bypass. 2. The load is no longer supplied by power.	Charge the batteries for at least 5 hours and then check capacity. If the problem still persists, contact technical support.
Battery backup time is shorter than nominal value.	1. Batteries are not fully charged 2. Batteries defect	Charge the batteries for at least 5 hours and then check capacity. If the problem still persists, contact technical support.
Fault code is shown as 2A on LCD display and alarm is continuously sounding.	The short circuit occurs on the charger output.	Check if battery wiring of connected external pack is in short circuit status.
Fault code is shown as 45 on LCD display. At the same time, alarm is continuously sounding.	The charger does not have output and battery voltage is less than 10V/PC.	Contact technical support.

5. Storage and Maintenance

Operation

The UPS system contains no user-serviceable parts. If the battery service life (3~5 years at 25°C ambient temperature) has been exceeded, the batteries must be replaced. In this case, please contact technical support.



Be sure to deliver the spent battery to a recycling facility or ship it to your dealer in the replacement battery packing material

Storage

Before storing, charge the UPS 5 hours. Store the UPS covered and upright in a cool, dry location. During storage, recharge the battery in accordance with the following table:

Storage Temperature	Recharge Frequency	Charging Duration
-25°C ~ 40°C	Every 3 months	1-2 Hours
40°C~ 45°C	Every 1-	1-2 Hours

6. Specifications

		120VAC, 2U Lithium Ion Online UPS			
MODEL NUMBER		VD1000A	VD1500A	VD2000A	VD3000A
CAPACITY	Power rating	1000VA (1000W)	1500VA (1450W)	2000VA (1930W)	3000VA (2880W)
INPUT		55–150VAC* / 50/60Hz auto-sensing			
OUTPUT	Voltage	100**/110/115/120/125 Vac selectable			
	Waveform	Pure sine wave: <=2% THD (linear load), <=4% THD (non-linear load)			
	Frequency	50/60Hz +/-0.1Hz			
	Efficiency	Up to 98%			
	Overload Capacity	> 110% & ≤ 130% for 5 min; > 130% & ≤140% for 30 sec; >140% for 1.5 sec			
BATTERY	Cell type	Sealed, maintenance-free lead acid			
	Cell Configuration	(2) 12V 9AH	(3) 12V 9AH	(4) 12V 9AH	(6) 12V 9AH
	Charger voltage	< 3 hours to 95% with 2A charger current			
	Charger current	2A default, Max 8A Adjustable			
	Recharge time	27.4VDC	41.1VDC	54.8VDC	82.1VDC
PHYSICAL	Dimensions (W x D x H)	17.2 x 15.1 x 3.5**		17.2 x 19 x 3.5**	17.2 x 23.8 x 3.5**
	Weight	25.6	34.2	43.0	60.6
	Line cord	6 ft, 5–15P		6 ft, 5–20P	6 ft, L5–30P
	Receptacles	(8) NEMA 5–15/20R		(8) NEMA 5–15/20R	L5–30R+ (6)5–15/20R
ENVIRONMENT	Temperature	32–104°F (0 ~ 40°C)			
	Altitude	11,500 ft above sea level			
APPROVALS		UL, cUL, RoHS, FCC Class B (1000 (2U), 1500VA), FCC Class A (1000 (1U), 2000, 3000VA), TAA compliant			
WARRANTY		3 years electronics, 3 years battery warranty (USA and Canada)			
COMMUNICATIONS INTERFACE		RS-232, USB, EPO, intelligent slot for optional cards (Web/SNMP)			
INCLUDED IN BOX		Software, horizontal brackets, tower pedestals, user manual			

Note: *Depending on load level. **Derate capacity to 80% when the output voltage is adjusted to 100VAC.

***Rack depth is front bracket to unit panel. Add 1" for depth including front bezel.

		120VAC, 2U Lithium Ion Online UPS		
MODEL NUMBER		VD1500B	VD2000BA	VD3000B
CAPACITY	Power rating	1500VA (1500W)	2000VA (2000W)	3000VA (3000W)
INPUT		110-300 VAC* / 50/60Hz auto-sensing		
OUTPUT	Voltage	200***/208**/220/230/240 Vac selectable		
	Waveform	Pure sine wave: <=2% THD (linear load), <=4% THD (non-linear load)		
	Frequency	50/60Hz +/-0.1Hz		
	Efficiency	Up to 98%		
	Overload Capacity	> 110% & ≤ 130% for 5 min; > 130% & ≤140% for 30 sec; >140% for 1.5 sec		
BATTERY	Cell type	Sealed, maintenance-free lead acid		
	Cell Configuration	(3) 12V 9AH	(4) 12V 9AH	(6) 12V 9AH
	Charger voltage	< 3 hours to 95% with 2A charger current		
	Charger current	2A default, Max 8A Adjustable		
	Recharge time	41.1VDC	54.8VDC	82.1VDC
PHYSICAL	Dimensions (W x D x H)	17.2 x 15.1 x 3.5**	17.2 x 19 x 3.5**	17.2 x 23.8 x 3.5**
	Weight	34.2	43.0	60.6
	Line cord	C14 inlet, 8 ft (2.4 m) L6-20P to C13 line cord	C20 inlet, 8 ft (2.4 m) L6-20P to C19 line cord	
	Receptacles	(8) C13		(1) C19 + (8) C13
ENVIRONMENT	Temperature	32–104°F (0 ~ 40°C)		
	Altitude	11,500 ft above sea level		
APPROVALS		UL, cUL, RoHS, FCC Class B (1000 (2U), 1500VA), FCC Class A (1000 (1U), 2000, 3000VA), TAA compliant		
WARRANTY		3 years electronics, 3 years battery warranty (USA and Canada)		
COMMUNICATIONS INTERFACE		RS-232, USB, EPO, intelligent slot for optional cards (Web/SNMP)		
INCLUDED IN BOX		Software, horizontal brackets, tower pedestals, user manual		

Note: *Depending on load level. **Derate capacity to 80% when the output voltage is adjusted to 100VAC.

***Rack depth is front bracket to unit panel. Add 1" for depth including front bezel.

Output Power Rating Table

Model Name	Input Rating	Output Rating
VD1000A	100-125Vac, 50/60Hz, 12A, 1Ø	100/110/115/120/125Vac, 50/60Hz, 1000VA/1000W, 1Ø, 10/9.1/8.7/8.3/8A
VD1500A	100-125Vac, 50/60Hz, 12A, 1Ø	100/110/115/120/125Vac, 50/60Hz, 1Ø 1500VA/1430W, 12A (@125Vac input) ; 1500VA/1300W, 12.5A (@120Vac input) ; 1500VA/1270W, 13A (@115Vac input) ; 1500VA/1200W, 13.6A (@110Vac input) ; 1350VA/1040W, 13.5A (@100Vac input)
VD2000A	100-125Vac, 50/60Hz, 16A, 1Ø	100/110/115/120/125Vac, 50/60Hz, 1Ø 2000VA/1930W, 16A (@125Vac input) ; 2000VA/1850W, 16.7A (@120Vac input) ; 2000VA/1740W, 17.4A (@115Vac input) ; 2000VA/1640W, 18.2A (@110Vac input) ; 1800VA/1500W, 18A (@100Vac input)
VD3000A	100-125Vac, 50/60Hz, 24A, 1Ø	100/110/115/120/125Vac, 50/60Hz, 1Ø 3000VA/2850W, 24A (@125Vac input) ; 3000VA/2740W, 25A (@120Vac input) ; 3000VA/2650W, 26.1A (@115Vac input) ; 3000VA/2500W, 27.3A (@110Vac input) ; 2700VA/2300W, 27A (@100Vac input)

Runtime Chart (internal battery)

Model	VD1000A	VD1500A	VD2000A	VD3000A
Battery	(9Ah x 2)	(9Ah x 3)	(9Ah x 4)	(9Ah x 6)
Load Percentage				
100.00%	2.43	2.57	2.43	2.64
90.00%	3.19	3.36	3.19	3.36
80.00%	4.14	4.34	4.06	4.34
70.00%	5.31	5.42	5.31	5.53
60.00%	6.93	6.93	7.06	7.33
50.00%	9.44	9.46	9.56	9.79
40.00%	12.92	12.89	13.20	13.51
30.00%	18.52	18.43	19.12	19.90
20.00%	29.90	29.44	31.06	32.61
10.00%	63.67	61.16	68.38	72.53

Runtime Chart (internal battery)

Model	VXBP4	VXBP5	VSBP6	VXBP7
Used with UPS Models	VD1500A/ VD1500B		VD2000A/VD2000B	VD3000A/VD3000B
Battery Type	12V 9Ah	12V 9Ah	12V 9Ah	12V 9Ah
Battery Numbers	6	12	8	12
Dimensions (WxDxH)	17.2 x 18.9 x 3.5 in	17.2 x 23.6 x 3.5 in	17.2 x 18.9 x 3.5 in	17.2 x 23.6 x 3.5 in
Net Weight	58.1 lbs	104.4 lbs	74.6 lbs	104.4 lbs

NOTE: Battery pack should be used with corresponding UPS.

OBTAINING SERVICE

If the UPS requires Service:

1. Use the TROUBLESHOOTING section in this manual to eliminate obvious causes.
2. Verify there are no circuit breakers tripped.
3. Call CPI Technical Support at 800-834-4969. Technical support inquiries can also be made at techsupport@chatsworth.com. Please have the following information available BEFORE calling the Technical Support Department:
 - Ship to address
 - The serial number of the unit.
 - Where and when the unit was purchased.
 - All of the model information about your UPS.
 - Any information on the failure, including LED's that may or may not be illuminated.
 - A description of the protected equipment, including model numbers if possible.
4. Technical Support will ask you for the above information and, if possible, help solve your problem over the phone. In the event that the unit requires factory service, the technician will issue you a Return Material Authorization number (RMA).

RETURNS AND REPAIRS

No products or part thereof shall be returned to CPI unless the customer first obtains a Return Material Authorization (RMA) Number from a CPI customer service representative. This number must appear clearly and prominently on all shipping containers. Containers without the labels will not be accepted.

If you are returning the UPS to CPI for service, please follow these procedures:

1. Pack the UPS in its original packaging. If the original packaging is no longer available, ask the Technical Support Technician about obtaining a replacement set of packaging material. It is important to pack the UPS properly in order to avoid damage in transit.
***Never use Styrofoam beads for a packing material.**
2. Mark the RMA number on the outside of all packages. CPI cannot accept any package without the RMA number noted on the outside of the boxes.
3. Return the UPS by an insured, prepaid carrier to the address provided by the Technician.
4. Refer to the Warranty statements in this manual for additional details on items covered.

RMA expires 30 Days after issuance!

Standard Limited Warranty – CPI-Branded Hardware Products

Chatsworth Products, Inc. (CPI) warrants all CPI-branded hardware products (LS-Series Uninterruptible Power Supplies) to be free from defects in material and/or workmanship (CPI's Standard Limited Warranty) for a period of three (3) years (USA & Canada) and one (1) year (outside USA & Canada) following the date of purchase (the Original Warranty Period).

The customer must contact CPI in writing or by oral communication confirmed in writing within the Original Warranty Period to report a product that the customer claims is defective. CPI reserves the sole and absolute right to determine whether or not the product or any part thereof is defective. In the event a product (or any part thereof) is determined by CPI to be defective (an Accepted Claim), CPI will provide a re-manufactured or replacement product or part (the Replacement Product) at no cost to the customer and issue a Return Material Authorization (RMA) number.

In the case of an Accepted Claim, the customer shall be responsible for shipping back the defective product to CPI under the provided RMA number within 30 days. Any exceptions to this return policy must be authorized by CPI in writing in advance. Freight charges for the return shipment of the defective product for an Accepted Claim shall be borne by the customer, unless the defect is reported by the customer to CPI in writing within the first 30 days following the customer's receipt of the original product. Any Replacement Product that has been provided under an Accepted Claim will be subject to CPI's Standard Limited Warranty for the remaining Warranty Period applicable to the original product or 90 days following the date of replacement, whichever occurs later.

CPI's Standard Limited Warranty and Extended Limited Warranty do not extend to CPI-branded hardware products that have been subjected to abuse, misuse, neglect, accident, improper use, or improper installation, operation, repair and maintenance (except to the extent provided by CPI authorized personnel), nor to products that have been altered or modified in any way by anyone other than CPI authorized personnel, in which case CPI's Standard Limited Warranty or Extended Limited Warranty shall be null and void. In no event will CPI be liable for consequential damages, for loss, damage or expense directly or indirectly arising from the use of any of its branded products, for any inability to use materials or from any other cause.

THESE LIMITED WARRANTY PROVISIONS ARE THE EXCLUSIVE WARRANTIES FOR ANY CPI-BRANDED HARDWARE PRODUCTS AND SET FORTH THE EXCLUSIVE REMEDIES AND PROCEDURES FOR CLAIMS UNDER CPI'S STANDARD LIMITED WARRANTY AND EXTENDED LIMITED WARRANTY.

CPI'S STANDARD LIMITED WARRANTY AND EXTENDED LIMITED WARRANTY APPLY TO CPI-BRANDED HARDWARE PRODUCTS ONLY.

DISCLAIMER OF WARRANTY: EXCEPT AS EXPRESSLY SET FORTH HEREIN, CPI MAKES NO OTHER WARRANTIES, EXPRESS OR IMPLIED, INCLUDING, WITHOUT LIMITATION, ANY WARRANTIES OF FITNESS FOR A PARTICULAR USE OR PURPOSE, MERCHANTABILITY, OR NON-INFRINGEMENT OF ANY INTELLECTUAL PROPERTY RIGHTS.